



Quick-Connect Fluid Fittings **PLUMBING. SIMPLIFIED.**



For applications where valved
technology is not required...

PRO-COMPACT SERIES

Connector size comparable
to threaded AN fittings!
See page 43



www.jiffy-titemotorsports.com



The Fast, Safe & Reliable Fitting

Jiffy-tite® has been the preferred manufacturer of fluid connectors for the industrial and original equipment manufacturer sector of the automotive industry since 1963. There are over 400 million Jiffy-tite devices in service in more than 20 brands of vehicles worldwide including Chevrolet, Ford,

Cadillac, Dodge, Mercedes-Benz, Harley Davidson, Caterpillar and more. Proven by years of research and development in the lab, on the track, and on the dyno, Jiffy-tite proudly offers a full line of motorsports quick-connect fluid fittings that are second to none, offering by far the quickest connection in the industry.

Designed for racers by racers, these revolutionary quick-connect fluid fittings provide unsurpassed performance under extreme racing conditions and can replace nearly any fitting in any location. Made of lightweight, high quality aircraft aluminum with brass valves and stainless steel ball bearings, Jiffy-tite fittings are lightweight and corrosion resistant for long life.

Most importantly, Jiffy-tite's state-of-the-art technology provides far better seal integrity than any other product on the market. Unlike threaded fittings, which always present a risk for fluid leaks or hot oil spills, Jiffy-tite's unique design provides a 100% leak proof seal. Even when disconnected, both fittings prevent fluid leakage.



Discover the Jiffy-tite Advantage

- 100% leak proof – when connected or disconnected, both connectors prevent fluid leakage
- High flow, minimum restriction
- Easily connects or disconnects by hand in seconds – no tools needed!
- Automatic shut-off when disconnected provides added safety feature
- Lightweight
- Excellent wear resistance
- Ruggedly constructed from 6061-T6 aluminum with brass valves and stainless steel bearings
- Ribbed collar provides slip-proof use
- 360° swivel
- Available for virtually any fuel, water, oil, or transmission applications
- Replaces any fitting in any location
- Sockets are available in black or gold anodized finish
- Ideal for fuel sampling
- Available valved or non-valved
- Fluid flows bi-directionally through both the socket and the plug
- Made in the USA

Jiffy-tite fittings are fast and easy to use:

Quick-connect fittings connect or disconnect in seconds without requiring any tools.

To connect, pull back on the socket collar, insert the plug and release the collar.

To disconnect, pull back on the socket collar. The spring-loaded valve will release the male plug.

Valved technology on both the socket and the plug provide a 100% leak proof seal, with minimum flow restriction for virtually any fuel, water, oil, or transmission system on the market today. The ribbed collar ensures a slip-proof connection.



Internal View of a Standard Jiffy-tite Socket

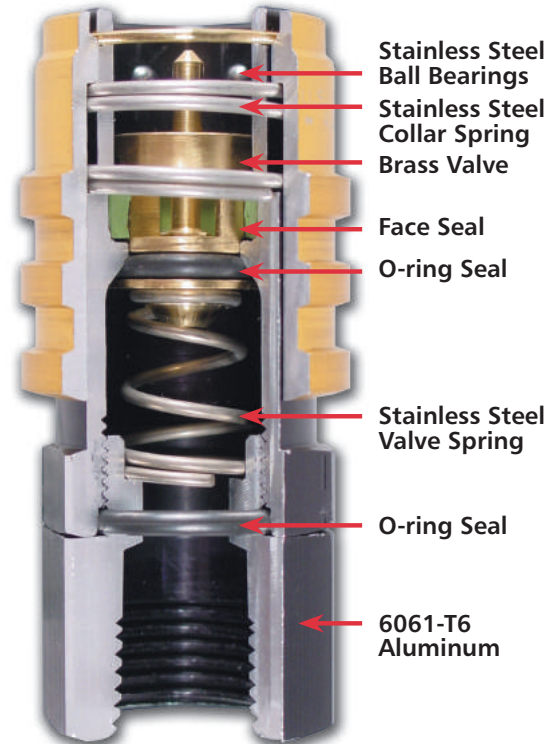

With Jiffy-tite you can avoid these common problems associated with traditional threaded fittings:

1. Stripping
2. Cross-threading
3. Over-tightening – leading to breakage
4. Forgetting to tighten
5. Stripping the hex – by using the incorrect tool
6. Scratching the fitting by frequent wrenching – destroys the aesthetics of the fitting.

SPECS

FLOW INFORMATION

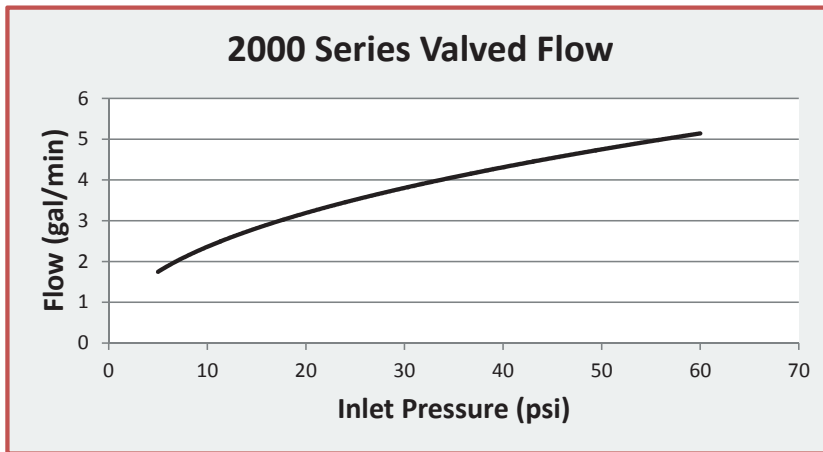

Jiffy-tite Quick-Connect Fluid Fittings using standard stoddard solvent with a specific gravity of .750 and 80° fluid temperature through a -6AN hose. Refer to page 6.

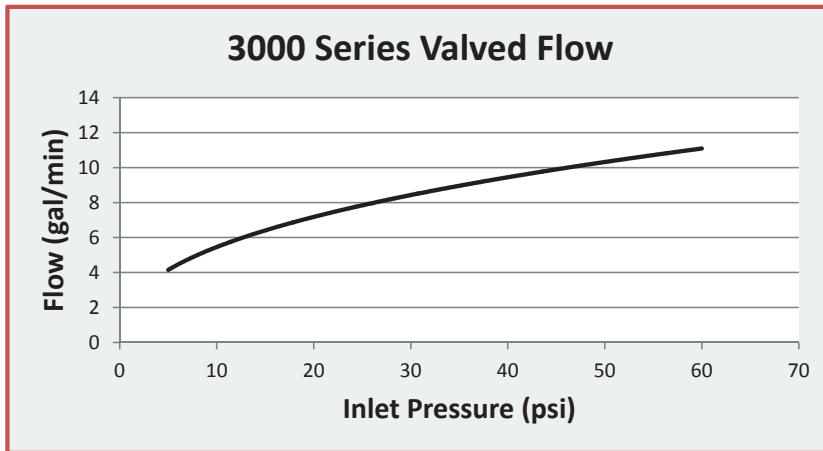

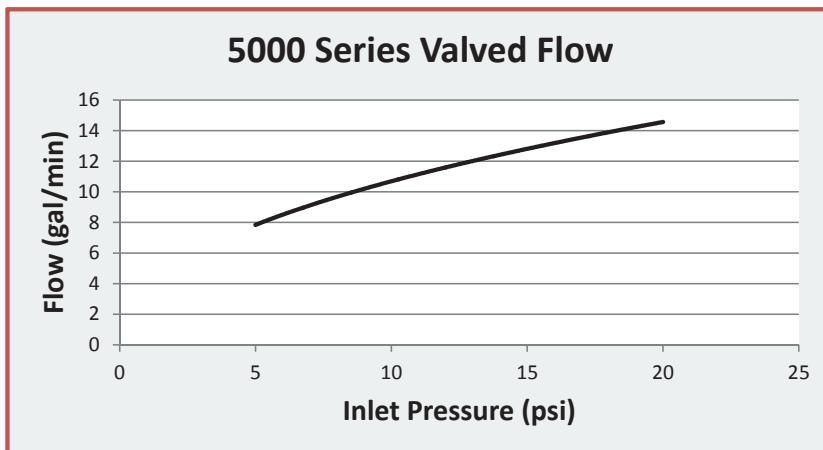

Jiffy-tite Quick-Connect Fluid Fittings using standard stoddard solvent with a specific gravity of .750 and 80° fluid temperature through a -8AN hose. Refer to page 16.



Jiffy-tite Quick-Connect Fluid Fittings using standard stoddard solvent with a specific gravity of .750 and 80° fluid temperature through a -10AN hose. Refer to page 25.

PRESSURE Maximum Operating Pressure : 200 PSI 1.38 MPa	TEMPERATURE -40° - 350° Fahrenheit -40° - 177° C
---	---

SEAL COMPATIBILITY

FLUOROCARBON (FKM) SEAL 	Oil	Transmission Fluid
	Water	E85 (Ethanol Fuel Blend)
	Fuel	Diesel
NITRILE (NBR) SEAL 	Alcohol (Fuel)	
ETHYLENE PROPYLENE (EPDM) SEAL 	Nitromethane	Brake Fluid
	Methanol (Methyl Alcohol)	Ethanol (Ethyl Alcohol)

*Note: these fittings should not be used on brake lines.



TECH TIP

Jiffy-tite Quick-Connects are available from your performance parts retailer. Check our website for a list of current distributors.
www.jiffy-titemotorsports.com



AN 37° THREAD SIZES

Pictured are actual sizes of common AN thread sizes. To determine what size fitting you have, lay your fitting over the appropriate drawing.

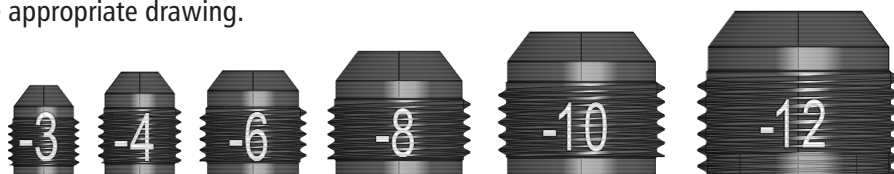

AN SIZE	METAL TUBE O.D.	THREAD SIZE
-3	3/16"	3/8-24 UNF
-4	1/4"	7/16-20 UNF
-6	3/8"	9/16-18 UNF
-8	1/2"	3/4-16 UNF
-10	5/8"	7/8-14 UNF
-12	3/4"	1-1/16-12 UN

NPT PIPE THREADS

Pictured are actual sizes of common NPT thread sizes. To determine what size fitting you have, lay your fitting over the appropriate drawing.

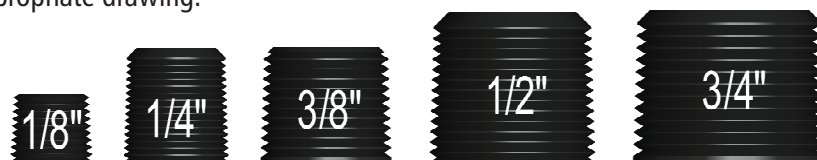

NPT PIPE THREAD SIZE	THREADS PER INCH	FITTING I.D.	CLOSEST AN FITTING SIZE
1/8"	27	1/8"	-4
1/4"	18	1/4"	-6
3/8"	18	3/8"	-8
1/2"	14	1/2"	-10
3/4"	14	3/4"	-12

MALE O-RING BOSS SEAL (ORB) THREAD SIZES

Pictured are actual sizes of common SAE male o-ring boss seal thread sizes. To determine what size fitting you have, lay your fitting over the appropriate drawing.



AN SIZE	METAL TUBE O.D.	THREAD SIZE
-4	1/4"	7/16-20 UNF
-6	3/8"	9/16-18 UNF
-8	1/2"	3/4-16 UNF
-10	5/8"	7/8-14 UNF
-12	3/4"	1-1/16-12 UN

2000

2000 Series are available in the following sizes:

- -3 AN to -6 AN 37° Male and Female
- 1/8" to 1/4" Male and Female NPT
- -3 AN to -6 AN Hose Barb
- -4 to -6 Push to Lock Hose Barb
- -4 AN to -6 AN Reusable Nut Hose End
- -4 to -6 Male O-ring Boss Seal
- -4 AN to -6 AN Lanyard Reusable Nut Hose End and Lanyard 37° Male AN

All 2000 series are available in straight, 45° and 90°.

All fittings are also available non-valved to allow for a 100% flow through application.

Caps, plugs, and C clips are also available.

All sockets and plugs in the same series are interchangeable.

Flow Information

Jiffy-tite Quick-Connect Fluid Fittings using standard stoddard solvent with a specific gravity of .750 and 80° fluid temperature through a -6AN hose.

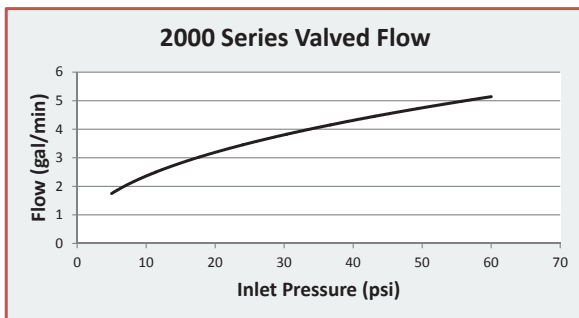

DIMENSIONS

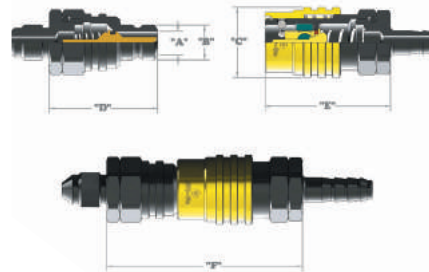

STRAIGHT 2000 SERIES

A	B	C	D	E	F
.24	.37	.75	1.17	1.35	2.13

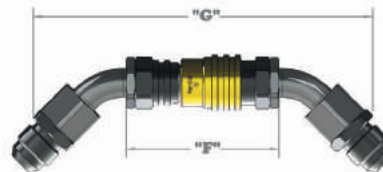
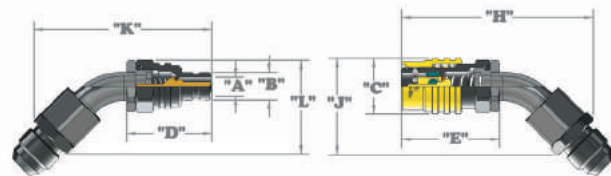

45° 2000 SERIES

A	B	C	D	E	F	G	H	J	K	L
.24	.37	.75	1.15	1.32	2.07	4.61	2.61	1.30	2.42	1.27

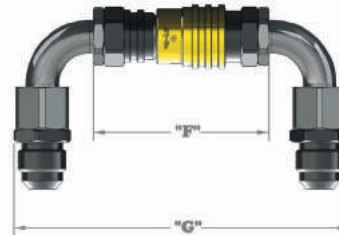
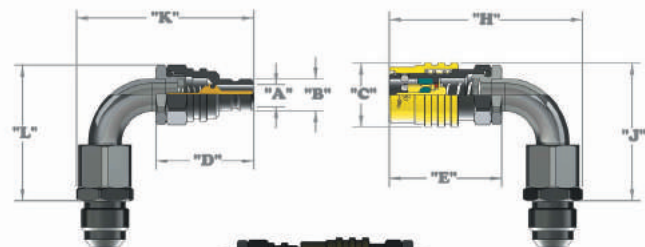

90° 2000 SERIES

A	B	C	D	E	F	G	H	J	K	L
.24	.37	.75	1.15	1.32	2.07	3.96	2.21	1.62	2.10	1.59

SOCKETS

Male O-Ring Boss Seal (ORB) Straight - Gold							
Size	FKM	Nitrile	EPDM	Non-Valve FKM	Non-Valve Nitrile	Non-Valve EPDM	
-4	21104	21104B	21104F	21104A	21104C	21104AF	
-6	21106	21106B	21106F	21106A	21106C	21106AF	
Male O-Ring Boss Seal (ORB) 45° - Gold							
Size	FKM	Nitrile	EPDM	Non-Valve FKM	Non-Valve Nitrile	Non-Valve EPDM	
-4	21104D	21104BD	21104FD	21104AD	21104CD	21104AFD	
-6	21106D	21106BD	21106FD	21106AD	21106CD	21106AFD	
Male O-Ring Boss Seal (ORB) 90° - Gold							
Size	FKM	Nitrile	EPDM	Non-Valve FKM	Non-Valve Nitrile	Non-Valve EPDM	
-4	21104E	21104BE	21104FE	21104AE	21104CE	21104AFE	
-6	21106E	21106BE	21106FE	21106AE	21106CE	21106AFE	
Male O-Ring Boss Seal (ORB) Straight - Black							
Size	FKM	Nitrile	EPDM	Non-Valve FKM	Non-Valve Nitrile	Non-Valve EPDM	
-4	21104J	21104BJ	21104FJ	21104AJ	21104CJ	21104AFJ	
-6	21106J	21106BJ	21106FJ	21106AJ	21106CJ	21106AFJ	
Male O-Ring Boss Seal (ORB) 45° - Black							
Size	FKM	Nitrile	EPDM	Non-Valve FKM	Non-Valve Nitrile	Non-Valve EPDM	
-4	21104JD	21104BJD	21104FJD	21104AJD	21104CJD	21104AFJD	
-6	21106JD	21106BJD	21106FJD	21106AJD	21106CJD	21106AFJD	
Male O-Ring Boss Seal (ORB) 90° - Black							
Size	FKM	Nitrile	EPDM	Non-Valve FKM	Non-Valve Nitrile	Non-Valve EPDM	
-4	21104JE	21104BJE	21104FJE	21104AJE	21104CJE	21104AFJE	
-6	21106JE	21106BJE	21106FJE	21106AJE	21106CJE	21106AFJE	
FEMALE 37° AN Straight - Gold							
Size	FKM	Nitrile	EPDM	Non-Valve FKM	Non-Valve Nitrile	Non-Valve EPDM	
-4 AN	21304	21304B	21304F	21304A	21304C	21304AF	
-6 AN	21306	21306B	21306F	21306A	21306C	21306AF	
FEMALE 37° AN 45 Degree - Gold - Swivel							
Size	FKM	Nitrile	EPDM	Non-Valve FKM	Non-Valve Nitrile	Non-Valve EPDM	
-4 AN	21304D	21304BD	21304FD	21304AD	21304CD	21304AFD	
-6 AN	21306D	21306BD	21306FD	21306AD	21306CD	21306AFD	
FEMALE 37° AN 90 Degree - Gold - Swivel							
Size	FKM	Nitrile	EPDM	Non-Valve FKM	Non-Valve Nitrile	Non-Valve EPDM	
-4 AN	21304E	21304BE	21304FE	21304AE	21304CE	21304AFE	
-6 AN	21306E	21306BE	21306FE	21306AE	21306CE	21306AFE	
FEMALE 37° AN Straight - Black							
Size	FKM	Nitrile	EPDM	Non-Valve FKM	Non-Valve Nitrile	Non-Valve EPDM	
-4 AN	21304J	21304BJ	21304FJ	21304AJ	21304CJ	21304AFJ	
-6 AN	21306J	21306BJ	21306FJ	21306AJ	21306CJ	21306AFJ	

SOCKETS

FEMALE 37° AN 45 Degree - Black - Swivel							
Size	FKM	Nitrile	EPDM	Non-Valve FKM	Non-Valve Nitrile	Non-Valve EPDM	
-4 AN	21304JD	21304BJD	21304FJD	21304AJD	21304CJD	21304AFJD	
-6 AN	21306JD	21306BJD	21306FJD	21306AJD	21306CJD	21306AFJD	
FEMALE 37° AN 90 Degree - Black - Swivel							
Size	FKM	Nitrile	EPDM	Non-Valve FKM	Non-Valve Nitrile	Non-Valve EPDM	
-4 AN	21304JE	21304BJE	21304FJE	21304AJE	21304CJE	21304AFJE	
-6 AN	21306JE	21306BJE	21306FJE	21306AJE	21306CJE	21306AFJE	
MALE 37° AN Straight - Gold							
Size	FKM	Nitrile	EPDM	Non-Valve FKM	Non-Valve Nitrile	Non-Valve EPDM	
-3 AN	21403	21403B	21403F	21403A	21403C	21403AF	
-4 AN	21404	21404B	21404F	21404A	21404C	21404AF	
-6 AN	21406	21406B	21406F	21406A	21406C	21406AF	
MALE 37° AN 45 Degree - Gold							
Size	FKM	Nitrile	EPDM	Non-Valve FKM	Non-Valve Nitrile	Non-Valve EPDM	
-3 AN	21403D	21403BD	21403FD	21403AD	21403CD	21403AFD	
-4 AN	21404D	21404BD	21404FD	21404AD	21404CD	21404AFD	
-6 AN	21406D	21406BD	21406FD	21406AD	21406CD	21406AFD	
MALE 37° AN 90 Degree - Gold							
Size	FKM	Nitrile	EPDM	Non-Valve FKM	Non-Valve Nitrile	Non-Valve EPDM	
-3 AN	21403E	21403BE	21403FE	21403AE	21403CE	21403AFE	
-4 AN	21404E	21404BE	21404FE	21404AE	21404CE	21404AFE	
-6 AN	21406E	21406BE	21406FE	21406AE	21406CE	21406AFE	
Lanyard 37° AN Male - Gold							
Size	FKM	Nitrile	EPDM	Non-Valve FKM	Non-Valve Nitrile	Non-Valve EPDM	
-4AN	21404M	21404BM	21404FM	21404AM	21404CM	21404AFM	
-6AN	21406M	21406BM	21406FM	21406AM	21406CM	21406AFM	
MALE 37° AN Straight - Black							
Size	FKM	Nitrile	EPDM	Non-Valve FKM	Non-Valve Nitrile	Non-Valve EPDM	
-3 AN	21403J	21403BJ	21403FJ	21403AJ	21403CJ	21403AFJ	
-4 AN	21404J	21404BJ	21404FJ	21404AJ	21404CJ	21404AFJ	
-6 AN	21406J	21406BJ	21406FJ	21406AJ	21406CJ	21406AFJ	
MALE 37° AN 45 Degree - Black							
Size	FKM	Nitrile	EPDM	Non-Valve FKM	Non-Valve Nitrile	Non-Valve EPDM	
-3 AN	21403JD	21403BJD	21403FJD	21403AJD	21403CJD	21403AFJD	
-4 AN	21404JD	21404BJD	21404FJD	21404AJD	21404CJD	21404AFJD	
-6 AN	21406JD	21406BJD	21406FJD	21406AJD	21406CJD	21406AFJD	
MALE 37° AN 90 Degree - Black							
Size	FKM	Nitrile	EPDM	Non-Valve FKM	Non-Valve Nitrile	Non-Valve EPDM	
-3 AN	21403JE	21403BJE	21403FJE	21403AJE	21403CJE	21403AFJE	
-4 AN	21404JE	21404BJE	21404FJE	21404AJE	21404CJE	21404AFJE	
-6 AN	21406JE	21406BJE	21406FJE	21406AJE	21406CJE	21406AFJE	

SOCKETS

Lanyard 37° AN Male - Black						
Size	FKM	Nitrile	EPDM	Non-Valve FKM	Non-Valve Nitrile	Non-Valve EPDM
-4AN	21404MJ	21404BMJ	21404FMJ	21404AMJ	21404CMJ	21404AFMJ
-6AN	21406MJ	21406BMJ	21406FMJ	21406AMJ	21406CMJ	21406AFMJ
Hose Barb Straight - Gold						
Size	FKM	Nitrile	EPDM	Non-Valve FKM	Non-Valve Nitrile	Non-Valve EPDM
-3 AN	21503	21503B	21503F	21503A	21503C	21503AF
-4 AN	21504	21504B	21504F	21504A	21504C	21504AF
-5 AN	21505	21505B	21505F	21505A	21505C	21505AF
-6 AN	21506	21506B	21506F	21506A	21506C	21506AF
Hose Barb 45° - Gold						
Size	FKM	Nitrile	EPDM	Non-Valve FKM	Non-Valve Nitrile	Non-Valve EPDM
-3 AN	21503D	21503BD	21503FD	21503AD	21503CD	21503AFD
-4 AN	21504D	21504BD	21504FD	21504AD	21504CD	21504AFD
-5 AN	21505D	21505BD	21505FD	21505AD	21505CD	21505AFD
-6 AN	21506D	21506BD	21506FD	21506AD	21506CD	21506AFD
Hose Barb 90° - Gold						
Size	FKM	Nitrile	EPDM	Non-Valve FKM	Non-Valve Nitrile	Non-Valve EPDM
-3 AN	21503E	21503BE	21503FE	21503AE	21503CE	21503AFE
-4 AN	21504E	21504BE	21504FE	21504AE	21504CE	21504AFE
-5 AN	21505E	21505BE	21505FE	21505AE	21505CE	21505AFE
-6 AN	21506E	21506BE	21506FE	21506AE	21506CE	21506AFE
Hose Barb Straight - Black						
Size	FKM	Nitrile	EPDM	Non-Valve FKM	Non-Valve Nitrile	Non-Valve EPDM
-3 AN	21503J	21503BJ	21503FJ	21503AJ	21503CJ	21503AFJ
-4 AN	21504J	21504BJ	21504FJ	21504AJ	21504CJ	21504AFJ
-5 AN	21505J	21505BJ	21505FJ	21505AJ	21505CJ	21505AFJ
-6 AN	21506J	21506BJ	21506FJ	21506AJ	21506CJ	21506AFJ
Hose Barb 45° - Black						
Size	FKM	Nitrile	EPDM	Non-Valve FKM	Non-Valve Nitrile	Non-Valve EPDM
-3 AN	21503JD	21503BJD	21503FJD	21503AJD	21503CJD	21503AFJD
-4 AN	21504JD	21504BJD	21504FJD	21504AJD	21504CJD	21504AFJD
-5 AN	21505JD	21505BJD	21505FJD	21505AJD	21505CJD	21505AFJD
-6 AN	21506JD	21506BJD	21506FJD	21506AJD	21506CJD	21506AFJD
Hose Barb 90° - Black						
Size	FKM	Nitrile	EPDM	Non-Valve FKM	Non-Valve Nitrile	Non-Valve EPDM
-3 AN	21503JE	21503BJE	21503FJE	21503AJE	21503CJE	21503AFJE
-4 AN	21504JE	21504BJE	21504FJE	21504AJE	21504CJE	21504AFJE
-5 AN	21505JE	21505BJE	21505FJE	21505AJE	21505CJE	21505AFJE
-6 AN	21506JE	21506BJE	21506FJE	21506AJE	21506CJE	21506AFJE
Push To Lock Hose Barb Straight - Gold						
Size	FKM	Nitrile	EPDM	Non-Valve FKM	Non-Valve Nitrile	Non-Valve EPDM
-4	21504P	21504BP	21504FP	21504AP	21504CP	21504AFP
-6	21506P	21506BP	21506FP	21506AP	21506CP	21506AFP



SOCKETS

Push To Lock Hose Barb 45° - Gold							
Size	FKM	Nitrile	EPDM	Non-Valve FKM	Non-Valve Nitrile	Non-Valve EPDM	
-4	21504PD	21504BPD	21504FPD	21504APD	21504CPD	21504AFPD	
-6	21506PD	21506BPD	21506FPD	21506APD	21506CPD	21506AFPD	
Push To Lock Hose Barb 90° - Gold							
Size	FKM	Nitrile	EPDM	Non-Valve FKM	Non-Valve Nitrile	Non-Valve EPDM	
-4	21504PE	21504BPE	21504FPE	21504APE	21504CPE	21504AFPE	
-6	21506PE	21506BPE	21506FPE	21506APE	21506CPE	21506AFPE	
Push To Lock Hose Barb Straight - Black							
Size	FKM	Nitrile	EPDM	Non-Valve FKM	Non-Valve Nitrile	Non-Valve EPDM	
-4	21504PJ	21504BPJ	21504FPJ	21504APJ	21504CPJ	21504AFPJ	
-6	21506PJ	21506BPJ	21506FPJ	21506APJ	21506CPJ	21506AFPJ	
Push To Lock Hose Barb 45° - Black							
Size	FKM	Nitrile	EPDM	Non-Valve FKM	Non-Valve Nitrile	Non-Valve EPDM	
-4	21504PJD	21504BPJD	21504FPJD	21504APJD	21504CPJD	21504AFPJD	
-6	21506PJD	21506BPJD	21506FPJD	21506APJD	21506CPJD	21506AFPJD	
Push To Lock Hose Barb 90° - Black							
Size	FKM	Nitrile	EPDM	Non-Valve FKM	Non-Valve Nitrile	Non-Valve EPDM	
-4	21504PJE	21504BPJE	21504FPJE	21504APJE	21504CPJE	21504AFPJE	
-6	21506PJE	21506BPJE	21506FPJE	21506APJE	21506CPJE	21506AFPJE	
Reusable Nut Hose End Straight - Gold							
Size	FKM	Nitrile	EPDM	Non-Valve FKM	Non-Valve Nitrile	Non-Valve EPDM	
-4 AN	21604	21604B	21604F	21604A	21604C	21604AF	
-6 AN	21606	21606B	21606F	21606A	21606C	21606AF	
Reusable Nut Hose End 45° - Gold							
Size	FKM	Nitrile	EPDM	Non-Valve FKM	Non-Valve Nitrile	Non-Valve EPDM	
-4 AN	21604D	21604BD	21604FD	21604AD	21604CD	21604AFD	
-6 AN	21606D	21606BD	21606FD	21606AD	21606CD	21606AFD	
Reusable Nut Hose End 90° - Gold							
Size	FKM	Nitrile	EPDM	Non-Valve FKM	Non-Valve Nitrile	Non-Valve EPDM	
-4 AN	21604E	21604BE	21604FE	21604AE	21604CE	21604AFE	
-6 AN	21606E	21606BE	21606FE	21606AE	21606CE	21606AFE	
Reusable Nut Hose End Straight - Black							
Size	FKM	Nitrile	EPDM	Non-Valve FKM	Non-Valve Nitrile	Non-Valve EPDM	
-4 AN	21604J	21604BJ	21604FJ	21604AJ	21604CJ	21604AFJ	
-6 AN	21606J	21606BJ	21606FJ	21606AJ	21606CJ	21606AFJ	
Reusable Nut Hose End 45° - Black							
Size	FKM	Nitrile	EPDM	Non-Valve FKM	Non-Valve Nitrile	Non-Valve EPDM	
-4 AN	21604JD	21604BJD	21604FDJ	21604AFJD	21604CJD	21604AFJD	
-6 AN	21606JD	21606BJD	21606FDJ	21606AJD	21606CJD	21606AFJD	
Reusable Nut Hose End 90° - Black							
Size	FKM	Nitrile	EPDM	Non-Valve FKM	Non-Valve Nitrile	Non-Valve EPDM	
-4 AN	21604JE	21604BJE	21604FJE	21604AJE	21604CJE	21604AFJE	
-6 AN	21606JE	21606BJE	21606FJE	21606AJE	21606CJE	21606AFJE	

SOCKETS

Lanyard Reusable Nut Hose End - Gold

Size	FKM	Nitrile	EPDM	Non-Valve FKM	Non-Valve Nitrile	Non-Valve EPDM
-4 AN	21604M	21604BM	21604FM	21604AM	21604CM	21604AFM
-6 AN	21606M	21606BM	21606FM	21606AM	21606CM	21606AFM



Lanyard Reusable Nut Hose End - Black

Size	FKM	Nitrile	EPDM	Non-Valve FKM	Non-Valve Nitrile	Non-Valve EPDM
-4 AN	21604MJ	21604BMJ	21604FMJ	21604AMJ	21604CMJ	21604AFMJ
-6 AN	21606MJ	21606BMJ	21606FMJ	21606AMJ	21606CMJ	21606AFMJ

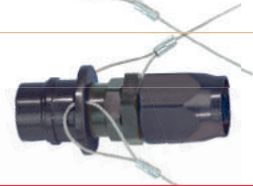

Female NPT Straight - Gold

Size	FKM	Nitrile	EPDM	Non-Valve FKM	Non-Valve Nitrile	Non-Valve EPDM
1/8"	21702	21702B	21702F	21702A	21702C	21702AF
1/4"	21704	21704B	21704F	21704A	21704C	21704AF



Female NPT 45° - Gold

Size	FKM	Nitrile	EPDM	Non-Valve FKM	Non-Valve Nitrile	Non-Valve EPDM
1/8"	21702D	21702BD	21702FD	21702AD	21702CD	21702AFD
1/4"	21704D	21704BD	21704FD	21704AD	21704CD	21704AFD



Female NPT 90° - Gold

Size	FKM	Nitrile	EPDM	Non-Valve FKM	Non-Valve Nitrile	Non-Valve EPDM
1/8"	21702E	21702BE	21702FE	21702AE	21702CE	21702AFE
1/4"	21704E	21704BE	21704FE	21704AE	21704CE	21704AFE



Female NPT Straight - Black

Size	FKM	Nitrile	EPDM	Non-Valve FKM	Non-Valve Nitrile	Non-Valve EPDM
1/8"	21702J	21702BJ	21702FJ	21702AJ	21702CJ	21702AFJ
1/4"	21704J	21704BJ	21704FJ	21704AJ	21704CJ	21704AFJ



Female NPT 45° - Black

Size	FKM	Nitrile	EPDM	Non-Valve FKM	Non-Valve Nitrile	Non-Valve EPDM
1/8"	21702JD	21702BJD	21702FJD	21702AJD	21702CJD	21702AFJD
1/4"	21704JD	21704BJD	21704FJD	21704AJD	21704CJD	21704AFJD



Female NPT 90° - Black

Size	FKM	Nitrile	EPDM	Non-Valve FKM	Non-Valve Nitrile	Non-Valve EPDM
1/8"	21704JE	21704BJE	21704FJE	21704AJE	21704CJE	21704AFJE
1/4"	21704JE	21704BJE	21704FJE	21704AJE	21704CJE	21704AFJE



Male NPT Straight - Gold

Size	FKM	Nitrile	EPDM	Non-Valve FKM	Non-Valve Nitrile	Non-Valve EPDM
1/8"	21802	21802B	21802F	21802A	21802C	21802AF
1/4"	21804	21804B	21804F	21804A	21804C	21804AF



Male NPT 45° - Gold

Size	FKM	Nitrile	EPDM	Non-Valve FKM	Non-Valve Nitrile	Non-Valve EPDM
1/8"	21802D	21802BD	21802FD	21802AD	21802CD	21802AFD
1/4"	21804D	21804BD	21804FD	21804AD	21804CD	21804AFD







Male NPT 90° - Gold

Size	FKM	Nitrile	EPDM	Non-Valve FKM	Non-Valve Nitrile	Non-Valve EPDM
1/8"	21802E	21802BE	21802FE	21802AE	21802CE	21802AFE
1/4"	21804E	21804BE	21804FE	21804AE	21804CE	21804AFE



SOCKETS

Male NPT Straight - Black							
Size	FKM	Nitrile	EPDM	Non-Valve FKM	Non-Valve Nitrile	Non-Valve EPDM	
1/8"	21802J	21802BJ	21802FJ	21802AJ	21802CJ	21802AFJ	
1/4"	21804J	21804BJ	21804FJ	21804AJ	21804CJ	21804AFJ	
Male NPT 45° - Black							
Size	FKM	Nitrile	EPDM	Non-Valve FKM	Non-Valve Nitrile	Non-Valve EPDM	
1/8"	21802JD	21802BJD	21802FJD	21802AJD	21802CJD	21802AFJD	
1/4"	21804JD	21804BJD	21804FJD	21804AJD	21804CJD	21804AFJD	
Male NPT 90° - Black							
Size	FKM	Nitrile	EPDM	Non-Valve FKM	Non-Valve Nitrile	Non-Valve EPDM	
1/8"	21802JE	21802BJE	21802FJE	21802AJE	21802CJE	21802AFJE	
1/4"	21804JE	21804BJE	21804FJE	21804AJE	21804CJE	21804AFJE	
2000 Series Socket Cap				2000 Series Plug Cap			
MS2000P	Fits Any 2000 Series Socket			MS2000C	Fits Any 2000 Series Plug		
							

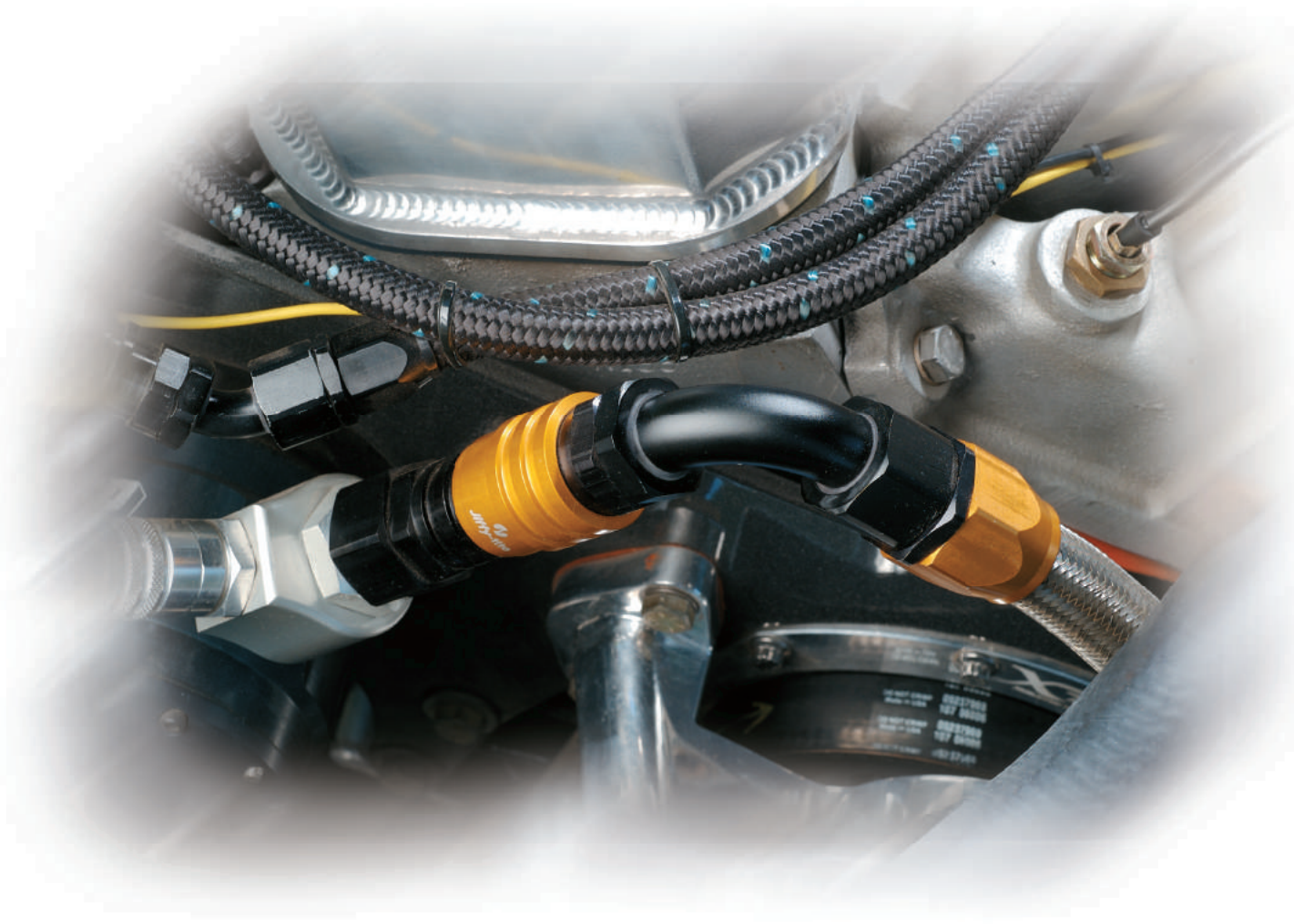

PLUGS









Male O-Ring Boss Seal (ORB) Straight							
Size	FKM	Nitrile	EPDM	Non-Valve FKM	Non-Valve Nitrile	Non-Valve EPDM	
-4	22104	22104B	22104F	22104A	22104C	22104AF	
-6	22106	22106B	22106F	22106A	22106C	22106AF	
Male O-Ring Boss Seal (ORB) 45°							
Size	FKM	Nitrile	EPDM	Non-Valve FKM	Non-Valve Nitrile	Non-Valve EPDM	
-4	22104D	22104BD	22104FD	22104AD	22104CD	22104AFD	
-6	22106D	22106BD	22106FD	22106AD	22106CD	22106AFD	
Male O-Ring Boss Seal (ORB) 90°							
Size	FKM	Nitrile	EPDM	Non-Valve FKM	Non-Valve Nitrile	Non-Valve EPDM	
-4	22104E	22104BE	22104FE	22104AE	22104CE	22104AFE	
-6	22106E	22106BE	22106FE	22106AE	22106CE	22106AFE	
FEMALE 37° AN Straight							
Size	FKM	Nitrile	EPDM	Non-Valve FKM	Non-Valve Nitrile	Non-Valve EPDM	
-4 AN	22304	22304B	22304F	22304A	22304C	22304AF	
-6 AN	22306	22306B	22306F	22306A	22306C	22306AF	
FEMALE 37° AN 45 Degree - Swivel							
Size	FKM	Nitrile	EPDM	Non-Valve FKM	Non-Valve Nitrile	Non-Valve EPDM	
-4 AN	22304D	22304BD	22304FD	22304AD	22304CD	22304AFD	
-6 AN	22306D	22306BD	22306FD	22306AD	22306CD	22306AFD	
FEMALE 37° AN 90 Degree - Swivel							
Size	FKM	Nitrile	EPDM	Non-Valve FKM	Non-Valve Nitrile	Non-Valve EPDM	
-4 AN	22304E	22304BE	22304FE	22304AE	22304CE	22304AFE	
-6 AN	22306E	22306BE	22306FE	22306AE	22306CE	22306AFE	
MALE 37° AN Straight							
Size	FKM	Nitrile	EPDM	Non-Valve FKM	Non-Valve Nitrile	Non-Valve EPDM	
-3 AN	22403	22403B	22403F	22403A	22403C	22403AF	
-4 AN	22404	22404B	22404F	22404A	22404C	22404AF	
-6 AN	22406	22406B	22406F	22406A	22406C	22406AF	
MALE 37° AN 45 Degree							
Size	FKM	Nitrile	EPDM	Non-Valve FKM	Non-Valve Nitrile	Non-Valve EPDM	
-3 AN	22403D	22403BD	22403FD	22403AD	22403CD	22403AFD	
-4 AN	22404D	22404BD	22404FD	22404AD	22404CD	22404AFD	
-6 AN	22406D	22406BD	22406FD	22406AD	22406CD	22406AFD	
MALE 37° AN 90 Degree							
Size	FKM	Nitrile	EPDM	Non-Valve FKM	Non-Valve Nitrile	Non-Valve EPDM	
-3 AN	22403E	22403BE	22403FE	22403AE	22403CE	22403AFE	
-4 AN	22404E	22404BE	22404FE	22404AE	22404CE	22404AFE	
-6 AN	22406E	22406BE	22406FE	22406AE	22406CE	22406AFE	

PLUGS

Hose Barb Straight						
Size	FKM	Nitrile	EPDM	Non-Valve FKM	Non-Valve Nitrile	Non-Valve EPDM
-3 AN	22503	22503B	22503F	22503A	22503C	22503AF
-4 AN	22504	22504B	22504F	22504A	22504C	22504AF
-5 AN	22505	22505B	22505F	22505A	22505C	22505AF
-6 AN	22506	22506B	22506F	22506A	22506C	22506AF
Hose Barb 45°						
Size	FKM	Nitrile	EPDM	Non-Valve FKM	Non-Valve Nitrile	Non-Valve EPDM
-3 AN	22503D	22503BD	22503FD	22503AD	22503CD	22503AFD
-4 AN	22504D	22504BD	22504FD	22504AD	22504CD	22504AFD
-5 AN	22505D	22505BD	22505FD	22505AD	22505CD	22505AFD
-6 AN	22506D	22506BD	22506FD	22506AD	22506CD	22506AFD
Hose Barb 90°						
Size	FKM	Nitrile	EPDM	Non-Valve FKM	Non-Valve Nitrile	Non-Valve EPDM
-3 AN	22503E	22503BE	22503FE	22503AE	22503CE	22503AFE
-4 AN	22504E	22504BE	22504FE	22504AE	22504CE	22504AFE
-5 AN	22505E	22505BE	22505FE	22505AE	22505CE	22505AFE
-6 AN	22506E	22506BE	22506FE	22506AE	22506CE	22506AFE
Push To Lock Hose Barb Straight						
Size	FKM	Nitrile	EPDM	Non-Valve FKM	Non-Valve Nitrile	Non-Valve EPDM
-4	22504P	22504BP	22504FP	22504AP	22504CP	22504AFP
-6	22506P	22506BP	22506FP	22506AP	22506CP	22506AFP
Push To Lock Hose Barb 45°						
Size	FKM	Nitrile	EPDM	Non-Valve FKM	Non-Valve Nitrile	Non-Valve EPDM
-4	22504PD	22504BPD	22504FPD	22504APD	22504CPD	22504AFPD
-6	22506PD	22506BPD	22506FPD	22506APD	22506CPD	22506AFPD
Push To Lock Hose Barb 90°						
Size	FKM	Nitrile	EPDM	Non-Valve FKM	Non-Valve Nitrile	Non-Valve EPDM
-4	22504PE	22504BPE	22504FPE	22504APE	22504CPE	22504AFPE
-6	22506PE	22506BPE	22506FPE	22506APE	22506CPE	22506AFPE
Reusable Nut Hose End Straight - Gold						
Size	FKM	Nitrile	EPDM	Non-Valve FKM	Non-Valve Nitrile	Non-Valve EPDM
-4 AN	22604	22604B	22604F	22604A	22604C	22604AF
-6 AN	22606	22606B	22606F	22606A	22606C	22606AF
Reusable Nut Hose End 45° - Gold						
Size	FKM	Nitrile	EPDM	Non-Valve FKM	Non-Valve Nitrile	Non-Valve EPDM
-4 AN	22604D	22604BD	22604FD	22604AD	22604CD	22604AFD
-6 AN	22606D	22606BD	22606FD	22606AD	22606CD	22606AFD
Reusable Nut Hose End 90° - Gold						
Size	FKM	Nitrile	EPDM	Non-Valve FKM	Non-Valve Nitrile	Non-Valve EPDM
-4 AN	22604E	22604BE	22604FE	22604AE	22604CE	22604AFE
-6 AN	22606E	22606BE	22606FE	22606AE	22606CE	22606AFE



PLUGS

Reusable Nut Hose End Straight - Black							
Size	FKM	Nitrile	EPDM	Non-Valve FKM	Non-Valve Nitrile	Non-Valve EPDM	
-4 AN	22604J	22604BJ	22604FJ	22604AJ	22604CJ	22604AFJ	
-6 AN	22606J	22606BJ	22606FJ	22606AJ	22606CJ	22606AFJ	
Reusable Nut Hose End 45° - Black							
Size	FKM	Nitrile	EPDM	Non-Valve FKM	Non-Valve Nitrile	Non-Valve EPDM	
-4 AN	22604JD	22604BJD	22604FDJ	22604AFJD	22604CJD	22604AFJD	
-6 AN	22606JD	22606BJD	22606FDJ	22606AJD	22606CJD	22606AFJD	
Reusable Nut Hose End 90° - Black							
Size	FKM	Nitrile	EPDM	Non-Valve FKM	Non-Valve Nitrile	Non-Valve EPDM	
-4 AN	22604JE	22604BJE	22604FJE	22604AJE	22604CJE	22604AFJE	
-6 AN	22606JE	22606BJE	22606FJE	22606AJE	22606CJE	22606AFJE	
Female NPT Straight							
Size	FKM	Nitrile	EPDM	Non-Valve FKM	Non-Valve Nitrile	Non-Valve EPDM	
1/8"	22702	22702B	22702F	22702A	22702C	22702AF	
1/4"	22704	22704B	22704F	22704A	22704C	22704AF	
Female NPT 45°							
Size	FKM	Nitrile	EPDM	Non-Valve FKM	Non-Valve Nitrile	Non-Valve EPDM	
1/8"	22702D	22702BD	22702FD	22702AD	22702CD	22702AFD	
1/4"	22704D	22704BD	22704FD	22704AD	22704CD	22704AFD	
Female NPT 90°							
Size	FKM	Nitrile	EPDM	Non-Valve FKM	Non-Valve Nitrile	Non-Valve EPDM	
1/8"	22702E	22702BE	22702FE	22702AE	22702CE	22702AFE	
1/4"	22704E	22704BE	22704FE	22704AE	22704CE	22704AFE	
Male NPT Straight							
Size	FKM	Nitrile	EPDM	Non-Valve FKM	Non-Valve Nitrile	Non-Valve EPDM	
1/8"	22802	22802B	22802F	22802A	22802C	22802AF	
1/4"	22804	22804B	22804F	22804A	22804C	22804AF	
Male NPT 45°							
Size	FKM	Nitrile	EPDM	Non-Valve FKM	Non-Valve Nitrile	Non-Valve EPDM	
1/8"	22802D	22802BD	22802FD	22802AD	22802CD	22802AFD	
1/4"	22804D	22804BD	22804FD	22804AD	22804CD	22804AFD	
Male NPT 90°							
Size	FKM	Nitrile	EPDM	Non-Valve FKM	Non-Valve Nitrile	Non-Valve EPDM	
1/8"	22802E	22802BE	22802FE	22802AE	22802CE	22802AFE	
1/4"	22804E	22804BE	22804FE	22804AE	22804CE	22804AFE	



3000

3000 Series are available in the following sizes:

- -6 AN to -8 AN 37° Male and Female
- 1/4" to 3/8" Male and Female NPT
- -6 AN to -8 AN Hose Barb
- -6 to -8 Push to Lock Hose Barb
- -6 AN to -8 AN Reusable Nut Hose End
- -6 to -8 Male O-ring Boss Seal
- -6 AN to -8 AN Lanyard Reusable Nut Hose End and Lanyard 37° Male AN

All 3000 series are available in straight, 45° and 90°.

All fittings are also available non-valved to allow for a 100% flow through application.

Caps, plugs, and C clips are also available.

All sockets and plugs in the same series are interchangeable.

Flow Information

Jiffy-tite Quick-Connect Fluid Fittings using standard stoddard solvent with a specific gravity of .750 and 80° fluid temperature through a -8AN hose.

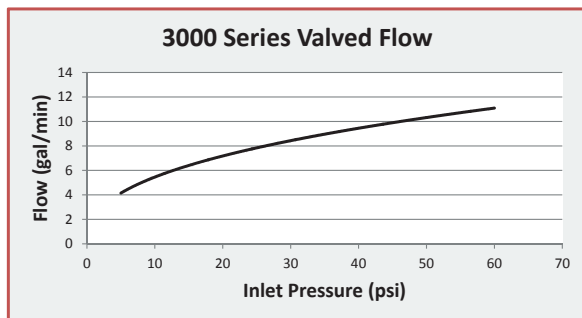

DIMENSIONS

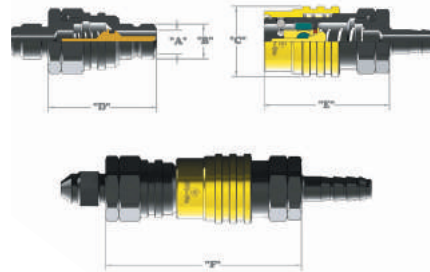

STRAIGHT 3000 SERIES

A	B	C	D	E	F
.37	.53	1.03	1.45	1.78	2.63

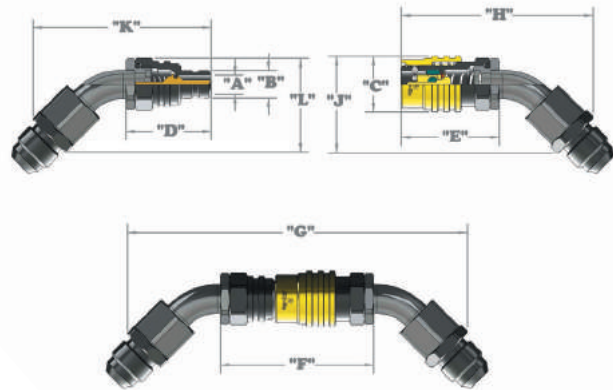

45° 3000 SERIES

A	B	C	D	E	F	G	H	J	K	L
.37	.53	1.03	1.56	1.91	2.86	5.80	3.39	1.58	2.41	1.56

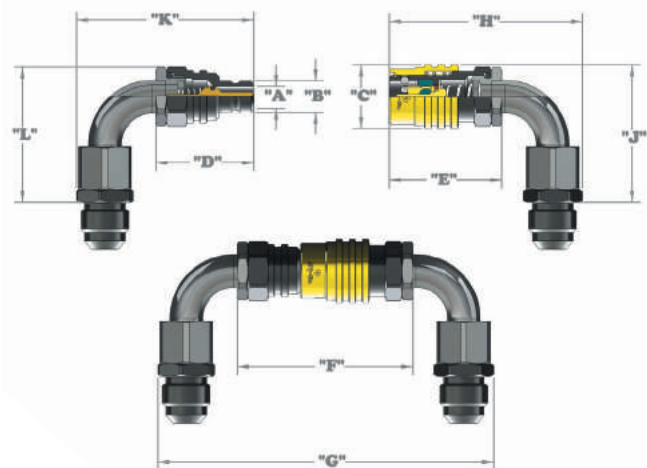

90° 3000 SERIES

A	B	C	D	E	F	G	H	J	K	L
.37	.53	1.03	1.56	1.91	2.86	5.43	3.21	2.11	2.83	2.10

SOCKETS

Male O-Ring Boss Seal (ORB) Straight - Gold

Size	FKM	Nitrile	EPDM	Non-Valve FKM	Non-Valve Nitrile	Non-Valve EPDM
-6	31106	31106B	31106F	31106A	31106C	31106AF
-8	31108	31108B	31108F	31108A	31108C	31108AF



Male O-Ring Boss Seal (ORB) 45° - Gold

Size	FKM	Nitrile	EPDM	Non-Valve FKM	Non-Valve Nitrile	Non-Valve EPDM
-6	31106D	31106BD	31106FD	31106AD	31106CD	31106AFD
-8	31108D	31108BD	31108FD	31108AD	31108CD	31108AFD



Male O-Ring Boss Seal (ORB) 90° - Gold

Size	FKM	Nitrile	EPDM	Non-Valve FKM	Non-Valve Nitrile	Non-Valve EPDM
-6	31106E	31106BE	31106FE	31106AE	31106CE	31106AFE
-8	31108E	31108BE	31108FE	31108AE	31108CE	31108AFE



Male O-Ring Boss Seal (ORB) Straight - Black

Size	FKM	Nitrile	EPDM	Non-Valve FKM	Non-Valve Nitrile	Non-Valve EPDM
-6	31106J	31106BJ	31106FJ	31106AJ	31106CJ	31106AFJ
-8	31108J	31108BJ	31108FJ	31108AJ	31108CJ	31108AFJ



Male O-Ring Boss Seal (ORB) 45° - Black

Size	FKM	Nitrile	EPDM	Non-Valve FKM	Non-Valve Nitrile	Non-Valve EPDM
-6	31106JD	31106BJD	31106FJD	31106AJD	31106CJD	31106AFJD
-8	31108JD	31108BJD	31108FJD	31108AJD	31108CJD	31108AFJD



Male O-Ring Boss Seal (ORB) 90° - Black

Size	FKM	Nitrile	EPDM	Non-Valve FKM	Non-Valve Nitrile	Non-Valve EPDM
-6	31106JE	31106BJE	31106FJE	31106AJE	31106CJE	31106AFJE
-8	31108JE	31108BJE	31108FJE	31108AJE	31108CJE	31108AFJE



FEMALE 37° AN Straight - Gold

Size	FKM	Nitrile	EPDM	Non-Valve FKM	Non-Valve Nitrile	Non-Valve EPDM
-6 AN	31306	31306B	31306F	31306A	31306C	31306AF
-8 AN	31308	31308B	31308F	31308A	31308C	31308AF



FEMALE 37° AN 45 Degree - Gold - Swivel

Size	FKM	Nitrile	EPDM	Non-Valve FKM	Non-Valve Nitrile	Non-Valve EPDM
-6 AN	31306D	31306BD	31306FD	31306AD	31306CD	31306AFD
-8 AN	31308D	31308BD	31308FD	31308AD	31308CD	31308AFD



FEMALE 37° AN 90 Degree - Gold - Swivel

Size	FKM	Nitrile	EPDM	Non-Valve FKM	Non-Valve Nitrile	Non-Valve EPDM
-6 AN	31306E	31306BE	31306FE	31306AE	31306CE	31306AFE
-8 AN	31308E	31308BE	31308FE	31308AE	31308CE	31308AFE



FEMALE 37° AN Straight - Black

Size	FKM	Nitrile	EPDM	Non-Valve FKM	Non-Valve Nitrile	Non-Valve EPDM
-6 AN	31306J	31306BJ	31306FJ	31306AJ	31306CJ	31306AFJ
-8 AN	31308J	31308BJ	31308FJ	31308AJ	31308CJ	31308AFJ



FEMALE 37° AN 45 Degree - Black - Swivel

Size	FKM	Nitrile	EPDM	Non-Valve FKM	Non-Valve Nitrile	Non-Valve EPDM
-6 AN	31306JD	31306BJD	31306FJD	31306AJD	31306CJD	31306AFJD
-8 AN	31308JD	31308BJD	31308FJD	31308AJD	31308CJD	31308AFJD



SOCKETS

FEMALE 37° AN 90 Degree - Black - Swivel							
Size	FKM	Nitrile	EPDM	Non-Valve FKM	Non-Valve Nitrile	Non-Valve EPDM	
-6 AN	31306JE	31306BJE	31306FJE	31306AJE	31306CJE	31306AFJE	
-8 AN	31308JE	31308BJE	31308FJE	31308AJE	31308CJE	31308AFJE	
MALE 37° AN Straight - Gold							
Size	FKM	Nitrile	EPDM	Non-Valve FKM	Non-Valve Nitrile	Non-Valve EPDM	
-6 AN	31406	31406B	31406F	31406A	31406C	31406AF	
-8 AN	31408	31408B	31408F	31408A	31408C	31408AF	
MALE 37° AN 45 Degree - Gold							
Size	FKM	Nitrile	EPDM	Non-Valve FKM	Non-Valve Nitrile	Non-Valve EPDM	
-6 AN	31406D	31406BD	31406FD	31406AD	31406CD	31406AFD	
-8 AN	31408D	31408BD	31408FD	31408AD	31408CD	31408AFD	
MALE 37° AN 90 Degree - Gold							
Size	FKM	Nitrile	EPDM	Non-Valve FKM	Non-Valve Nitrile	Non-Valve EPDM	
-6 AN	31406E	31406BE	31406FE	31406AE	31406CE	31406AFE	
-8 AN	31408E	31408BE	31408FE	31408AE	31408CE	31408AFE	
Lanyard 37° AN Male - Gold							
Size	FKM	Nitrile	EPDM	Non-Valve FKM	Non-Valve Nitrile	Non-Valve EPDM	
-6 AN	31406M	31406BM	31406FM	31406AM	31406CM	31406AFM	
-8 AN	31408M	31408BM	31408FM	31408AM	31408CM	31408AFM	
MALE 37° AN Straight - Black							
Size	FKM	Nitrile	EPDM	Non-Valve FKM	Non-Valve Nitrile	Non-Valve EPDM	
-6 AN	31406J	31406BJ	31406FJ	31406AJ	31406CJ	31406AFJ	
-8 AN	31408J	31408BJ	31408FJ	31408AJ	31408CJ	31408AFJ	
MALE 37° AN 45 Degree - Black							
Size	FKM	Nitrile	EPDM	Non-Valve FKM	Non-Valve Nitrile	Non-Valve EPDM	
-6 AN	31406JD	31406BJD	31406FJD	31406AJD	31406CJD	31406AFJD	
-8 AN	31408JD	31408BJD	31408FJD	31408AJD	31408CJD	31408AFJD	
MALE 37° AN 90 Degree - Black							
Size	FKM	Nitrile	EPDM	Non-Valve FKM	Non-Valve Nitrile	Non-Valve EPDM	
-6 AN	31406JE	31406BJE	31406FJE	31406AJE	31406CJE	31406AFJE	
-8 AN	31408JE	31408BJE	31408FJE	31408AJE	31408CJE	31408AFJE	
Lanyard 37° AN Male - Black							
Size	FKM	Nitrile	EPDM	Non-Valve FKM	Non-Valve Nitrile	Non-Valve EPDM	
-6 AN	31406MJ	31406BMJ	31406FMJ	31406AMJ	31406CMJ	31406AFMJ	
-8 AN	31408MJ	31408BMJ	31408FMJ	31408AMJ	31408CMJ	31408AFMJ	
Hose Barb Straight - Gold							
Size	FKM	Nitrile	EPDM	Non-Valve FKM	Non-Valve Nitrile	Non-Valve EPDM	
-6 AN	31506	31506B	31506F	31506A	31506C	31506AF	
-8 AN	31508	31508B	31508F	31508A	31508C	31508AF	
Hose Barb 45° - Gold							
Size	FKM	Nitrile	EPDM	Non-Valve FKM	Non-Valve Nitrile	Non-Valve EPDM	
-6 AN	31506D	31506BD	31506FD	31506AD	31506CD	31506AFD	
-8 AN	31508D	31508BD	31508FD	31508AD	31508CD	31508AFD	

SOCKETS

Hose Barb 90° - Gold							
Size	FKM	Nitrile	EPDM	Non-Valve FKM	Non-Valve Nitrile	Non-Valve EPDM	
-6 AN	31506E	31506BE	31506FE	31506AE	31506CE	31506AFE	
-8 AN	31508E	31508BE	31508FE	31508AE	31508CE	31508AFE	
Hose Barb Straight - Black							
Size	FKM	Nitrile	EPDM	Non-Valve FKM	Non-Valve Nitrile	Non-Valve EPDM	
-6 AN	31506J	31506BJ	31506FJ	31506AJ	31506CJ	31506AFJ	
-8 AN	31508J	31508BJ	31508FJ	31508AJ	31508CJ	31508AFJ	
Hose Barb 45° - Black							
Size	FKM	Nitrile	EPDM	Non-Valve FKM	Non-Valve Nitrile	Non-Valve EPDM	
-6 AN	31506JD	31506BJD	31506FJD	31506AJD	31506CJD	31506AFJD	
-8 AN	31508JD	31508BJD	31508FJD	31508AJD	31508CJD	31508AFJD	
Hose Barb 90° - Black							
Size	FKM	Nitrile	EPDM	Non-Valve FKM	Non-Valve Nitrile	Non-Valve EPDM	
-6 AN	31506JE	31506BJE	31506FJE	31506AJE	31506CJE	31506AFJE	
-8 AN	31508JE	31508BJE	31508FJE	31508AJE	31508CJE	31508AFJE	
Push To Lock Hose Barb Straight - Gold							
Size	FKM	Nitrile	EPDM	Non-Valve FKM	Non-Valve Nitrile	Non-Valve EPDM	
-6	31506P	31506BP	31506FP	31506AP	31506CP	31506AFP	
-8	31508P	31508BP	31508FP	31508AP	31508CP	31508AFP	
Push To Lock Hose Barb 45° - Gold							
Size	FKM	Nitrile	EPDM	Non-Valve FKM	Non-Valve Nitrile	Non-Valve EPDM	
-6	31506PD	31506BPD	31506FPD	31506APD	31506CPD	31506AFPD	
-8	31508PD	31508BPD	31508FPD	31508APD	31508CPD	31508AFPD	
Push To Lock Hose Barb 90° - Gold							
Size	FKM	Nitrile	EPDM	Non-Valve FKM	Non-Valve Nitrile	Non-Valve EPDM	
-6	31506PE	31506BPE	31506FPE	31506APE	31506CPE	31506AFPE	
-8	31508PE	31508BPE	31508FPE	31508APE	31508CPE	31508AFPE	
Push To Lock Hose Barb Straight - Black							
Size	FKM	Nitrile	EPDM	Non-Valve FKM	Non-Valve Nitrile	Non-Valve EPDM	
-6	31506PJ	31506BPJ	31506FPJ	31506APJ	31506CPJ	31506AFPJ	
-8	31508PJ	31508BPJ	31508FPJ	31508APJ	31508CPJ	31508AFPJ	
Push To Lock Hose Barb 45° - Black							
Size	FKM	Nitrile	EPDM	Non-Valve FKM	Non-Valve Nitrile	Non-Valve EPDM	
-6	31506PJD	31506BPJD	31506FPJD	31506APJD	31506CPJD	31506AFPJD	
-8	31508PJD	31508BPJD	31508FPJD	31508APJD	31508CPJD	31508AFPJD	
Push To Lock Hose Barb 90° - Black							
Size	FKM	Nitrile	EPDM	Non-Valve FKM	Non-Valve Nitrile	Non-Valve EPDM	
-6	31506PJE	31506BPJE	31506FPJE	31506APJE	31506CPJE	31506AFPJE	
-8	31508PJE	31508BPJE	31508FPJE	31508APJE	31508CPJE	31508AFPJE	
Reusable Nut Hose End Straight - Gold							
Size	FKM	Nitrile	EPDM	Non-Valve FKM	Non-Valve Nitrile	Non-Valve EPDM	
-6 AN	31606	31606B	31606F	31606A	31606C	31606AF	
-8 AN	31608	31608B	31608F	31608A	31608C	31608AF	

SOCKETS











Reusable Nut Hose End 45° - Gold							
Size	FKM	Nitrile	EPDM	Non-Valve FKM	Non-Valve Nitrile	Non-Valve EPDM	
-6 AN	31606D	31606BD	31606FD	31606AD	31606CD	31606AFD	
-8 AN	31608D	31608BD	31608FD	31608AD	31608CD	31608AFD	
Reusable Nut Hose End 90° - Gold							
Size	FKM	Nitrile	EPDM	Non-Valve FKM	Non-Valve Nitrile	Non-Valve EPDM	
-6 AN	31606E	31606BE	31606FE	31606AE	31606CE	31606AFE	
-8 AN	31608E	31608BE	31608FE	31608AE	31608CE	31608AFE	
Reusable Nut Hose End Straight - Black							
Size	FKM	Nitrile	EPDM	Non-Valve FKM	Non-Valve Nitrile	Non-Valve EPDM	
-6 AN	31606J	31606BJ	31606FJ	31606AJ	31606CJ	31606AFJ	
-8 AN	31608J	31608BJ	31608FJ	31608AJ	31608CJ	31608AFJ	
Reusable Nut Hose End 45° - Black							
Size	FKM	Nitrile	EPDM	Non-Valve FKM	Non-Valve Nitrile	Non-Valve EPDM	
-6 AN	31606JD	31606BJD	31606FDJ	31606AFJD	31606CJD	31606AFJD	
-8 AN	31608JD	31608BJD	31608FDJ	31608AJD	31608CJD	31608AFJD	
Reusable Nut Hose End 90° - Black							
Size	FKM	Nitrile	EPDM	Non-Valve FKM	Non-Valve Nitrile	Non-Valve EPDM	
-6 AN	31606JE	31606BJE	31606FJE	31606AJE	31606CJE	31606AFJE	
-8 AN	31608JE	31608BJE	31608FJE	31608AJE	31608CJE	31608AFJE	
Lanyard Reusable Nut Hose End - Gold							
Size	FKM	Nitrile	EPDM	Non-Valve FKM	Non-Valve Nitrile	Non-Valve EPDM	
-6 AN	31606M	31606BM	31606FM	31606AM	31606CM	31606AFM	
-8 AN	31608M	31608BM	31608FM	31608AM	31608CM	31608AFM	
Lanyard Reusable Nut Hose End - Black							
Size	FKM	Nitrile	EPDM	Non-Valve FKM	Non-Valve Nitrile	Non-Valve EPDM	
-6 AN	31606MJ	31606BMJ	31606FMJ	31606AMJ	31606CMJ	31606AFMJ	
-8 AN	31608MJ	31608BMJ	31608FMJ	31608AMJ	31608CMJ	31608AFMJ	
Female NPT Straight - Gold							
Size	FKM	Nitrile	EPDM	Non-Valve FKM	Non-Valve Nitrile	Non-Valve EPDM	
1/4"	31704	31704B	31704F	31704A	31704C	31704AF	
3/8"	31706	31706B	31706F	31706A	31706C	31706AF	
Female NPT 45° - Gold							
Size	FKM	Nitrile	EPDM	Non-Valve FKM	Non-Valve Nitrile	Non-Valve EPDM	
1/4"	31704D	31704BD	31704FD	31704AD	31704CD	31704AFD	
3/8"	31706D	31706BD	31706FD	31706AD	31706CD	31706AFD	
Female NPT 90° - Gold							
Size	FKM	Nitrile	EPDM	Non-Valve FKM	Non-Valve Nitrile	Non-Valve EPDM	
1/4"	31704E	31704BE	31704FE	31704AE	31704CE	31704AFE	
3/8"	31706E	31706BE	31706FE	31706AE	31706CE	31706AFE	
Female NPT Straight - Black							
Size	FKM	Nitrile	EPDM	Non-Valve FKM	Non-Valve Nitrile	Non-Valve EPDM	
1/4"	31704J	31704BJ	31704FJ	31704AJ	31704CJ	31704AFJ	
3/8"	31706J	31706BJ	31706FJ	31706AJ	31706CJ	31706AFJ	

SOCKETS











Female NPT 45° - Black							
Size	FKM	Nitrile	EPDM	Non-Valve FKM	Non-Valve Nitrile	Non-Valve EPDM	
1/4"	31704JD	31704BJD	31704FJD	31704AJD	31704CJD	31704AFJD	
3/8"	31706JD	31706BJD	31706FJD	31706AJD	31706CJD	31706AFJD	
Female NPT 90° - Black							
Size	FKM	Nitrile	EPDM	Non-Valve FKM	Non-Valve Nitrile	Non-Valve EPDM	
1/4"	31704JE	31704BJE	31704FJE	31704AJE	31704CJE	31704AFJE	
3/8"	31706JE	31706BJE	31706FJE	31706AJE	31706CJE	31706AFJE	
Male NPT Straight - Gold							
Size	FKM	Nitrile	EPDM	Non-Valve FKM	Non-Valve Nitrile	Non-Valve EPDM	
1/4"	31804	31804B	31804F	31804A	31804C	31804AF	
3/8"	31806	31806B	31806F	31806A	31806C	31806AF	
Male NPT 45° - Gold							
Size	FKM	Nitrile	EPDM	Non-Valve FKM	Non-Valve Nitrile	Non-Valve EPDM	
1/4"	31804D	31804BD	31804FD	31804AD	31804CD	31804AFD	
3/8"	31806D	31806BD	31806FD	31806AD	31806CD	31806AFD	
Male NPT 90° - Gold							
Size	FKM	Nitrile	EPDM	Non-Valve FKM	Non-Valve Nitrile	Non-Valve EPDM	
1/4"	31804E	31804BE	31804FE	31804AE	31804CE	31804AFE	
3/8"	31806E	31806BE	31806FE	31806AE	31806CE	31806AFE	
Male NPT Straight - Black							
Size	FKM	Nitrile	EPDM	Non-Valve FKM	Non-Valve Nitrile	Non-Valve EPDM	
1/4"	31804J	31804BJ	31804FJ	31804AJ	31804CJ	31804AFJ	
3/8"	31806J	31806BJ	31806FJ	31806AJ	31806CJ	31806AFJ	
Male NPT 45° - Black							
Size	FKM	Nitrile	EPDM	Non-Valve FKM	Non-Valve Nitrile	Non-Valve EPDM	
1/4"	31804JD	31804BJD	31804FJD	31804AJD	31804CJD	31804AFJD	
3/8"	31806JD	31806BJD	31806FJD	31806AJD	31806CJD	31806AFJD	
Male NPT 90° - Black							
Size	FKM	Nitrile	EPDM	Non-Valve FKM	Non-Valve Nitrile	Non-Valve EPDM	
1/4"	31804JE	31804BJE	31804FJE	31804AJE	31804CJE	31804AFJE	
3/8"	31806JE	31806BJE	31806FJE	31806AJE	31806CJE	31806AFJE	
3000 Series Socket Cap				3000 Series Plug Cap			
MS3000P	Fits Any 3000 Series Socket			MS3000C	Fits Any 3000 Series Plug		
							







PLUGS

Male O-Ring Boss Seal (ORB) Straight							
Size	FKM	Nitrile	EPDM	Non-Valve FKM	Non-Valve Nitrile	Non-Valve EPDM	
-6	32106	32106B	32106F	32106A	32106C	32106AF	
-8	32108	32108B	32108F	32108A	32108C	32108AF	
Male O-Ring Boss Seal (ORB) 45°							
Size	FKM	Nitrile	EPDM	Non-Valve FKM	Non-Valve Nitrile	Non-Valve EPDM	
-6	32106D	32106BD	32106FD	32106AD	32106CD	32106AFD	
-8	32108D	32108BD	32108FD	32108AD	32108CD	32108AFD	
Male O-Ring Boss Seal (ORB) 90°							
Size	FKM	Nitrile	EPDM	Non-Valve FKM	Non-Valve Nitrile	Non-Valve EPDM	
-6	32106E	32106BE	32106FE	32106AE	32106CE	32106AFE	
-8	32108E	32108BE	32108FE	32108AE	32108CE	32108AFE	
FEMALE 37° AN Straight							
Size	FKM	Nitrile	EPDM	Non-Valve FKM	Non-Valve Nitrile	Non-Valve EPDM	
-6 AN	32306	32306B	32306F	32306A	32306C	32306AF	
-8 AN	32308	32308B	32308F	32308A	32308C	32308AF	
FEMALE 37° AN 45 Degree - Swivel							
Size	FKM	Nitrile	EPDM	Non-Valve FKM	Non-Valve Nitrile	Non-Valve EPDM	
-6 AN	32306D	32306BD	32306FD	32306AD	32306CD	32306AFD	
-8 AN	32308D	32308BD	32308FD	32308AD	32308CD	32308AFD	
FEMALE 37° AN 90 Degree - Swivel							
Size	FKM	Nitrile	EPDM	Non-Valve FKM	Non-Valve Nitrile	Non-Valve EPDM	
-6 AN	32306E	32306BE	32306FE	32306AE	32306CE	32306AFE	
-8 AN	32308E	32308BE	32308FE	32308AE	32308CE	32308AFE	
MALE 37° AN Straight							
Size	FKM	Nitrile	EPDM	Non-Valve FKM	Non-Valve Nitrile	Non-Valve EPDM	
-6 AN	32406	32406B	32406F	32406A	32406C	32406AF	
-8 AN	32408	32408B	32408F	32408A	32408C	32408AF	
MALE 37° AN 45 Degree							
Size	FKM	Nitrile	EPDM	Non-Valve FKM	Non-Valve Nitrile	Non-Valve EPDM	
-6 AN	32406D	32406BD	32406FD	32406AD	32406CD	32406AFD	
-8 AN	32408D	32408BD	32408FD	32408AD	32408CD	32408AFD	
MALE 37° AN 90 Degree							
Size	FKM	Nitrile	EPDM	Non-Valve FKM	Non-Valve Nitrile	Non-Valve EPDM	
-6 AN	32406E	32406BE	32406FE	32406AE	32406CE	32406AFE	
-8 AN	32408E	32408BE	32408FE	32408AE	32408CE	32408AFE	
Hose Barb Straight							
Size	FKM	Nitrile	EPDM	Non-Valve FKM	Non-Valve Nitrile	Non-Valve EPDM	
-6 AN	32506	32506B	32506F	32506A	32506C	32506AF	
-8 AN	32508	32508B	32508F	32508A	32508C	32508AF	
Hose Barb 45°							
Size	FKM	Nitrile	EPDM	Non-Valve FKM	Non-Valve Nitrile	Non-Valve EPDM	
-6 AN	32506D	32506BD	32506FD	32506AD	32506CD	32506AFD	
-8 AN	32508D	32508BD	32508FD	32508AD	32508CD	32508AFD	

PLUGS

Hose Barb 90°							
Size	FKM	Nitrile	EPDM	Non-Valve FKM	Non-Valve Nitrile	Non-Valve EPDM	
-6 AN	32506E	32506BE	32506FE	32506AE	32506CE	32506AFE	
-8 AN	32508E	32508BE	32508FE	32508AE	32508CE	32508AFE	
Push To Lock Hose Barb Straight							
Size	FKM	Nitrile	EPDM	Non-Valve FKM	Non-Valve Nitrile	Non-Valve EPDM	
-6	32506P	32506BP	32506FP	32506AP	32506CP	32506AFP	
-8	32508P	32508BP	32508FP	32508AP	32508CP	32508AFP	
Push To Lock Hose Barb 45°							
Size	FKM	Nitrile	EPDM	Non-Valve FKM	Non-Valve Nitrile	Non-Valve EPDM	
-6	32506PD	32506BPD	32506FPD	32506APD	32506CPD	32506AFPD	
-8	32508PD	32508BPD	32508FPD	32508APD	32508CPD	32508AFPD	
Push To Lock Hose Barb 90°							
Size	FKM	Nitrile	EPDM	Non-Valve FKM	Non-Valve Nitrile	Non-Valve EPDM	
-6	32506PE	32506BPE	32506FPE	32506APE	32506CPE	32506AFPE	
-8	32508PE	32508BPE	32508FPE	32508APE	32508CPE	32508AFPE	
Reusable Nut Hose End Straight - Gold							
Size	FKM	Nitrile	EPDM	Non-Valve FKM	Non-Valve Nitrile	Non-Valve EPDM	
-6 AN	32606	32606B	32606F	32606A	32606C	32606AF	
-8 AN	32608	32608B	32608F	32608A	32608C	32608AF	
Reusable Nut Hose End 45° - Gold							
Size	FKM	Nitrile	EPDM	Non-Valve FKM	Non-Valve Nitrile	Non-Valve EPDM	
-6 AN	32606D	32606BD	32606FD	32606AD	32606CD	32606AFD	
-8 AN	32608D	32608BD	32608FD	32608AD	32608CD	32608AFD	
Reusable Nut Hose End 90° - Gold							
Size	FKM	Nitrile	EPDM	Non-Valve FKM	Non-Valve Nitrile	Non-Valve EPDM	
-6 AN	32606E	32606BE	32606FE	32606AE	32606CE	32606AFE	
-8 AN	32608E	32608BE	32608FE	32608AE	32608CE	32608AFE	
Reusable Nut Hose End Straight - Black							
Size	FKM	Nitrile	EPDM	Non-Valve FKM	Non-Valve Nitrile	Non-Valve EPDM	
-6 AN	32606J	32606BJ	32606FJ	32606AJ	32606CJ	32606AFJ	
-8 AN	32608J	32608BJ	32608FJ	32608AJ	32608CJ	32608AFJ	
Reusable Nut Hose End 45° - Black							
Size	FKM	Nitrile	EPDM	Non-Valve FKM	Non-Valve Nitrile	Non-Valve EPDM	
-6 AN	32606JD	32606BJD	32606FDJ	32606AFJD	32606CJD	32606AFJD	
-8 AN	32608JD	32608BJD	32608FDJ	32608AJD	32608CJD	32608AFJD	
Reusable Nut Hose End 90° - Black							
Size	FKM	Nitrile	EPDM	Non-Valve FKM	Non-Valve Nitrile	Non-Valve EPDM	
-6 AN	32606JE	32606BJE	32606FJE	32606AJE	32606CJE	32606AFJE	
-8 AN	32608JE	32608BJE	32608FJE	32608AJE	32608CJE	32608AFJE	
Female NPT Straight							
Size	FKM	Nitrile	EPDM	Non-Valve FKM	Non-Valve Nitrile	Non-Valve EPDM	
1/4"	32704	32704B	32704F	32704A	32704C	32704AF	
3/8"	32706	32706B	32706F	32706A	32706C	32706AF	

PLUGS

Female NPT 45°							
Size	FKM	Nitrile	EPDM	Non-Valve FKM	Non-Valve Nitrile	Non-Valve EPDM	
1/4"	32704D	32704BD	32704FD	32704AD	32704CD	32704AFD	
3/8"	32706D	32706BD	32706FD	32706AD	32706CD	32706AFD	
Female NPT 90°							
Size	FKM	Nitrile	EPDM	Non-Valve FKM	Non-Valve Nitrile	Non-Valve EPDM	
1/4"	32704E	32704BE	32704FE	32704AE	32704CE	32704AFE	
3/8"	32706E	32706BE	32706FE	32706AE	32706CE	32706AFE	
Male NPT Straight							
Size	FKM	Nitrile	EPDM	Non-Valve FKM	Non-Valve Nitrile	Non-Valve EPDM	
1/4"	32804	32804B	32804F	32804A	32804C	32804AF	
3/8"	32806	32806B	32806F	32806A	32806C	32806AF	
Male NPT 45°							
Size	FKM	Nitrile	EPDM	Non-Valve FKM	Non-Valve Nitrile	Non-Valve EPDM	
1/4"	32804D	32804BD	32804FD	32804AD	32804CD	32804AFD	
3/8"	32806D	32806BD	32806FD	32806AD	32806CD	32806AFD	
Male NPT 90°							
Size	FKM	Nitrile	EPDM	Non-Valve FKM	Non-Valve Nitrile	Non-Valve EPDM	
1/4"	32804E	32804BE	32804FE	32804AE	32804CE	32804AFE	
3/8"	32806E	32806BE	32806FE	32806AE	32806CE	32806AFE	



5000

5000 Series are available in the following sizes:

- -8 AN to -12 AN 37° Male and Female
- 3/8" to 3/4" Male and Female NPT
- -8 AN to -12 AN Hose Barb
- -8 to -12 Push to Lock Hose Barb
- -8 AN to -12 AN Reusable Nut Hose End
- -8 to -12 Male O-ring Boss Seal

All 5000 series are available in straight, 45° and 90°.

All fittings are also available non-valved to allow for a 100% flow through application.

Caps, plugs, and C clips are also available.

All sockets and plugs in the same series are interchangeable.

Flow Information

Jiffy-tite Quick-Connect Fluid Fittings using standard stoddard solvent with a specific gravity of .750 and 80° fluid temperature through a -10AN hose.

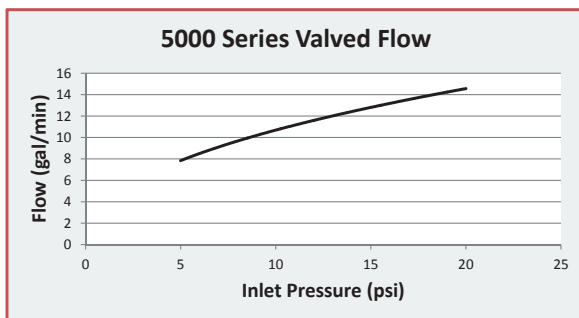

DIMENSIONS

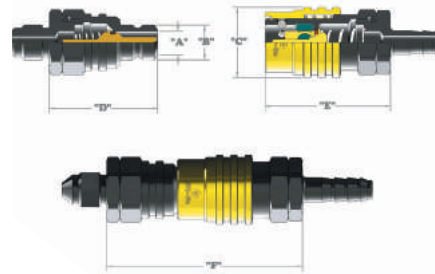

STRAIGHT 5000 SERIES

A	B	C	D	E	F
.59	.78	1.37	1.97	2.34	3.91

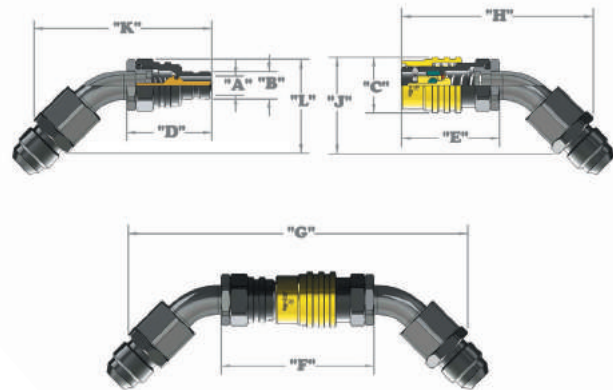

45° 5000 SERIES

A	B	C	D	E	F	G	H	J	K	L
.59	.78	1.37	2.06	2.43	3.71	7.82	4.48	2.21	3.33	2.18

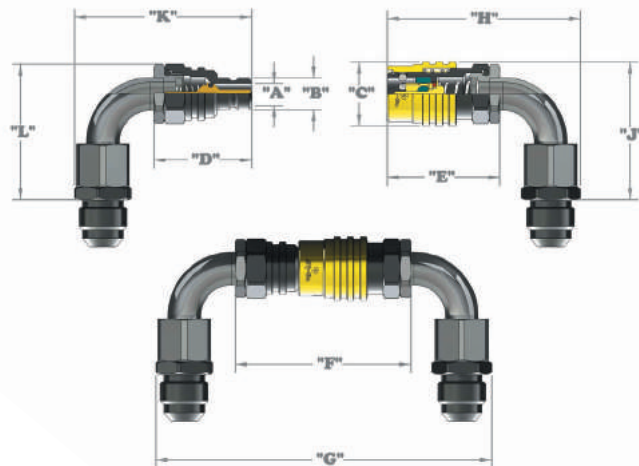

90° 5000 SERIES

A	B	C	D	E	F	G	H	J	K	L
.59	.78	1.37	2.06	2.43	3.71	7.29	4.22	2.94	3.84	2.84

SOCKETS

Male O-Ring Boss Seal (ORB) Straight - Gold						
Size	FKM	Nitrile	EPDM	Non-Valve FKM	Non-Valve Nitrile	Non-Valve EPDM
-8	51108	51108B	51108F	51108A	51108C	51108AF
-10	51110	51110B	51110F	51110A	51110C	51110AF
-12	51112	51112B	51112F	51112A	51112C	51112AF
Male O-Ring Boss Seal (ORB) 45° - Gold						
Size	FKM	Nitrile	EPDM	Non-Valve FKM	Non-Valve Nitrile	Non-Valve EPDM
-8	51108D	51108BD	51108FD	51108AD	51108CD	51108AFD
-10	51110D	51110BD	51110FD	51110AD	51110CD	51110AFD
-12	51112D	51112BD	51112FD	51112AD	51112CD	51112AFD
Male O-Ring Boss Seal (ORB) 90° - Gold						
Size	FKM	Nitrile	EPDM	Non-Valve FKM	Non-Valve Nitrile	Non-Valve EPDM
-8	51108E	51108BE	51108FE	51108AE	51108CE	51108AFE
-10	51110E	51110BE	51110FE	51110AE	51110CE	51110AFE
-12	51112E	51112BE	51112FE	51112AE	51112CE	51112AFE
Male O-Ring Boss Seal (ORB) Straight - Black						
Size	FKM	Nitrile	EPDM	Non-Valve FKM	Non-Valve Nitrile	Non-Valve EPDM
-8	51108J	51108BJ	51108FJ	51108AJ	51108CJ	51108AFJ
-10	51110J	51110BJ	51110FJ	51110AJ	51110CJ	51110AFJ
-12	51112J	51112BJ	51112FJ	51112AJ	51112CJ	51112AFJ
Male O-Ring Boss Seal (ORB) 45° - Black						
Size	FKM	Nitrile	EPDM	Non-Valve FKM	Non-Valve Nitrile	Non-Valve EPDM
-8	51108JD	51108BJD	51108FJD	51108AJD	51108CJD	51108AFJD
-10	51110JD	51110BJD	51110FJD	51110AJD	51110CJD	51110AFJD
-12	51112JD	51112BJD	51112FJD	51112AJD	51112CJD	51112AFJD
Male O-Ring Boss Seal (ORB) 90° - Black						
Size	FKM	Nitrile	EPDM	Non-Valve FKM	Non-Valve Nitrile	Non-Valve EPDM
-8	51108EJ	51108BJE	51108FJE	51108AJE	51108CJE	51108AFJE
-10	51110EJ	51110BJE	51110FJE	51110AJE	51110CJE	51110AFJE
-12	51112EJ	51112BJE	51112FJE	51112AJE	51112CJE	51112AFJE
FEMALE 37° AN Straight - Gold						
Size	FKM	Nitrile	EPDM	Non-Valve FKM	Non-Valve Nitrile	Non-Valve EPDM
-8 AN	51308	51308B	51308F	51308A	51308C	51308AF
-10AN	51310	51310B	51310F	51310A	51310C	51310AF
-12AN	51312	51312B	51312F	51312A	51312C	51312AF
FEMALE 37° AN 45 Degree - Gold - Swivel						
Size	FKM	Nitrile	EPDM	Non-Valve FKM	Non-Valve Nitrile	Non-Valve EPDM
-8 AN	51308D	51308BD	51308FD	51308AD	51308CD	51308AFD
-10AN	51310D	51310BD	51310FD	51310AD	51310CD	51310AFD
-12AN	51312D	51312BD	51312FD	51312AD	51312CD	51312AFD
FEMALE 37° AN 90 Degree - Gold - Swivel						
Size	FKM	Nitrile	EPDM	Non-Valve FKM	Non-Valve Nitrile	Non-Valve EPDM
-8 AN	51308E	51308BE	51308FE	51308AE	51308CE	51308AFE
-10AN	51310E	51310BE	51310FE	51310AE	51310CE	51310AFE
-12AN	51312E	51312BE	51312FE	51312AE	51312CE	51312AFE



SOCKETS

FEMALE 37° AN Straight - Black

Size	FKM	Nitrile	EPDM	Non-Valve FKM	Non-Valve Nitrile	Non-Valve EPDM
-8 AN	51308J	51308BJ	51308FJ	51308AJ	51308CJ	51308AFJ
-10AN	51310J	51310BJ	51310FJ	51310AJ	51310CJ	51310AFJ
-12AN	51312J	51312BJ	51312FJ	51312AJ	51312CJ	51312AFJ



FEMALE 37° AN 45 Degree - Black - Swivel

Size	FKM	Nitrile	EPDM	Non-Valve FKM	Non-Valve Nitrile	Non-Valve EPDM
-8 AN	51308JD	51308BJD	51308FJD	51308AJD	51308CJD	51308AFJD
-10AN	51310JD	51310BJD	51310FJD	51310AJD	51310CJD	51310AFJD
-12AN	51312JD	51312BJD	51312FJD	51312AJD	51312CJD	51312AFJD



FEMALE 37° AN 90 Degree - Black - Swivel

Size	FKM	Nitrile	EPDM	Non-Valve FKM	Non-Valve Nitrile	Non-Valve EPDM
-8 AN	51308JE	51308BJE	51308FJE	51308AJE	51308CJE	51308AFJE
-10AN	51310JE	51310BJE	51310FJE	51310AJE	51310CJE	51310AFJE
-12AN	51312JE	51312BJE	51312FJE	51312AJE	51312CJE	51312AFJE



MALE 37° AN Straight - Gold

Size	FKM	Nitrile	EPDM	Non-Valve FKM	Non-Valve Nitrile	Non-Valve EPDM
-8 AN	51408	51408B	51408F	51408A	51408C	51408AF
-10AN	51410	51410B	51410F	51410A	51410C	51410AF
-12AN	51412	51412B	51412F	51412A	51412C	51412AF



MALE 37° AN 45 Degree - Gold

Size	FKM	Nitrile	EPDM	Non-Valve FKM	Non-Valve Nitrile	Non-Valve EPDM
-8 AN	51408D	51408BD	51408FD	51408AD	51408CD	51408AFD
-10AN	51410D	51410BD	51410FD	51410AD	51410CD	51410AFD
-12AN	51412D	51412BD	51412FD	51412AD	51412CD	51412AFD



MALE 37° AN 90 Degree - Gold

Size	FKM	Nitrile	EPDM	Non-Valve FKM	Non-Valve Nitrile	Non-Valve EPDM
-8 AN	51408E	51408BE	51408FE	51408AE	51408CE	51408AFE
-10AN	51410E	51410BE	51410FE	51410AE	51410CE	51410AFE
-12AN	51412E	51412BE	51412FE	51412AE	51412CE	51412AFE



MALE 37° AN Straight - Black

Size	FKM	Nitrile	EPDM	Non-Valve FKM	Non-Valve Nitrile	Non-Valve EPDM
-8 AN	51408J	51408BJ	51408FJ	51408AJ	51408CJ	51408AFJ
-10AN	51410J	51410BJ	51410FJ	51410AJ	51410CJ	51410AFJ
-12AN	51412J	51412BJ	51412FJ	51412AJ	51412CJ	51412AFJ



MALE 37° AN 45 Degree - Black

Size	FKM	Nitrile	EPDM	Non-Valve FKM	Non-Valve Nitrile	Non-Valve EPDM
-8 AN	51408JD	51408BJD	51408FJD	51408AJD	51408CJD	51408AFJD
-10AN	51410JD	51410BJD	51410FJD	51410AJD	51410CJD	51410AFJD
-12AN	51412JD	51412BJD	51412FJD	51412AJD	51412CJD	51412AFJD



MALE 37° AN 90 Degree - Black

Size	FKM	Nitrile	EPDM	Non-Valve FKM	Non-Valve Nitrile	Non-Valve EPDM
-8 AN	51408JE	51408BJE	51408FJE	51408AJE	51408CJE	51408AFJE
-10AN	51410JE	51410BJE	51410FJE	51410AJE	51410CJE	51410AFJE
-12AN	51412JE	51412BJE	51412FJE	51412AJE	51412CJE	51412AFJE



SOCKETS

Hose Barb Straight - Gold							
Size	FKM	Nitrile	EPDM	Non-Valve FKM	Non-Valve Nitrile	Non-Valve EPDM	
-8 AN	51508	51508B	51508F	51508A	51508C	51508AF	
-10AN	51510	51510B	51510F	51510A	51510C	51510AF	
-12AN	51512	51512B	51512F	51512A	51512C	51512AF	
Hose Barb 45° - Gold							
Size	FKM	Nitrile	EPDM	Non-Valve FKM	Non-Valve Nitrile	Non-Valve EPDM	
-8 AN	51508D	51508BD	51508FD	51508AD	51508CD	51508AFD	
-10AN	51510D	51510BD	51510FD	51510AD	51510CD	51510AFD	
-12AN	51512D	51512BD	51512FD	51512AD	51512CD	51512AFD	
Hose Barb 90° - Gold							
Size	FKM	Nitrile	EPDM	Non-Valve FKM	Non-Valve Nitrile	Non-Valve EPDM	
-8 AN	51508E	51508BE	51508FE	51508AE	51508CE	51508AFE	
-10AN	51510E	51510BE	51510FE	51510AE	51510CE	51510AFE	
-12AN	51512E	51512BE	51512FE	51512AE	51512CE	51512AFE	
Hose Barb Straight - Black							
Size	FKM	Nitrile	EPDM	Non-Valve FKM	Non-Valve Nitrile	Non-Valve EPDM	
-8 AN	51508J	51508BJ	51508FJ	51508AJ	51508CJ	51508AFJ	
-10AN	51510J	51510BJ	51510FJ	51510AJ	51510CJ	51510AFJ	
-12AN	51512J	51512BJ	51512FJ	51512AJ	51512CJ	51512AFJ	
Hose Barb 45° - Black							
Size	FKM	Nitrile	EPDM	Non-Valve FKM	Non-Valve Nitrile	Non-Valve EPDM	
-8 AN	51508JD	51508BJD	51508FJD	51508AJD	51508CJD	51508AFJD	
-10AN	51510JD	51510BJD	51510FJD	51510AJD	51510CJD	51510AFJD	
-12AN	51512JD	51512BJD	51512FJD	51512AJD	51512CJD	51512AFJD	
Hose Barb 90° - Black							
Size	FKM	Nitrile	EPDM	Non-Valve FKM	Non-Valve Nitrile	Non-Valve EPDM	
-8 AN	51508JE	51508BJE	51508FJE	51508AJE	51508CJE	51508AFJE	
-10AN	51510JE	51510BJE	51510FJE	51510AJE	51510CJE	51510AFJE	
-12AN	51512JE	51512BJE	51512FJE	51512AJE	51512CJE	51512AFJE	
Push To Lock Hose Barb Straight - Gold							
Size	FKM	Nitrile	EPDM	Non-Valve FKM	Non-Valve Nitrile	Non-Valve EPDM	
-8	51508P	51508BP	51508FP	51508AP	51508CP	51508AFP	
-10	51510P	51510BP	51510FP	51510AP	51510CP	51510AFP	
-12	51512P	51512BP	51512FP	51512AP	51512CP	51512AFP	
Push To Lock Hose Barb 45° - Gold							
Size	FKM	Nitrile	EPDM	Non-Valve FKM	Non-Valve Nitrile	Non-Valve EPDM	
-8	51508PD	51508BPD	51508FPD	51508APD	51508CPD	51508AFPD	
-10	51510PD	51510BPD	51510FPD	51510APD	51510CPD	51510AFPD	
-12	51512PD	51512BPD	51512FPD	51512APD	51512CPD	51512AFPD	
Push To Lock Hose Barb 90° - Gold							
Size	FKM	Nitrile	EPDM	Non-Valve FKM	Non-Valve Nitrile	Non-Valve EPDM	
-8	51508PE	51508BPE	51508FPE	51508APE	51508CPE	51508AFPE	
-10	51510PE	51510BPE	51510FPE	51510APE	51510CPE	51510AFPE	
-12	51512PE	51512BPE	51512FPE	51512APE	51512CPE	51512AFPE	

SOCKETS

Push To Lock Hose Barb Straight - Black

Size	FKM	Nitrile	EPDM	Non-Valve FKM	Non-Valve Nitrile	Non-Valve EPDM
-8	51508PJ	51508BPJ	51508FPJ	51508APJ	51508CPJ	51508AFPJ
-10	51510PJ	51510BPJ	51510FPJ	51510APJ	51510CPJ	51510AFPJ
-12	51512PJ	51512BPJ	51512FPJ	51512APJ	51512CPJ	51512AFPJ



Push To Lock Hose Barb 45° - Black

Size	FKM	Nitrile	EPDM	Non-Valve FKM	Non-Valve Nitrile	Non-Valve EPDM
-8	51508PJD	51508BPJD	51508FPJD	51508APJD	51508CPJD	51508AFPJD
-10	51510PJD	51510BPJD	51510FPJD	51510APJD	51510CPJD	51510AFPJD
-12	51512PJD	51512BPJD	51512FPJD	51512APJD	51512CPJD	51512AFPJD



Push To Lock Hose Barb 90° - Black

Size	FKM	Nitrile	EPDM	Non-Valve FKM	Non-Valve Nitrile	Non-Valve EPDM
-8	51508PJE	51508BPJE	51508FPJE	51508APJE	51508CPJE	51508AFPJE
-10	51510PJE	51510BPJE	51510FPJE	51510APJE	51510CPJE	51510AFPJE
-12	51512PJE	51512BPJE	51512FPJE	51512APJE	51512CPJE	51512AFPJE



Reusable Nut Hose End Straight - Gold

Size	FKM	Nitrile	EPDM	Non-Valve FKM	Non-Valve Nitrile	Non-Valve EPDM
-8 AN	51608	51608B	51608F	51608A	51608C	51608AF
-10AN	51610	51610B	51610F	51610A	51610C	51610AF
-12AN	51612	51612B	51612F	51612A	51612C	51612AF



Reusable Nut Hose End 45° - Gold

Size	FKM	Nitrile	EPDM	Non-Valve FKM	Non-Valve Nitrile	Non-Valve EPDM
-8 AN	51608D	51608BD	51608FD	51608AD	51608CD	51608AFD
-10AN	51610D	51610BD	51610FD	51610AD	51610CD	51610AFD
-12AN	51612D	51612BD	51612FD	51612AD	51612CD	51612AFD



Reusable Nut Hose End 90° - Gold

Size	FKM	Nitrile	EPDM	Non-Valve FKM	Non-Valve Nitrile	Non-Valve EPDM
-8 AN	51608E	51608BE	51608FE	51608AE	51608CE	51608AFE
-10AN	51610E	51610BE	51610FE	51610AE	51610CE	51610AFE
-12AN	51612E	51612BE	51612FE	51612AE	51612CE	51612AFE



Reusable Nut Hose End Straight - Black

Size	FKM	Nitrile	EPDM	Non-Valve FKM	Non-Valve Nitrile	Non-Valve EPDM
-8 AN	51608J	51608BJ	51608FJ	51608AJ	51608CJ	51608AFJ
-10AN	51610J	51610BJ	51610FJ	51610AJ	51610CJ	51610AFJ
-12AN	51612J	51612BJ	51612FJ	51612AJ	51612CJ	51612AFJ



Reusable Nut Hose End 45° - Black

Size	FKM	Nitrile	EPDM	Non-Valve FKM	Non-Valve Nitrile	Non-Valve EPDM
-8 AN	51608JD	51608BJD	51608FDJ	51608AFJD	51608CJD	51608AFJD
-10AN	51610JD	51610BJD	51610FDJ	51610AJD	51610CJD	51610AFJD
-12AN	51612JD	51612BJD	51612FDJ	51612AJD	51612CJD	51612AFJD



Reusable Nut Hose End 90° - Black

Size	FKM	Nitrile	EPDM	Non-Valve FKM	Non-Valve Nitrile	Non-Valve EPDM
-8 AN	51608JE	51608BJE	51608FJE	51608AJE	51608CJE	51608AFJE
-10AN	51610JE	51610BJE	51610FJE	51610AJE	51610CJE	51610AFJE
-12AN	51612JE	51612BJE	51612FJE	51612AJE	51612CJE	51612AFJE



SOCKETS

Female NPT Straight - Gold						
Size	FKM	Nitrile	EPDM	Non-Valve FKM	Non-Valve Nitrile	Non-Valve EPDM
3/8"	51706	51706B	51706F	51706A	51706C	51706AF
1/2"	51708	51708B	51708F	51708A	51708C	51708AF
3/4"	51712	51712B	51712F	51712A	51712C	51712AF
Female NPT 45° - Gold						
Size	FKM	Nitrile	EPDM	Non-Valve FKM	Non-Valve Nitrile	Non-Valve EPDM
3/8"	51706D	51706BD	51706FD	51706AD	51706CD	51706AFD
1/2"	51708D	51708BD	51708FD	51708AD	51708CD	51708AFD
3/4"	51712D	51712BD	51712FD	51712AD	51712CD	51712AFD
Female NPT 90° - Gold						
Size	FKM	Nitrile	EPDM	Non-Valve FKM	Non-Valve Nitrile	Non-Valve EPDM
3/8"	51706E	51706BE	51706FE	51706AE	51706CE	51706AFE
1/2"	51708E	51708BE	51708FE	51708AE	51708CE	51708AFE
3/4"	51712E	51712BE	51712FE	51712AE	51712CE	51712AFE
Female NPT Straight - Black						
Size	FKM	Nitrile	EPDM	Non-Valve FKM	Non-Valve Nitrile	Non-Valve EPDM
3/8"	51706J	51706BJ	51706FJ	51706AJ	51706CJ	51706AFJ
1/2"	51708J	51708BJ	51708FJ	51708AJ	51708CJ	51708AFJ
3/4"	51712J	51712BJ	51712FJ	51712AJ	51712CJ	51712AFJ
Female NPT 45° - Black						
Size	FKM	Nitrile	EPDM	Non-Valve FKM	Non-Valve Nitrile	Non-Valve EPDM
3/8"	51706JD	51706BJD	51706FJD	51706AJD	51706CJD	51706AFJD
1/2"	51708JD	51708BJD	51708FJD	51708AJD	51708CJD	51708AFJD
3/4"	51712JD	51712BJD	51712FJD	51712AJD	51712CJD	51712AFJD
Female NPT 90° - Black						
Size	FKM	Nitrile	EPDM	Non-Valve FKM	Non-Valve Nitrile	Non-Valve EPDM
3/8"	51706JE	51706BJE	51706FJE	51706AJE	51706CJE	51706AFJE
1/2"	51708JE	51708BJE	51708FJE	51708AJE	51708CJE	51708AFJE
3/4"	51712JE	51712BJE	51712FJE	51712AJE	51712CJE	51712AFJE
Male NPT Straight - Gold						
Size	FKM	Nitrile	EPDM	Non-Valve FKM	Non-Valve Nitrile	Non-Valve EPDM
3/8"	51806	51806B	51806F	51806A	51806C	51806AF
1/2"	51808	51808B	51808F	51808A	51808C	51808AF
3/4"	51812	51812B	51812F	51812A	51812C	51812AF
Male NPT 45° - Gold						
Size	FKM	Nitrile	EPDM	Non-Valve FKM	Non-Valve Nitrile	Non-Valve EPDM
3/8"	51806D	51806BD	51806FD	51806AD	51806CD	51806AFD
1/2"	51808D	51808BD	51808FD	51808AD	51808CD	51808AFD
3/4"	51812D	51812BD	51812FD	51812AD	51812CD	51812AFD
Male NPT 90° - Gold						
Size	FKM	Nitrile	EPDM	Non-Valve FKM	Non-Valve Nitrile	Non-Valve EPDM
3/8"	51806E	51806BE	51806FE	51806AE	51806CE	51806AFE
1/2"	51808E	51808BE	51808FE	51808AE	51808CE	51808AFE
3/4"	51812E	51812BE	51812FE	51812AE	51812CE	51812AFE

SOCKETS

Male NPT Straight - Black						
Size	FKM	Nitrile	EPDM	Non-Valve FKM	Non-Valve Nitrile	Non-Valve EPDM
3/8"	51806J	51806BJ	51806FJ	51806AJ	51806CJ	51806AFJ
1/2"	51808J	51808BJ	51808FJ	51808AJ	51808CJ	51808AFJ
3/4"	51812J	51812BJ	51812FJ	51812AJ	51812CJ	51812AFJ
Male NPT 45° - Black						
Size	FKM	Nitrile	EPDM	Non-Valve FKM	Non-Valve Nitrile	Non-Valve EPDM
3/8"	51806JD	51806BJD	51806FJD	51806AJD	51806CJD	51806AFJD
1/2"	51808JD	51808BJD	51808FJD	51808AJD	51808CJD	51808AFJD
3/4"	51812JD	51812BJD	51812FJD	51812AJD	51812CJD	51812AFJD
Male NPT 90° - Black						
Size	FKM	Nitrile	EPDM	Non-Valve FKM	Non-Valve Nitrile	Non-Valve EPDM
3/8"	51806JE	51806BJE	51806FJE	51806AJE	51806CJE	51806AFJE
1/2"	51808JE	51808BJE	51808FJE	51808AJE	51808CJE	51808AFJE
3/4"	51812JE	51812BJE	51812FJE	51812AJE	51812CJE	51812AFJE
5000 Series Socket Cap			5000 Series Plug Cap			
MS5000P	Fits Any 5000 Series Socket			MS5000C	Fits Any 5000 Series Plug	



PLUGS

Male O-Ring Boss Seal (ORB) Straight						
Size	FKM	Nitrile	EPDM	Non-Valve FKM	Non-Valve Nitrile	Non-Valve EPDM
-8	52108	52108B	52108F	52108A	52108C	52108AF
-10	52110	52110B	52110F	52110A	52110C	52110AF
-12	52112	52112B	52112F	52112A	52112C	52112AF
Male O-Ring Boss Seal (ORB) 45°						
Size	FKM	Nitrile	EPDM	Non-Valve FKM	Non-Valve Nitrile	Non-Valve EPDM
-8	52108D	52108BD	52108FD	52108AD	52108CD	52108AFD
-10	52110D	52110BD	52110FD	52110AD	52110CD	52110AFD
-12	52112D	52112BD	52112FD	52112AD	52112CD	52112AFD
Male O-Ring Boss Seal (ORB) 90°						
Size	FKM	Nitrile	EPDM	Non-Valve FKM	Non-Valve Nitrile	Non-Valve EPDM
-8	52108E	52108BE	52108FE	52108AE	52108CE	52108AFE
-10	52110E	52110BE	52110FE	52110AE	52110CE	52110AFE
-12	52112E	52112BE	52112FE	52112AE	52112CE	52112AFE
FEMALE 37° AN Straight						
Size	FKM	Nitrile	EPDM	Non-Valve FKM	Non-Valve Nitrile	Non-Valve EPDM
-8 AN	52308	52308B	52308F	52308A	52308C	52308AF
-10AN	52310	52310B	52310F	52310A	52310C	52310AF
-12AN	52312	52312B	52312F	52312A	52312C	52312AF
FEMALE 37° AN 45 Degree - Swivel						
Size	FKM	Nitrile	EPDM	Non-Valve FKM	Non-Valve Nitrile	Non-Valve EPDM
-8 AN	52308D	52308BD	52308FD	52308AD	52308CD	52308AFD
-10AN	52310D	52310BD	52310FD	52310AD	52310CD	52310AFD
-12AN	52312D	52312BD	52312FD	52312AD	52312CD	52312AFD
FEMALE 37° AN 90 Degree - Swivel						
Size	FKM	Nitrile	EPDM	Non-Valve FKM	Non-Valve Nitrile	Non-Valve EPDM
-8 AN	52308E	52308BE	52308FE	52308AE	52308CE	52308AFE
-10AN	52310E	52310BE	52310FE	52310AE	52310CE	52310AFE
-12AN	52312E	52312BE	52312FE	52312AE	52312CE	52312AFE
MALE 37° AN Straight						
Size	FKM	Nitrile	EPDM	Non-Valve FKM	Non-Valve Nitrile	Non-Valve EPDM
-8 AN	52408	52408B	52408F	52408A	52408C	52408AF
-10AN	52410	52410B	52410F	52410A	52410C	52410AF
-12AN	52412	52412B	52412F	52412A	52412C	52412AF
MALE 37° AN 45 Degree						
Size	FKM	Nitrile	EPDM	Non-Valve FKM	Non-Valve Nitrile	Non-Valve EPDM
-8 AN	52408D	52408BD	52408FD	52408AD	52408CD	52408AFD
-10AN	52410D	52410BD	52410FD	52410AD	52410CD	52410AFD
-12AN	52412D	52412BD	52412FD	52412AD	52412CD	52412AFD
MALE 37° AN 90 Degree						
Size	FKM	Nitrile	EPDM	Non-Valve FKM	Non-Valve Nitrile	Non-Valve EPDM
-8 AN	52408E	52408BE	52408FE	52408AE	52408CE	52408AFE
-10AN	52410E	52410BE	52410FE	52410AE	52410CE	52410AFE
-12AN	52412E	52412BE	52412FE	52412AE	52412CE	52412AFE



PLUGS

Hose Barb Straight						
Size	FKM	Nitrile	EPDM	Non-Valve FKM	Non-Valve Nitrile	Non-Valve EPDM
-8 AN	52508	52508B	52508F	52508A	52508C	52508AF
-10AN	52510	52510B	52510F	52510A	52510C	52510AF
-12AN	52512	52512B	52512F	52512A	52512C	52512AF
Hose Barb 45°						
Size	FKM	Nitrile	EPDM	Non-Valve FKM	Non-Valve Nitrile	Non-Valve EPDM
-8 AN	52508D	52508BD	52508FD	52508AD	52508CD	52508AFD
-10AN	52510D	52510BD	52510FD	52510AD	52510CD	52510AFD
-12AN	52512D	52512BD	52512FD	52512AD	52512CD	52512AFD
Hose Barb 90°						
Size	FKM	Nitrile	EPDM	Non-Valve FKM	Non-Valve Nitrile	Non-Valve EPDM
-8 AN	52508E	52508BE	52508FE	52508AE	52508CE	52508AFE
-10AN	52510E	52510BE	52510FE	52510AE	52510CE	52510AFE
-12AN	52512E	52512BE	52512FE	52512AE	52512CE	52512AFE
Push To Lock Hose Barb Straight						
Size	FKM	Nitrile	EPDM	Non-Valve FKM	Non-Valve Nitrile	Non-Valve EPDM
-8	52508P	52508BP	52508FP	52508AP	52508CP	52508AFP
-10	52510P	52510BP	52510FP	52510AP	52510CP	52510AFP
-12	52512P	52512BP	52512FP	52512AP	52512CP	52512AFP
Push To Lock Hose Barb 45°						
Size	FKM	Nitrile	EPDM	Non-Valve FKM	Non-Valve Nitrile	Non-Valve EPDM
-8	52508PD	52508BPD	52508FPD	52508APD	52508CPD	52508AFPD
-10	52510PD	52510BPD	52510FPD	52510APD	52510CPD	52510AFPD
-12	52512PD	52512BPD	52512FPD	52512APD	52512CPD	52512AFPD
Push To Lock Hose Barb 90°						
Size	FKM	Nitrile	EPDM	Non-Valve FKM	Non-Valve Nitrile	Non-Valve EPDM
-8	52508PE	52508BPE	52508FPE	52508APE	52508CPE	52508AFPE
-10	52510PE	52510BPE	52510FPE	52510APE	52510CPE	52510AFPE
-12	52512PE	52512BPE	52512FPE	52512APE	52512CPE	52512AFPE
Reusable Nut Hose End Straight - Gold						
Size	FKM	Nitrile	EPDM	Non-Valve FKM	Non-Valve Nitrile	Non-Valve EPDM
-8 AN	52608	52608B	52608F	52608A	52608C	52608AF
-10AN	52610	52610B	52610F	52610A	52610C	52610AF
-12AN	52612	52612B	52612F	52612A	52612C	52612AF
Reusable Nut Hose End 45° - Gold						
Size	FKM	Nitrile	EPDM	Non-Valve FKM	Non-Valve Nitrile	Non-Valve EPDM
-8 AN	52608D	52608BD	52608FD	52608AD	52608CD	52608AFD
-10AN	52610D	52610BD	52610FD	52610AD	52610CD	52610AFD
-12AN	52612D	52612BD	52612FD	52612AD	52612CD	52612AFD
Reusable Nut Hose End 90° - Gold						
Size	FKM	Nitrile	EPDM	Non-Valve FKM	Non-Valve Nitrile	Non-Valve EPDM
-8 AN	52608E	52608BE	52608FE	52608AE	52608CE	52608AFE
-10AN	52610E	52610BE	52610FE	52610AE	52610CE	52610AFE
-12AN	52612E	52612BE	52612FE	52612AE	52612CE	52612AFE



PLUGS

Reusable Nut Hose End Straight - Black							
Size	FKM	Nitrile	EPDM	Non-Valve FKM	Non-Valve Nitrile	Non-Valve EPDM	
-8 AN	52608J	52608BJ	52608FJ	52608AJ	52608CJ	52608AFJ	
-10AN	52610J	52610BJ	52610FJ	52610AJ	52610CJ	52610AFJ	
-12AN	52612J	52612BJ	52612FJ	52612AJ	52612CJ	52612AFJ	
Reusable Nut Hose End 45° - Black							
Size	FKM	Nitrile	EPDM	Non-Valve FKM	Non-Valve Nitrile	Non-Valve EPDM	
-8 AN	52608JD	52608BJD	52608FDJ	52608AFJD	52608CJD	52608AFJD	
-10AN	52610JD	52610BJD	52610FDJ	52610AJD	52610CJD	52610AFJD	
-12AN	52612JD	52612BJD	52612FDJ	52612AJD	52612CJD	52612AFJD	
Reusable Nut Hose End 90° - Black							
Size	FKM	Nitrile	EPDM	Non-Valve FKM	Non-Valve Nitrile	Non-Valve EPDM	
-8 AN	52608JE	52608BJE	52608FJE	52608AJE	52608CJE	52608AFJE	
-10AN	52610JE	52610BJE	52610FJE	52610AJE	52610CJE	52610AFJE	
-12AN	52612JE	52612BJE	52612FJE	52612AJE	52612CJE	52612AFJE	
Female NPT Straight							
Size	FKM	Nitrile	EPDM	Non-Valve FKM	Non-Valve Nitrile	Non-Valve EPDM	
3/8"	52706	52706B	52706F	52706A	52706C	52706AF	
1/2"	52708	52708B	52708F	52708A	52708C	52708AF	
3/4"	52712	52712B	52712F	52712A	52712C	52712AF	
Female NPT 45°							
Size	FKM	Nitrile	EPDM	Non-Valve FKM	Non-Valve Nitrile	Non-Valve EPDM	
3/8"	52706D	52706BD	52706FD	52706AD	52706CD	52706AFD	
1/2"	52708D	52708BD	52708FD	52708AD	52708CD	52708AFD	
3/4"	52712D	52712BD	52712FD	52712AD	52712CD	52712AFD	
Female NPT 90°							
Size	FKM	Nitrile	EPDM	Non-Valve FKM	Non-Valve Nitrile	Non-Valve EPDM	
3/8"	52706E	52706BE	52706FE	52706AE	52706CE	52706AFE	
1/2"	52708E	52708BE	52708FE	52708AE	52708CE	52708AFE	
3/4"	52712E	52712BE	52712FE	52712AE	52712CE	52712AFE	
Male NPT Straight							
Size	FKM	Nitrile	EPDM	Non-Valve FKM	Non-Valve Nitrile	Non-Valve EPDM	
3/8"	52806	52806B	52806F	52806A	52806C	52806AF	
1/2"	52808	52808B	52808F	52808A	52808C	52808AF	
3/4"	52812	52812B	52812F	52812A	52812C	52812AF	
Male NPT 45°							
Size	FKM	Nitrile	EPDM	Non-Valve FKM	Non-Valve Nitrile	Non-Valve EPDM	
3/8"	52806D	52806BD	52806FD	52806AD	52806CD	52806AFD	
1/2"	52808D	52808BD	52808FD	52808AD	52808CD	52808AFD	
3/4"	52812D	52812BD	52812FD	52812AD	52812CD	52812AFD	
Male NPT 90°							
Size	FKM	Nitrile	EPDM	Non-Valve FKM	Non-Valve Nitrile	Non-Valve EPDM	
3/8"	52806E	52806BE	52806FE	52806AE	52806CE	52806AFE	
1/2"	52808E	52808BE	52808FE	52808AE	52808CE	52808AFE	
3/4"	52812E	52812BE	52812FE	52812AE	52812CE	52812AFE	

All sockets and plugs in the same series are interchangeable

CARBURETOR

Sockets are available in straight, 45°, and 90°, and you have the choice of gold or black anodized finish. For seal compatibility information, see page 4.



7/8" - 20 UNEF - Straight - Gold

Size	FKM	Nitrile	EPDM
-6AN	200C1	200C1B	200C1F
-8AN	300C1	300C1B	300C1F



7/8" - 20 UNEF - Straight - Black

Size	FKM	Nitrile	EPDM
-6AN	200C1J	200C1BJ	200C1FJ
-8AN	300C1J	300C1BJ	300C1FJ



7/8" - 20 UNEF - 45° - Gold

Size	FKM	Nitrile	EPDM
-6AN	200C1D	200C1BD	200C1FD
-8AN	300C1D	300C1BD	300C1FD



7/8" - 20 UNEF - 45° - Black

Size	FKM	Nitrile	EPDM
-6AN	200C1JD	200C1BJD	200C1FJD
-8AN	300C1JD	300C1BJD	300C1FJD



7/8" - 20 UNEF - 90° - Gold

Size	FKM	Nitrile	EPDM
-6AN	200C1E	200C1BE	200C1FE
-8AN	300C1E	300C1BE	300C1FE



7/8" - 20 UNEF - 90° - Black

Size	FKM	Nitrile	EPDM
-6AN	200C1JE	200C1BJE	200C1FJE
-8AN	300C1JE	300C1BJE	300C1FJE



9/16" - 24 UNEF - Straight - Gold

Size	FKM	Nitrile	EPDM
-6AN	200C4	200C4B	200C4F
-8AN	300C4	300C4B	300C4F



9/16" - 24 UNEF - 45° - Gold

Size	FKM	Nitrile	EPDM
-6AN	200C4D	200C4BD	200C4FD
-8AN	300C4D	300C4BD	300C4FD



9/16" - 24 UNEF - 90° - Gold

Size	FKM	Nitrile	EPDM
-6AN	200C4E	200C4BE	200C4FE
-8AN	300C4E	300C4BE	300C4FE



9/16" - 24 UNEF - Straight - Black

Size	FKM	Nitrile	EPDM
-6AN	200C4J	200C4BJ	200C4FJ
-8AN	300C4J	300C4BJ	300C4FJ



9/16" - 24 UNEF - 45° - Black

Size	FKM	Nitrile	EPDM
-6AN	200C4JD	200C4BJD	200C4FJD
-8AN	300C4JD	300C4BJD	300C4FJD



9/16" - 24 UNEF - 90° - Black

Size	FKM	Nitrile	EPDM
-6AN	200C4JE	200C4BJE	200C4FJE
-8AN	300C4JE	300C4BJE	300C4FJE



5/8" - 20 UNEF - Straight - Gold

Size	FKM	Nitrile	EPDM
-6AN	200C7	200C7B	200C7F
-8AN	300C7	300C7B	300C7F



5/8" - 20 UNEF - 45° - Gold

Size	FKM	Nitrile	EPDM
-6AN	200C7D	200C7BD	200C7FD
-8AN	300C7D	300C7BD	300C7FD



5/8" - 20 UNEF - 90° - Gold

Size	FKM	Nitrile	EPDM
-6AN	200C7E	200C7BE	200C7FE
-8AN	300C7E	300C7BE	300C7FE

All sockets and plugs in the same series are interchangeable



5/8" - 20 UNEF - Straight - Black

Size	FKM	Nitrile	EPDM
-6AN	200C7J	200C7BJ	200C7FJ
-8AN	300C7J	300C7BJ	300C7FJ



5/8" - 20 UNEF - 45° - Black

Size	FKM	Nitrile	EPDM
-6AN	200C7JD	200C7BJD	200C7FJD
-8AN	300C7JD	300C7BJD	300C7FJD



5/8" - 20 UNEF - 90° - Gold

Size	FKM	Nitrile	EPDM
-6AN	200C7JE	200C7BJE	200C7FJE
-8AN	300C7JE	300C7BJE	300C7FJE



1" - 20 UNEF - Straight - Gold

Size	FKM	Nitrile	EPDM
-6AN	200C8	200C8B	200C8F
-8AN	300C8	300C8B	300C8F



1" - 20 UNEF - 45° - Gold

Size	FKM	Nitrile	EPDM
-6AN	200C8D	200C8BD	200C8FD
-8AN	300C8D	300C8BD	300C8FD



1" - 20 UNEF - 90° - Gold

Size	FKM	Nitrile	EPDM
-6AN	200C8E	200C8BE	200C8FE
-8AN	300C8E	300C8BE	300C8FE



1" - 20 UNEF - Straight - Black

Size	FKM	Nitrile	EPDM
-6AN	200C8J	200C8BJ	200C8FJ
-8AN	300C8J	300C8BJ	300C8FJ



1" - 20 UNEF - 45° - Black

Size	FKM	Nitrile	EPDM
-6AN	200C8JD	200C8BJD	200C8FJD
-8AN	300C8JD	300C8BJD	300C8FJD



1" - 20 UNEF - 90° - Black

Size	FKM	Nitrile	EPDM
-6AN	200C8JE	200C8BJE	200C8FJE
-8AN	300C8JE	300C8BJE	300C8FJE

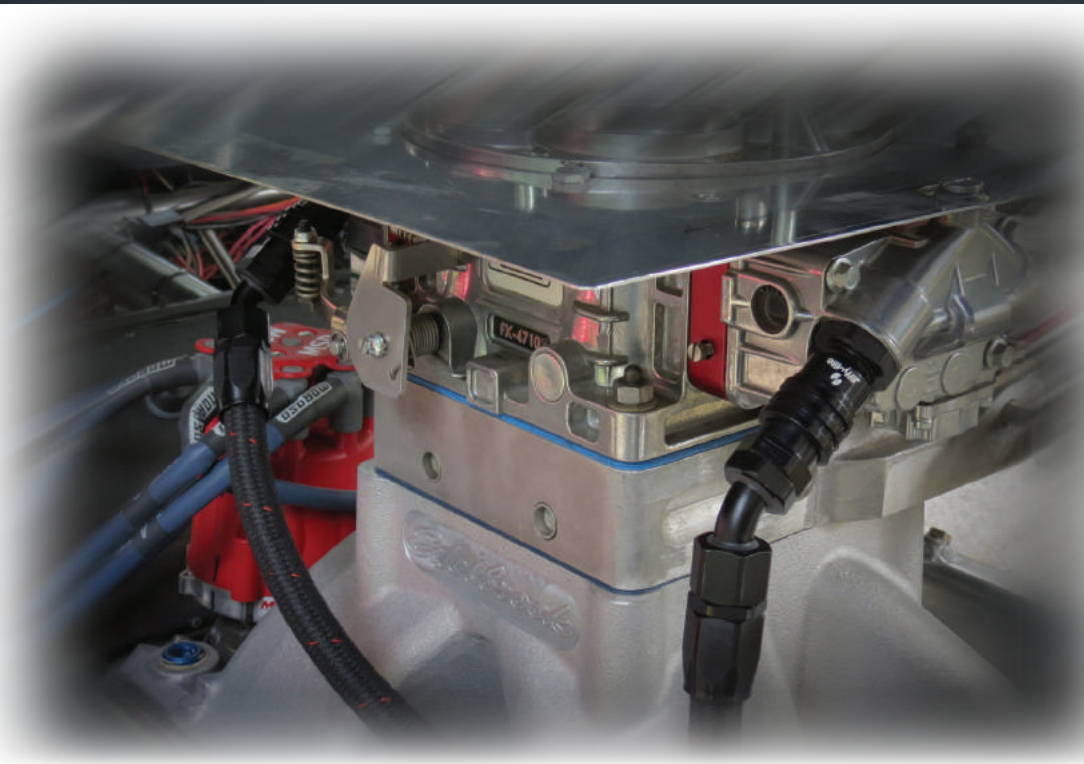

-8 O-Ring Boss - Straight - Gold

Size	FKM	Nitrile	EPDM
-6AN	200C10	200C10B	200C10F
-8AN	300C10	300C10B	300C10F



-8 O-Ring Boss - Straight - Black

Size	FKM	Nitrile	EPDM
-6AN	200C10J	200C10BJ	200C10FJ
-8AN	300C10J	300C10BJ	300C10FJ



-8 O-Ring Boss - 45° - Gold

Size	FKM	Nitrile	EPDM
-6AN	200C10D	200C10BD	200C10FD
-8AN	300C10D	300C10BD	300C10FD



-8 O-Ring Boss - 45° - Black

Size	FKM	Nitrile	EPDM
-6AN	200C10JD	200C10BJD	200C10FJD
-8AN	300C10JD	300C10BJD	300C10FJD



-8 O-Ring Boss - 90° - Gold

Size	FKM	Nitrile	EPDM
-6AN	200C10E	200C10BE	200C10FE
-8AN	300C10E	300C10BE	300C10FE



-8 O-Ring Boss - 90° - Black

Size	FKM	Nitrile	EPDM
-6AN	200C10JE	200C10BJE	200C10FJE
-8AN	300C10JE	300C10BJE	300C10FJE

All sockets and plugs in the same series are interchangeable

CARBURETOR PLUGS

7/8" - 20 UNEF			
Size	FKM	Nitrile	EPDM
-6AN	220C1	220C1B	220C1F
-8AN	320C1	320C1B	320C1F



9/16" - 24 UNEF			
Size	FKM	Nitrile	EPDM
-6AN	220C4	220C4B	220C4F
-8AN	320C4	320C4B	320C4F



5/8" - 24 UNEF			
Size	FKM	Nitrile	EPDM
-6AN	220C7	220C7B	220C7F
-8AN	320C7	320C7B	320C7F



1" - 20 UNEF			
Size	FKM	Nitrile	EPDM
-6AN	220C8	220C8B	220C8F
-8AN	320C8	320C8B	320C8F



-8 O-Ring Boss			
Size	FKM	Nitrile	EPDM
-6AN	220C10	220C10B	220C10F
-8AN	320C10	320C10B	320C10F

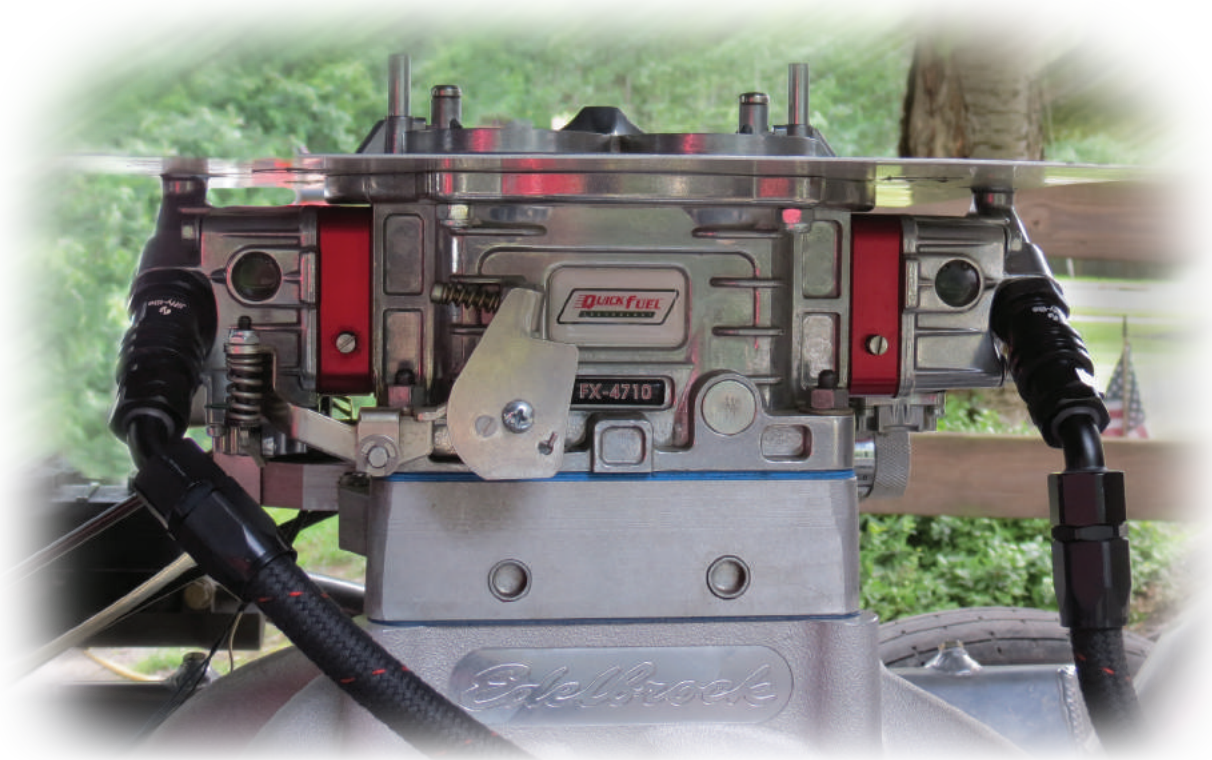

TRANSMISSION

Changeovers are a breeze with the Jiffy-tite Transmission Kit. By connecting and disconnecting in seconds without any tools you can reduce your time substantially. Simply disconnect the self sealing quick-connect fittings and the job is done with no leaks or mess.





Jiffy-tite Transmission kits are available to fit virtually all transmissions.

ALL KITS ARE AVAILABLE IN -6 AN AND COME STANDARD VALVED WITH FLUOROCARBON (FKM) SEALS.

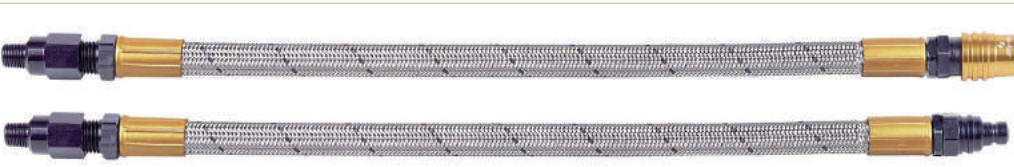
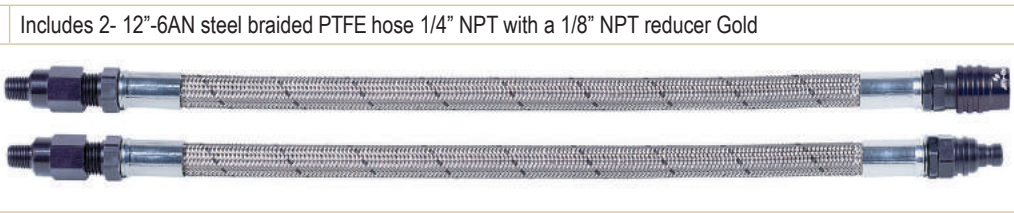

Part Number	Description
200T1	Includes 2 -12" -6AN steel braided rubber hose 1/4" NPT with a 1/8" NPT reducer, one plug (22406) and one socket (21406) Gold
200T1J	Includes 2 -12" -6AN steel braided rubber hose 1/4" NPT with a 1/8" NPT reducer, one plug (22406) and one socket (21406J) Black
200T2	Includes 2 -12" -6AN steel braided rubber hose 1/4" NPT with a 1/8" NPT reducer Gold
200T2J	Includes 2 -12" -6AN steel braided rubber hose 1/4" NPT with a 1/8" NPT reducer Black
Part Number	Description
200T1T	Includes 2 -12" -6AN steel braided PTFE hose 1/4" NPT with a 1/8" NPT reducer, one plug (22406) and one socket (21406) Gold
200T1JT	Includes 2 -12" -6AN steel braided PTFE hose 1/4" NPT with a 1/8" NPT reducer, one plug (22406) and one socket (21406J) Black

All sockets and plugs in the same series are interchangeable

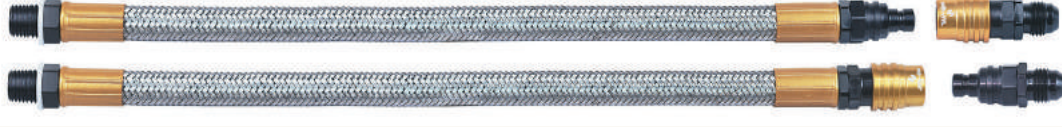
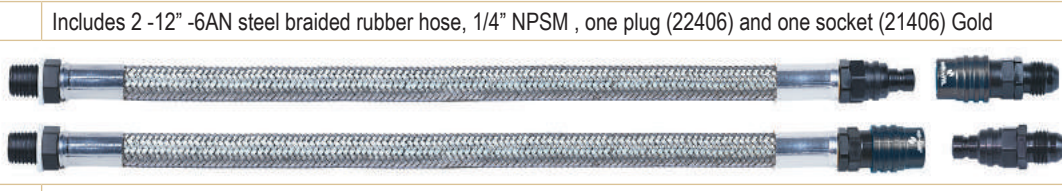
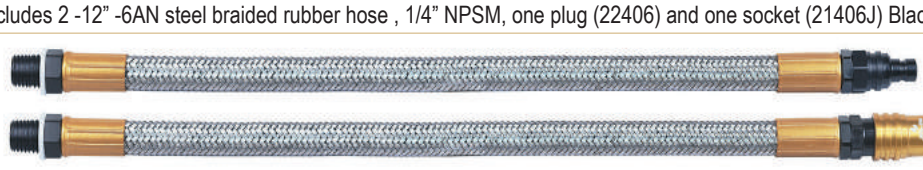
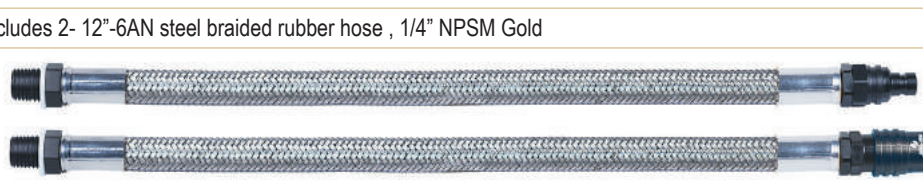
	<p>200T2T Includes 2- 12"-6AN steel braided PTFE hose 1/4" NPT with a 1/8" NPT reducer Gold</p>
	<p>200T2JT Includes 2- 12"-6AN steel braided PTFE hose 1/4" NPT with a 1/8" NPT reducer Black</p>
<p>Part Number Description</p>	
	<p>200T3 Includes 2- 45° brass elbows in 1/8" NPT with 2 plugs and 2 sockets (21606) Gold</p>
<p>Part Number Description</p>	<p>200T3J Includes 2- 45° brass elbows in 1/8" NPT with 2 plugs and 2 sockets (21606J) Black</p>
	
<p>200T4 Includes 2- 45° brass elbows in 1/4" NPT with 2 plugs and 2 sockets (21606) Gold</p>	<p>200T4J Includes 2- 45° brass elbows in 1/4" NPT with 2 plugs and 2 sockets (21606J) Black</p>
<p>Part Number Description</p>	
	<p>200T5 Includes 2 -12" -6AN steel braided rubber hose , 1/4" NPSM , one plug (22406) and one socket (21406) Gold</p>
	<p>200T5J Includes 2 -12" -6AN steel braided rubber hose , 1/4" NPSM, one plug (22406) and one socket (21406J) Black</p>
	<p>200T6 Includes 2- 12"-6AN steel braided rubber hose , 1/4" NPSM Gold</p>
	<p>200T6J Includes 2- 12"-6AN steel braided rubber hose , 1/4" NPSM Black</p>

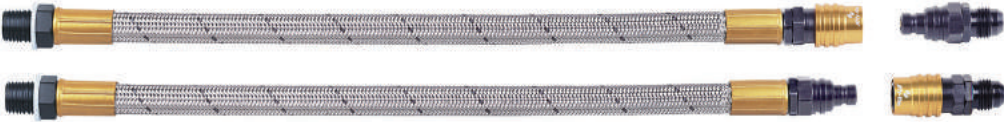
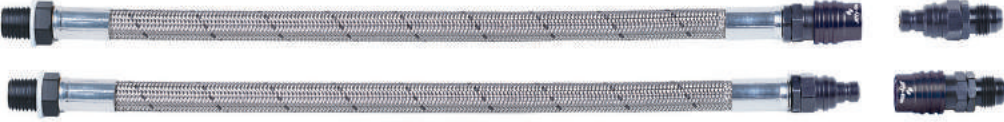
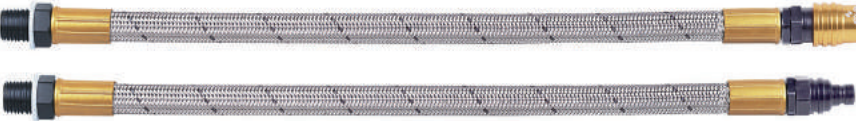
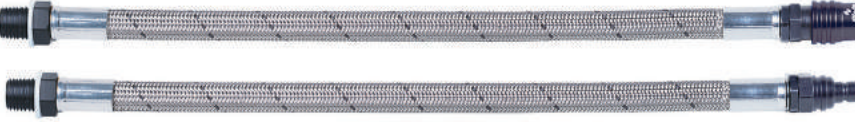
Part Number	Description
	
200T7T	Includes 2 -12" -6AN steel braided PTFE hose , 1/4" NPSM , one plug (22406) and one socket (21406) Gold
	
200T7JT	Includes 2 -12" -6AN steel braided PTFE hose , 1/4" NPSM , one plug (22406) and one socket (21406J) Black
	
200T8T	Includes 2 -12"-6AN steel braided PTFE hose , 1/4" NPSM Gold
	
200T8JT	Includes 2 -12" -6AN steel braided PTFE hose , 1/4" NPSM Black

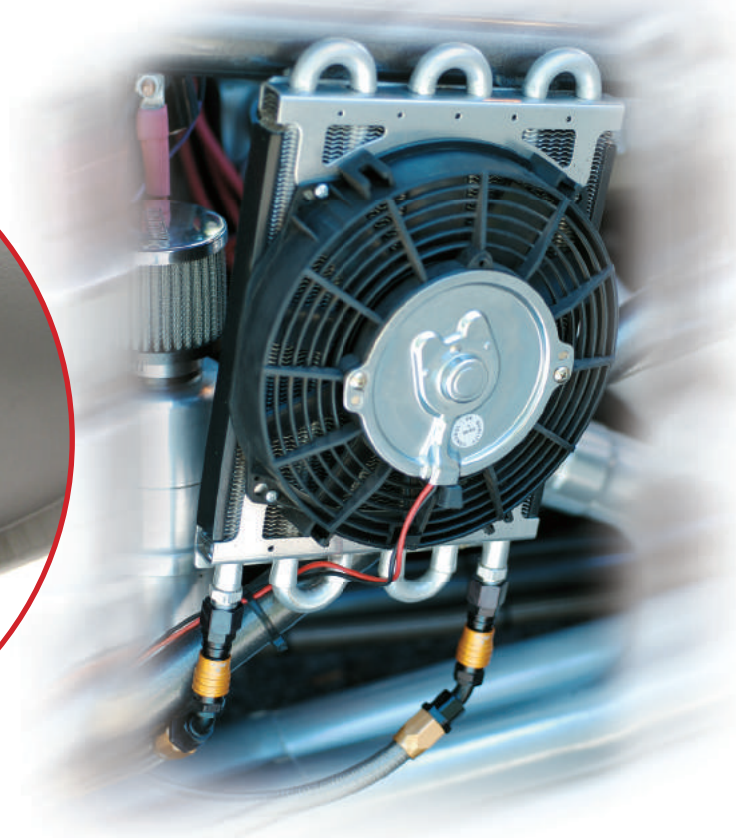

Jiffy-tite Pro-Compact Series is the perfect choice anywhere valved technology is not required

Jiffy-tite's compact line of AN sized fittings are here! Comparable in size to AN sized fittings on the market today, Jiffy-tite's Pro-Compact Series is the perfect choice for anywhere valved technology is not a requirement. Jiffy-tite products are engineered to perform.



Sockets available in:

- Female 37° AN -4AN through -20AN
- Male 37° AN -4AN through -20AN
- Hose Barb -4AN through -12AN
- Push to Lock Hose Barb -4 through -12
- Reusable Nut Hose End -4AN through -20AN

Plugs available in:

- O-Ring Boss -4 through -12
- Female 37° AN -4AN through -20AN
- Male 37° AN -4AN through -20AN
- Male NPT 1/8" through 1"



Available in straight, 45° or 90°

Pro-Compact Series Advantage

- Easily connects and disconnects by hand in seconds – no tools needed!
- Lightweight
- Excellent wear resistance
- Ruggedly constructed from 6061-T6 aluminum
- Connectors swivel 360° after connection has been made
- Available for virtually any fuel, water, oil, or transmission applications
- Replaces nearly any fitting in any location
- Sockets are available in black or gold anodized finish
- Made in the USA

Avoid these common problems with threaded AN fittings:

1. Stripping
2. Cross-threading
3. Over-tightening – leading to breakage
4. Forgetting to tighten
5. Stripping the hex – by using the incorrect tool
6. Scratching the fitting by frequent wrenching – destroys the aesthetics of the fitting

Jiffy-tite fittings are fast and easy to use:

Quick-connect fittings connect and disconnect in seconds without requiring any tools.

To connect, pull back on the socket collar, insert the plug and release the collar.

To disconnect, pull back on the socket collar.

Available for virtually any fuel, water, oil or transmission system today, Jiffy-tite's Pro-Compact Series is engineered to perform.



Sockets are available in stealth black or gold anodized finish.

Note:

Pro-Compact Series cannot be used with 2000, 3000, or 5000 series quick-connect sockets, plugs, transmission kits, or carburetor kits.

PRESSURE

Maximum Operating Pressure : 200 PSI
1.38 MPa

TEMPERATURE

-40° - 350° Fahrenheit
-40° - 177° C

AN 37° THREAD SIZES

Pictured are actual sizes of common AN thread sizes. To determine what size fitting you have, lay your fitting over the appropriate drawing.

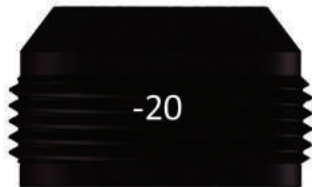

AN SIZE	METAL TUBE O.D.	THREAD SIZE
-3	3/16"	3/8-24 UNF
-4	1/4"	7/16-20 UNF
-6	3/8"	9/16-18 UNF
-8	1/2"	3/4-16 UNF
-10	5/8"	7/8-134 UNF
-12	3/4"	1-1/16-12 UN
-16	7/8"	1-5/16-12 UN
-20	1"	1-5/8-12 UN

NPT PIPE THREAD SIZES

Pictured are actual sizes of common NPT thread sizes. To determine what size fitting you have, lay your fitting over the appropriate drawing.



NPT PIPE THREAD SIZE	THREADS PER INCH	CLOSEST AN FITTING SIZE
1/8"	27	-4
1/4"	18"	-6
3/8"	18"	-8
1/2"	14	-10
3/4"	14	-12
1"	11-12	-16

MALE O-RING BOSS SEAL (ORB) THREAD SIZES

Pictured are actual sizes of common SAE male o-ring boss seal thread sizes. To determine what size fitting you have, lay your fitting over the appropriate drawing.



AN SIZE	METAL TUBE O.D.	THREAD SIZE
-4	1/4"	7/16-20 UNF
-6	3/8"	9/16-18 UNF
-8	1/2"	3/4-16 UNF
-10	5/8"	7/8-134 UNF
-12	3/4"	1-1/16-12 UN

All Pro-Compact sockets and plugs in the same series are interchangeable

Pro-Compact

SERIES

SERIES	A	B	C	D	E	F
20	.15	.31	.75	.60	.84	1.04
30	.24	.39	.88	.67	.91	1.18
40	.36	.54	1.10	.91	1.11	1.50
50	.48	.66	1.25	.92	1.16	1.56
60	.60	.79	1.38	1.10	1.16	1.57
80	.75	.94	1.75	1.12	1.31	1.77
100	1.00	1.19	2.00	1.18	1.31	1.85

SERIES	A	B	C	D	E	F	G	H	J	K	L
20	.15	.31	.75	.86	.97	1.42	4.00	2.23	1.30	2.17	1.32
30	.24	.39	.88	.91	1.04	1.55	4.08	2.30	1.36	2.18	1.34
40	.36	.54	1.10	1.30	1.46	2.17	5.31	3.03	1.69	2.87	1.65
50	.48	.66	1.25	1.49	1.66	2.56	6.66	3.72	2.19	3.54	2.16
60	.60	.79	1.38	1.67	1.82	2.73	6.88	3.88	2.24	3.78	2.28
80	.75	.94	1.75	1.81	1.93	2.99	7.94	4.41	2.64	4.28	2.64
100	1.00	1.19	2.00	1.90	2.02	3.16	8.24	4.56	2.88	4.44	2.88

SERIES	A	B	C	D	E	F	G	H	J	K	L
20	.15	.31	.75	.86	.97	1.42	3.38	1.91	1.62	1.87	1.59
30	.24	.39	.88	.91	1.04	1.55	3.40	1.98	1.68	1.82	1.66
40	.36	.54	1.10	1.30	1.46	2.17	4.72	2.74	2.12	2.58	2.08
50	.48	.66	1.25	1.49	1.66	2.56	6.12	3.44	2.90	3.27	2.87
60	.60	.79	1.38	1.67	1.82	2.73	6.36	3.60	2.94	3.53	2.94
80	.75	.94	1.75	1.81	1.93	2.99	7.71	4.29	3.49	4.17	3.49
100	1.00	1.19	2.00	1.90	2.02	3.16	7.91	4.39	3.58	4.27	3.58

DIMENSIONS

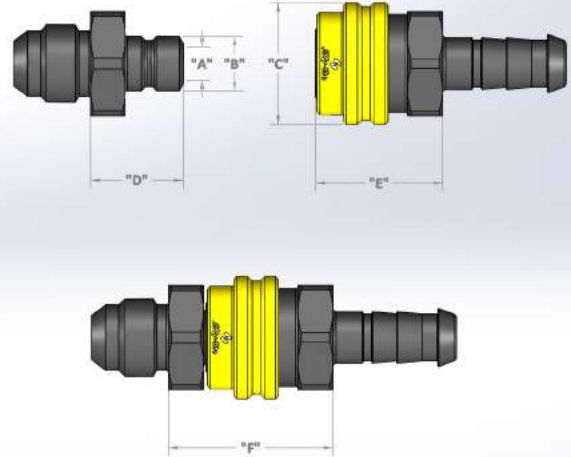

STRAIGHT

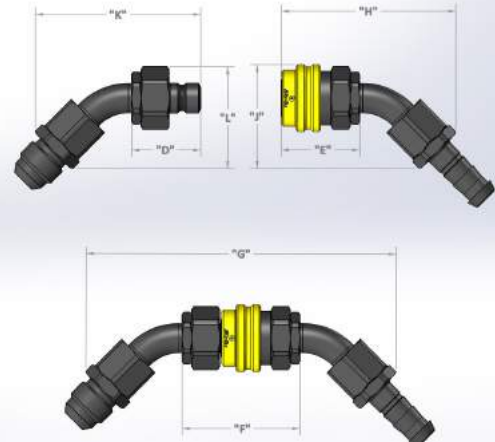

45 DEG

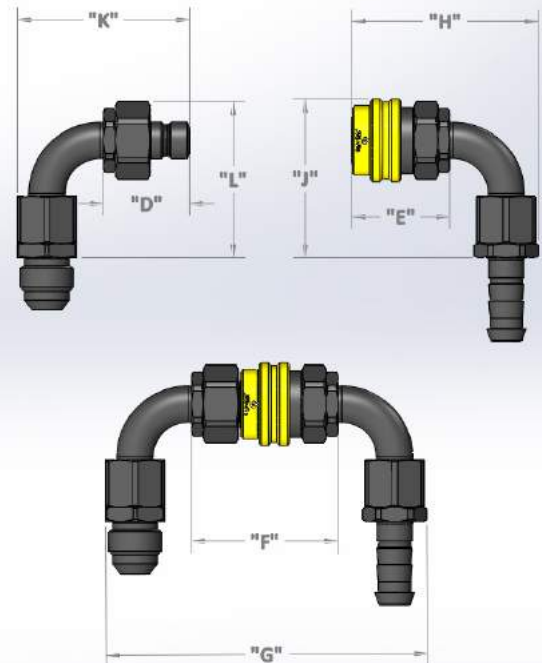

90 DEG

Pro-Compact

All Pro-Compact sockets and plugs in the same series are interchangeable

Female 37° AN

Female 37° AN Straight - Gold

Series	Size	FKM	Nitrile	EPDM
20	-4 AN	28304	28304B	28304F
30	-4 AN	38304	38304B	38304F
30	-6 AN	38306	38306B	38306F
40	-6 AN	48306	48306B	48306F
40	-8 AN	48308	48308B	48308F
50	-8 AN	58308	58308B	58308F
50	-10 AN	58310	58310B	58310F
60	-10 AN	68310	68310B	68310F
60	-12 AN	68312	68312B	68312F
80	-12 AN	88312	88312B	88312F
80	-16 AN	88316	88316B	88316F
100	-16 AN	18316	18316B	18316F
100	-20 AN	18320	18320B	18320F

Female 37° AN 45 Degree - Gold - Swivel

Series	Size	FKM	Nitrile	EPDM
20	-4 AN	28304D	28304BD	28304FD
30	-4 AN	38304D	38304BD	38304FD
30	-6 AN	38306D	38306BD	38306FD
40	-6 AN	48306D	48306BD	48306FD
40	-8 AN	48308D	48308BD	48308FD
50	-8 AN	58308D	58308BD	58308FD
50	-10 AN	58310D	58310BD	58310FD
60	-10 AN	68310D	68310BD	68310FD
60	-12 AN	68312D	68312BD	68312FD
80	-12 AN	88312D	88312BD	88312FD
80	-16 AN	88316D	88316BD	88316FD
100	-16 AN	18316D	18316BD	18316FD
100	-20 AN	18320D	18320BD	18320FD

Female 37° AN 90 Degree - Gold - Swivel

Series	Size	FKM	Nitrile	EPDM
20	-4 AN	28304E	28304BE	28304FE
30	-4 AN	38304E	38304BE	38304FE
30	-6 AN	38306E	38306BE	38306FE
40	-6 AN	48306E	48306BE	48306FE
40	-8 AN	48308E	48308BE	48308FE
50	-8 AN	58308E	58308BE	58308FE
50	-10 AN	58310E	58310BE	58310FE
60	-10 AN	68310E	68310BE	68310FE
60	-12 AN	68312E	68312BE	68312FE
80	-12 AN	88312E	88312BE	88312FE
80	-16 AN	88316E	88316BE	88316FE
100	-12 AN	18316E	18316BE	18316FE
100	-20 AN	18320E	18320BE	18320FE



All Pro-Compact sockets and plugs in the same series are interchangeable

Pro-Compact

SERIES

Sockets

Female 37° AN

Female 37° AN Straight - Black

Series	Size	FKM	Nitrile	EPDM
20	-4 AN	28304J	28304BJ	28304FJ
30	-4 AN	38304J	38304BJ	38304FJ
30	-6 AN	38306J	38306BJ	38306FJ
40	-6 AN	48306J	48306BJ	48306FJ
40	-8 AN	48308J	48308BJ	48308FJ
50	-8 AN	58308J	58308BJ	58308FJ
50	-10 AN	58310J	58310BJ	58310FJ
60	-10 AN	68310J	68310BJ	68310FJ
60	-12 AN	68312J	68312BJ	68312FJ
80	-12 AN	88312J	88312BJ	88312FJ
80	-16 AN	88316J	88316BJ	88316FJ
100	-16 AN	18316J	18316BJ	18316FJ
100	-20 AN	18320J	18320BJ	18320FJ



Female 37° AN 45 Degree - Black - Swivel

Series	Size	FKM	Nitrile	EPDM
20	-4 AN	28304JD	28304BJD	28304FJD
30	-4 AN	38304JD	38304BJD	38304FJD
30	-6 AN	38306JD	38306BJD	38306FJD
40	-6 AN	48306JD	48306BJD	48306FJD
40	-8 AN	48308JD	48308BJD	48308FJD
50	-8 AN	58308JD	58308BJD	58308FD
50	-10 AN	58310JD	58310BJD	58310FJD
60	-10 AN	68310JD	68310BJD	68310FJD
60	-12 AN	68312JD	68312BJD	68312FJD
80	-12 AN	88312JD	88312BJD	88312FJD
80	-16 AN	88316JD	88316BJD	88316FJD
100	-16 AN	18316JD	18316BJD	18316FJD
100	-20 AN	18320JD	18320BJD	18320FJD



Female 37° AN 90 Degree - Black - Swivel

Series	Size	FKM	Nitrile	EPDM
20	-4 AN	28304JE	28304BJE	28304FJE
30	-4 AN	38304JE	38304BJE	38304FJE
30	-6 AN	38306JE	38306BJE	38306FJE
40	-6 AN	48306JE	48306BJE	48306FJE
40	-8 AN	48308JE	48308BJE	48308FJE
50	-8 AN	58308JE	58308BJE	58308FJE
50	-10 AN	58310JE	58310BJE	58310FJE
60	-10 AN	68310JE	68310BJE	68310FJE
60	-12 AN	68312JE	68312BJE	68312FJE
80	-12 AN	88312JE	88312BJE	88312FJE
80	-16 AN	88316JE	88316BJE	88316FJE
100	-16 AN	18316JE	18316BJE	18316FJE
100	-20 AN	18320JE	18320BJE	18320FJE



Pro-Compact

All Pro-Compact sockets and plugs in the same series are interchangeable

Male 37° AN

Male 37° AN Straight - Gold

Series	Size	FKM	Nitrile	EPDM
20	-4 AN	28404	28404B	28404F
30	-4 AN	38404	38404B	38404F
30	-6 AN	38406	38406B	38406F
40	-6 AN	48406	48406B	48406F
40	-8 AN	48408	48408B	48408F
50	-8 AN	58408	58408B	58408F
50	-10 AN	58410	58410B	58410F
60	-10 AN	68410	68410B	68410F
60	-12 AN	68412	68412B	68412F
80	-12 AN	88412	88412B	88412F
80	-16 AN	88416	88416B	88416F
100	-16 AN	18416	18416B	18416F
100	-20 AN	18420	18420B	18420F

Male 37° AN 45 Degree - Gold

Series	Size	FKM	Nitrile	EPDM
20	-4 AN	28404D	28404BD	28404FD
30	-4 AN	38404D	38404BD	38404FD
30	-6 AN	38406D	38406BD	38406FD
40	-6 AN	48406D	48406BD	48406FD
40	-8 AN	48408D	48408BD	48408FD
50	-8 AN	58408D	58408BD	58408FD
50	-10 AN	58410D	58410BD	58410FD
60	-10 AN	68410D	68410BD	68410FD
60	-12 AN	68412D	68412BD	68412FD
80	-12 AN	88412D	88412BD	88412FD
80	-16 AN	88416D	88416BD	88416FD
100	-16 AN	18416D	18416BD	18416FD
100	-20 AN	18420D	18420BD	18420FD

Male 37° AN 90 Degree - Gold

Series	Size	FKM	Nitrile	EPDM
20	-4 AN	28404E	28404BE	28404FE
30	-4 AN	38404E	38404BE	38404FE
30	-6 AN	38406E	38406BE	38406FE
40	-6 AN	48406E	48406BE	48406FE
40	-8 AN	48408E	48408BE	48408FE
50	-8 AN	58408E	58408BE	58408FE
50	-10 AN	58410E	58410BE	58410FE
60	-10 AN	68410E	68410BE	68410FE
60	-12 AN	68412E	68412BE	68412FE
80	-12 AN	88412E	88412BE	88412FE
80	-16 AN	88416E	88416BE	88416FE
100	-16 AN	18416E	18416BE	18416FE
100	-20 AN	18420E	18420BE	18420FE



All Pro-Compact sockets and plugs in the same series are interchangeable

Pro-Compact

SERIES

Sockets

Male 37° AN

Male 37° AN Straight - Black

Series	Size	FKM	Nitrile	EPDM
20	-4 AN	28404J	28404BJ	28404FJ
30	-4 AN	38404J	38404BJ	38404FJ
30	-6 AN	38406J	38406BJ	38406FJ
40	-6 AN	48406J	48406BJ	48406FJ
40	-8 AN	48408J	48408BJ	48408FJ
50	-8 AN	58408J	58408BJ	58408FJ
50	-10 AN	58410J	58410BJ	58410FJ
60	-10 AN	68410J	68410BJ	68410FJ
60	-12 AN	68412J	68412BJ	68412FJ
80	-12 AN	88412J	88412BJ	88412FJ
80	-16 AN	88416J	88416BJ	88416FJ
100	-16 AN	18316J	18316BJ	18316FJ
100	-20 AN	18320J	18320BJ	18320FJ

Male 37° AN 45 Degree - Black

Series	Size	FKM	Nitrile	EPDM
20	-4 AN	28404JD	28404BJD	28404FJD
30	-4 AN	38404JD	38404BJD	38404FJD
30	-6 AN	38406JD	38406BJD	38406FJD
40	-6 AN	48406JD	48406BJD	48406FJD
40	-8 AN	48408JD	48408BJD	48408FJD
50	-8 AN	58408JD	58408BJD	58408FJD
50	-10 AN	58410JD	58410BJD	58410FJD
60	-10 AN	68410JD	68410BJD	68410FJD
60	-12 AN	68412JD	68412BJD	68412FJD
80	-12 AN	88412JD	88412BJD	88412FJD
80	-16 AN	88416JD	88416BJD	88416FJD
100	-16 AN	18416JD	18416BJD	18416FJD
100	-20 AN	18420JD	18420BJD	18420FJD

Male 37° AN 90 Degree - Black

Series	Size	FKM	Nitrile	EPDM
20	-4 AN	28404JE	28404BJE	28404FJE
30	-4 AN	38404JE	38404BJE	38404FJE
30	-6 AN	38406JE	38406BJE	38406FJE
40	-6 AN	48406JE	48406BJE	48406FJE
40	-8 AN	48408JE	48408BJE	48408FJE
50	-8 AN	58408JE	58408BJE	58408FJE
50	-10 AN	58410JE	58410BJE	58410FJE
60	-10 AN	68410JE	68410BJE	68410FJE
60	-12 AN	68412JE	68412BJE	68412FJE
80	-12 AN	88412JE	88412BJE	88412FJE
80	-16 AN	88416JE	88416BJE	88416FJE
100	-16 AN	18416JE	18416BJE	18416FJE
100	-20 AN	18420JE	18420BJE	18420FJE



Pro-Compact

All Pro-Compact sockets and plugs in the same series are interchangeable

Hose Barb

Hose Barb Straight - Gold

Series	Size	FKM	Nitrile	EPDM
20	-4 AN	28504	28504B	28504F
30	-4 AN	38504	38504B	38504F
30	-6 AN	38506	38506B	38506F
40	-6 AN	48506	48506B	48506F
40	-8 AN	48508	48508B	48508F
50	-8 AN	58508	58508B	58508F
50	-10 AN	58510	58510B	58510F
60	-10 AN	68510	68510B	68510F
60	-12 AN	68512	68512B	68512F

Hose Barb 45° - Gold

Series	Size	FKM	Nitrile	EPDM
20	-4 AN	28504D	28504BD	28504FD
30	-4 AN	38504D	38504BD	38504FD
30	-6 AN	38506D	38506BD	38506FD
40	-6 AN	48506D	48506BD	48506FD
40	-8 AN	48508D	48508BD	48508FD
50	-8 AN	58508D	58508BD	58508FD
50	-10 AN	58510D	58510BD	58510FD
60	-10 AN	68510D	68510BD	68510FD
60	-12 AN	68512D	68512BD	68512FD

Hose Barb 90° - Gold

Series	Size	FKM	Nitrile	EPDM
20	-4 AN	28504E	28504BE	28504FE
30	-4 AN	38504E	38504BE	38504FE
30	-6 AN	38506E	38506BE	38506FE
40	-6 AN	48506E	48506BE	48506FE
40	-8 AN	48508E	48508BE	48508FE
50	-8 AN	58508E	58508BE	58508FE
50	-10 AN	58510E	58510BE	58510FE
60	-10 AN	68510E	68510BE	68510FE
60	-12 AN	68512E	68512BE	68512FE



TESTIMONIAL

“ I use Jiffy-tite fittings because they provide three important features: premium quality, large selection and most importantly, the fastest removal and replacement of critical components. When failures occur between rounds and seconds count, using Jiffy-tite fittings can make the difference between winning or losing. I rely on Jiffy-tite connections on all of my race cars because they work.” *Steve Williams*

All Pro-Compact sockets and plugs in the same series are interchangeable

Pro-Compact

SERIES

Sockets

Hose Barb

Hose Barb Straight - Black

Series	Size	FKM	Nitrile	EPDM
20	-4 AN	28504J	28504BJ	28504FJ
30	-4 AN	38504J	38504BJ	38504FJ
30	-6 AN	38506J	38506BJ	38506FJ
40	-6 AN	48506J	48506BJ	48506FJ
40	-8 AN	48508J	48508BJ	48508FJ
50	-8 AN	58508J	58508BJ	58508FJ
50	-10 AN	58510J	58510BJ	58510FJ
60	-10 AN	68510J	68510BJ	68510FJ
60	-12 AN	68512J	68512BJ	68512FJ

Hose Barb 45° - Black

Series	Size	FKM	Nitrile	EPDM
20	-4 AN	28504JD	28504BJD	28504FJD
30	-4 AN	38504JD	38504BJD	38504FJD
30	-6 AN	38506JD	38506BJD	38506FJD
40	-6 AN	48506JD	48506BJD	48506FJD
40	-8 AN	48508JD	48508BJD	48508FJD
50	-8 AN	58508JD	58508BJD	58508FJD
50	-10 AN	58510JD	58510BJD	58510FJD
60	-10 AN	68510JD	68510BJD	68510FJD
60	-12 AN	68512JD	68512BJD	68512FJD

Hose Barb 90° - Black

Series	Size	FKM	Nitrile	EPDM
20	-4 AN	28504JE	28504BJE	28504FJE
30	-4 AN	38504JE	38504BJE	38504FJE
30	-6 AN	38506JE	38506BJE	38506FJE
40	-6 AN	48506JE	48506BJE	48506FJE
40	-8 AN	48508JE	48508BJE	48508FJE
50	-8 AN	58508JE	58508BJE	58508FJE
50	-10 AN	58510JE	58510BJE	58510FJE
60	-10 AN	68510JE	68510BJE	68510FJE
60	-12 AN	68512JE	68512BJE	68512FJE



Pro-Compact

All Pro-Compact sockets and plugs in the same series are interchangeable

Push to Lock Hose Barb

Push to Lock Hose Barb Straight - Gold

Series	Size	FKM	Nitrile	EPDM
20	-4	28504P	28504BP	28504FP
30	-4	38504P	38504BP	38504FP
30	-6	38506P	38506BP	38506FP
40	-6	48506P	48506BP	48506FP
40	-8	48508P	48508BP	48508FP
50	-8	58508P	58508BP	58508FP
50	-10	58510P	58510BP	58510FP
60	-10	68510P	68510BP	68510FP
60	-12	68512P	68512BP	68512FP

Push to Lock Hose Barb 45° - Gold

Series	Size	FKM	Nitrile	EPDM
20	-4	28504PD	28504BPD	28504FPD
30	-4	38504PD	38504BPD	38504FPD
30	-6	38506PD	38506BPD	38506FPD
40	-6	48506PD	48506BPD	48506FPD
40	-8	48508PD	48508BPD	48508FPD
50	-8	58508PD	58508BPD	58508FPD
50	-10	58510PD	58510BPD	58510FPD
60	-10	68510PD	68510BPD	68510FPD
60	-12	68512PD	68512BPD	68512FPD

Push to Lock Hose Barb 90° - Gold

Series	Size	FKM	Nitrile	EPDM
20	-4	28504PE	28504BPE	28504FPE
30	-4	38504PE	38504BPE	38504FPE
30	-6	38506PE	38506BPE	38506FPE
40	-6	48506PE	48506BPE	48506FPE
40	-8	48508PE	48508BPE	48508FPE
50	-8	58508PE	58508BPE	58508FPE
50	-10	58510PE	58510BPE	58510FPE
60	-10	68510PE	68510BPE	68510FPE
60	-12	68512PE	68512BPE	68512FPE



TESTIMONIAL

“We use Jiffy-tite quick-connect fittings for our race trucks because when you are racing, time is of the essence. Jiffy-tite makes changes easy and quick with no leaks. Jiffy-tite simplifies our processes and provides us with added safety and leak-proof seals.” –*Team Renezeder*

All Pro-Compact sockets and plugs in the same series are interchangeable

Pro-Compact

SERIES

Sockets

Push to Lock Hose Barb

Push to Lock Hose Barb Straight - Black

Series	Size	FKM	Nitrile	EPDM
20	-4	28504PJ	28504BPJ	28504FPJ
30	-4	38504PJ	38504BPJ	38504FPJ
30	-6	38506PJ	38506BPJ	38506FPJ
40	-6	48506PJ	48506BPJ	48506FPJ
40	-8	48508PJ	48508BPJ	48508FPJ
50	-8	58508PJ	58508BPJ	58508FPJ
50	-10	58510PJ	58510BPJ	58510FPJ
60	-10	68510PJ	68510BPJ	68510FPJ
60	-12	68512PJ	68512BPJ	68512FPJ

Push to Lock Hose Barb 45° - Black

Series	Size	FKM	Nitrile	EPDM
20	-4	28504PJD	28504BPJD	28504FPJD
30	-4	38504PJD	38504BPJD	38504FPJD
30	-6	38506PJD	38506BPJD	38506FPJD
40	-6	48506PJD	48506BPJD	48506FPJD
40	-8	48508PJD	48508BPJD	48508FPJD
50	-8	58508PJD	58508BPJD	58508FPJD
50	-10	58510PJD	58510BPJD	58510FPJD
60	-10	68510PJD	68510BPJD	68510FPJD
60	-12	68512PJD	68512BPJD	68512FPJD

Push to Lock Hose Barb 90° - Black

Series	Size	FKM	Nitrile	EPDM
20	-4	28504PJE	28504BPJE	28504FPJE
30	-4	38504PJE	38504BPJE	38504FPJE
30	-6	38506PJE	38506BPJE	38506FPJE
40	-6	48506PJE	48506BPJE	48506FPJE
40	-8	48508PJE	48508BPJE	48508FPJE
50	-8	58508PJE	58508BPJE	58508FPJE
50	-10	58510PJE	58510BPJE	58510FPJE
60	-10	68510PJE	68510BPJE	68510FPJE
60	-12	68512PJE	68512BPJE	68512FPJE



Pro-Compact

All Pro-Compact sockets and plugs in the same series are interchangeable

Reusable Nut Hose End

Reusable Nut Hose End Straight - Gold

Series	Size	FKM	Nitrile	EPDM
20	-4 AN	28604	28604B	28604F
30	-4 AN	38604	38604B	38604F
30	-6 AN	38606	38606B	38606F
40	-6 AN	48606	48606B	48606F
40	-8 AN	48608	48608B	48608F
50	-8 AN	58608	58608B	58608F
50	-10 AN	58610	58610B	58610F
60	-10 AN	68610	68610B	68610F
60	-12 AN	68612	68612B	68612F
80	-12 AN	88612	88612B	88612F
80	-16 AN	88616	88616B	88616F
100	-16 AN	18616	18616B	18616F
100	-20 AN	18620	18620B	18620F



Reusable Nut Hose End 45° - Gold

Series	Size	FKM	Nitrile	EPDM
20	-4 AN	28604D	28604BD	28604FD
30	-4 AN	38604D	38604BD	38604FD
30	-6 AN	38606D	38606BD	38606FD
40	-6 AN	48606D	48606BD	48606FD
40	-8 AN	48608D	48608BD	48608FD
50	-8 AN	58608D	58608BD	58608FD
50	-10 AN	58610D	58610BD	58610FD
60	-10 AN	68610D	68610BD	68610FD
60	-12 AN	68612D	68612BD	68612FD
80	-12 AN	88612D	88612BD	88612FD
80	-16 AN	88616D	88616BD	88616FD
100	-16 AN	18616D	18616BD	18616FD
100	-20 AN	18620D	18620BD	18620FD



Reusable Nut Hose End 90° - Gold

Series	Size	FKM	Nitrile	EPDM
20	-4 AN	28604E	28604BE	28604FE
30	-4 AN	38604E	38604BE	38604FE
30	-6 AN	38606E	38606BE	38606FE
40	-6 AN	48606E	48606BE	48606FE
40	-8 AN	48608E	48608BE	48608FE
50	-8 AN	58608E	58608BE	58608FE
50	-10 AN	58610E	58610BE	58610FE
60	-10 AN	68610E	68610BE	68610FE
60	-12 AN	68612E	68612BE	68612FE
80	-12 AN	88612E	88612BE	88612FE
80	-16 AN	88616E	88616BE	88616FE
100	-16 AN	18616E	18616BE	18616FE
100	-20 AN	18620E	18620BE	18620FE



All Pro-Compact sockets and plugs in the same series are interchangeable

Pro-Compact

SERIES

Sockets

Reusable Nut Hose End

Reusable Nut Hose End Straight - Black

Series	Size	FKM	Nitrile	EPDM
20	-4 AN	28604J	28604BJ	28604FJ
30	-4 AN	38604J	38604BJ	38604FJ
30	-6 AN	38606J	38606BJ	38606FJ
40	-6 AN	48606J	48606BJ	48606FJ
40	-8 AN	48608J	48608BJ	48608FJ
50	-8 AN	58608J	58608BJ	58608FJ
50	-10 AN	58610J	58610BJ	58610FJ
60	-10 AN	68610J	68610BJ	68610FJ
60	-12 AN	68612J	68612BJ	68612FJ
80	-12 AN	88612J	88612BJ	88612FJ
80	-16 AN	88616J	88616BJ	88616FJ
100	-16 AN	18616J	18616BJ	18616FJ
100	-20 AN	18620J	18620BJ	18620FJ

Reusable Nut Hose End 45° - Black

Series	Size	FKM	Nitrile	EPDM
20	-4 AN	28604JD	28604BJD	28604FJD
30	-4 AN	38604JD	38604BJD	38604FJD
30	-6 AN	38606JD	38606BJD	38606FJD
40	-6 AN	48606JD	48606BJD	48606FJD
40	-8 AN	48608JD	48608BJD	48608FJD
50	-8 AN	58608JD	58608BJD	58608FJD
50	-10 AN	58610JD	58610BJD	58610FJD
60	-10 AN	68610JD	68610BJD	68610FJD
60	-12 AN	68612JD	68612BJD	68612FJD
80	-12 AN	88612JD	88612BJD	88612FJD
80	-16 AN	88616JD	88616BJD	88616FJD
100	-16 AN	18616JD	18616BJD	18616FJD
100	-20 AN	18620JD	18620BJD	18620FJD

Reusable Nut Hose End 90° - Black

Series	Size	FKM	Nitrile	EPDM
20	-4 AN	28604JE	28604BJE	28604FJE
30	-4 AN	38604JE	38604BJE	38604FJE
30	-6 AN	38606JE	38606BJE	38606FJE
40	-6 AN	48606JE	48606BJE	48606FJE
40	-8 AN	48608JE	48608BJE	48608FJE
50	-8 AN	58608JE	58608BJE	58608FJE
50	-10 AN	58610JE	58610BJE	58610FJE
60	-10 AN	68610JE	68610BJE	68610FJE
60	-12 AN	68612JE	68612BJE	68612FJE
80	-12 AN	88612JE	88612BJE	88612FJE
80	-16 AN	88616JE	88616BJE	88616FJE
100	-16 AN	18616JE	18616BJE	18616FJE
100	-20 AN	18620JE	18620BJE	18620FJE



O-Ring Boss

Male O-Ring Boss Straight

Series	Size	FKM	Nitrile	EPDM
20	-4	29104	29104B	29104F
30	-4	39104	39104B	39104F
30	-6	39106	39106B	39106F
40	-6	49106	49106B	49106F
40	-8	49108	49108B	49108F
50	-8	59108	59108B	59108F
50	-10	59110	59110B	59110F
60	-10	69110	69110B	69110F
60	-12	69112	69112B	69112F

Male O-Ring Boss - 45°

Series	Size	FKM	Nitrile	EPDM
20	-4	29104D	29104BD	29104FD
30	-4	39104D	39104BD	39104FD
30	-6	39106D	39106BD	39106FD
40	-6	49106D	49106BD	49106FD
40	-8	49108D	49108BD	49108FD
50	-8	59108D	59108BD	59108FD
50	-10	59110D	59110BD	59110FD
60	-10	69110D	69110BD	69110FD
60	-12	69112D	69112BD	69112FD

Male O-Ring Boss - 90°

Series	Size	FKM	Nitrile	EPDM
20	-4	29104E	29104BE	29104FE
30	-4	39104E	39104BE	39104FE
30	-6	39106E	39106BE	39106FE
40	-6	49106E	49106BE	49106FE
40	-8	49108E	49108BE	49108FE
50	-8	59108E	59108BE	59108FE
50	-10	59110E	59110BE	59110FE
60	-10	69110E	69110BE	69110FE
60	-12	69112E	69112BE	69112FE

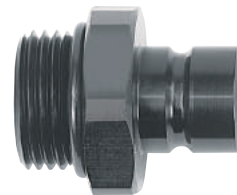

TECH TIP

Jiffy-tite Quick-Connect Fittings will work with most steel-braided, lightweight black and push-to-lock hose styles, except PTFE.

All Pro-Compact sockets and plugs in the same series are interchangeable

Pro-Compact

SERIES
Plugs

Female 37° AN

Female 37° AN Straight

Series	Size	Part Number
20	-4 AN	29304
30	-4 AN	39304
30	-6 AN	39306
40	-6 AN	49306
40	-8 AN	49308
50	-8 AN	59308
50	-10 AN	59310
60	-10 AN	69310
60	-12 AN	69312
80	-12 AN	89312
80	-16 AN	89316
100	-16 AN	19316
100	-20 AN	19320

Female 37° AN 45 Degree - Swivel

Series	Size	Part Number
20	-4 AN	29304D
30	-4 AN	39304D
30	-6 AN	39306D
40	-6 AN	49306D
40	-8 AN	49308D
50	-8 AN	59308D
50	-10 AN	59310D
60	-10 AN	69310D
60	-12 AN	69312D
80	-12 AN	89312D
80	-16 AN	89316D
100	-16 AN	19316D
100	-20 AN	19320D

Female 37° AN 90 Degree - Swivel

Series	Size	Part Number
20	-4 AN	29304E
30	-4 AN	39304E
30	-6 AN	39306E
40	-6 AN	49306E
40	-8 AN	49308E
50	-8 AN	59308E
50	-10 AN	59310E
60	-10 AN	69310E
60	-12 AN	69312E
80	-12 AN	89312E
80	-16 AN	89316E
100	-16 AN	19316E
100	-20 AN	19320E



Male 37° AN

Male 37° AN Straight

Series	Size	Part Number
20	-4 AN	29404
30	-4 AN	39404
30	-6 AN	39406
40	-6 AN	49406
40	-8 AN	49408
50	-8 AN	59408
50	-10 AN	59410
60	-10 AN	69410
60	-12 AN	69412
80	-12 AN	89412
80	-16 AN	89416
100	-16 AN	19416
100	-20 AN	19420



Male 37° AN 45 Degree

Series	Size	Part Number
20	-4 AN	29404D
30	-4 AN	39404D
30	-6 AN	39406D
40	-6 AN	49406D
40	-8 AN	49408D
50	-8 AN	59408D
50	-10 AN	59410D
60	-10 AN	69410D
60	-12 AN	69412D
80	-12 AN	89412D
80	-16 AN	89416D
100	-16 AN	19416D
100	-20 AN	19420D



Male 37° AN 90 Degree

Series	Size	Part Number
20	-4 AN	29404E
30	-4 AN	39404E
30	-6 AN	39406E
40	-6 AN	49406E
40	-8 AN	49408E
50	-8 AN	59408E
50	-10 AN	59410E
60	-10 AN	69410E
60	-12 AN	69412E
80	-12 AN	89412E
80	-16 AN	89416E
100	-16 AN	19416E
100	-20 AN	19420E



All Pro-Compact sockets and plugs in the same series are interchangeable

Pro-Compact

SERIES
Plugs

Male NPT

Male NPT Straight

Series	Size	Part Number
20	1/8"	29802
20	1/4"	29804
30	1/4"	39804
30	3/8"	39806
40	3/8"	49806
40	1/2"	49808
50	1/2"	59808
60	3/4"	69812
80	3/4"	89812
80	1"	89816

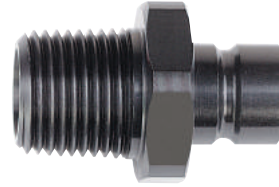

Male NPT 45°

Series	Size	Part Number
20	1/8"	29802D
20	1/4"	29804D
30	1/4"	39804D
30	3/8"	39806D
40	3/8"	49806D
40	1/2"	49808D
50	1/2"	59808D
60	3/4"	69812D
80	3/4"	89812D
80	1"	89816D



Male NPT 90°

Series	Size	Part Number
20	1/8"	29802E
20	1/4"	29804E
30	1/4"	39804E
30	3/8"	39806E
40	3/8"	49806E
40	1/2"	49808E
50	1/2"	59808E
60	3/4"	69812E
80	3/4"	89812E
80	1"	89816E



TESTIMONIAL

"The JDM Group use's Jiffy-tite fittings on all our SCCA championship winning cars. From the 2000 series connectors for the mandated fuel test ports to the 5000 series on our oil cooler and water lines for quick engine swaps, you cannot beat the quality, cost effectiveness and time savings of Jiffy-tite products!" **-Bob Clark** Driver and Crew Chief, JDM Group. 2006, 2007, 2009, 2013 SCCA GTL National Champions

JIFFY-TITE'S TOP 10 FREQUENTLY ASKED QUESTIONS...

1. Where can I buy Jiffy-tite Quick-Connect Fluid Fittings?

To find a shop near you just go to www.jiffy-titemotorsports.com and click on the "Distributors" tab at the top of the page. Don't see a shop near you? Don't worry! Many of our distributors also sell online, or you can always call us to help you: 888-605-7788.

2. Will these fittings work for a diesel engine?

Jiffy-tite fittings will work with diesel fuel as long as the correct seal material is used. When running diesel fuel, be sure to choose Fluorocarbon (FKM) seals for fluid compatibility. See page 4 for the complete seal compatibility chart.

3. What is the difference between valved and non-valved?

The difference between our valved and non-valved parts is all internal. The valved plug and socket will stop fluid from leaking out of the connectors when disconnected. Our non-valved plug and socket are 100% flow through.

4. Are all sockets and plugs within the same series interchangeable?

Yes, all sockets and plugs within the same series are interchangeable. For example, any 2000 series socket is compatible with any 2000 series plug. You CANNOT use a different series socket and plug.



5. Are Jiffy-tite Quick-Connect fittings acceptable for use in SCCA?

Yes, Jiffy-tite Quick-Connect fittings are SCCA accepted. They are also the only quick-connects on the market that are approved by the National Hot Rod Association, International Hot Rod Association, National Auto Sport Association, as well as many other sanctioning bodies.

6. Will Jiffy-tite Quick-Connect fittings work on brake applications?

Jiffy-tite Quick-Connect fittings are designed to be used in virtually any water, oil, fuel or transmission application. That being said, no, Jiffy-tite does not recommend that our products be used on brakes because of the high pressure situation. Our fittings are rated for maximum operating pressure of 200 PSI.

7. Can I use your connectors for vacuum lines? And will a valved connector stay closed when negative pressure is drawn while disconnected?

Yes, Jiffy-tite connectors can be used on vacuum lines; however we recommend the use of a non-valved connector for this application. Whether or not they remain closed will all depend on how much negative pressure you are pulling.

8. When disconnected, is flow from both directions stopped?

Jiffy-tite's valved Quick-Connect fittings are designed to stop fluid flow in both directions when disconnected. Please be aware though that unlike a "dry brake" fitting, two or three drops of fluid may be lost when disconnecting; especially when under pressure.

9. What style of hose can I use with Jiffy-tite fittings?

Jiffy-tite Quick-Connect fittings will work with most steel braided and cloth braided hoses on the market today, as well as push to lock hose.

10. I want to make removal of my clutch easier; will your product work for a hydraulic throwout bearing?

Depending on the pressure, yes, Jiffy-tite Connectors can be used. Our Quick-Connect fittings are rated up to 200psi. Also, if the fluid that is in your hydraulic clutch is brake fluid, you will need to order these connectors with our EPDM seals. The complete seal compatibility chart is on page 4.

PLANOGRAM- P/N 70001

The Planogram consists of 1 header card, 10 slat/peg hooks and instructions with re-order cards.

Dimensions of header card: 24" x 12"

The following part numbers & quantities are included:

Note: Sockets come standard in black & gold, sockets are also available in **Stealth Black**



Part Numbers	QTY	Descriptions
21606	2	2000 Series Socket, -6 AN Reusable Nut Hose End- Valved
21406	2	2000 Series Socket, -6 AN 37° Male- Valved
21506	2	2000 Series Socket, -6 AN Hose Barb- Valved
22506	2	2000 Series Plug, -6 AN Hose Barb- Valved
22406	2	2000 Series Plug, -6 AN 37° Male- Valved
31406	2	3000 Series Socket, -6 AN 37° Male- Valved
31408	2	3000 Series Socket, -8 AN 37° Male- Valved
31608	2	3000 Series Socket, -8 AN Reusable Nut Hose End- Valved
32306	2	3000 Series Plug, -6 AN 37° Female- Valved
32408	2	3000 Series Plug, -8 AN 37° Male- Valved
200T1	1	-6 AN Transmission Kit includes 2 reducers, (1/4" NPT to 1/8" NPT), 2 steel braided hose, 1 plug, 1 socket

PROMOTIONAL ITEMS

HATS

AVAILABLE IN BLACK OR CAMO	Black	MSP0001
	Camo	MSP0002

T-SHIRTS

AVAILABLE IN SIZE SMALL, MEDIUM, LARGE, XL, 2 XL, 3 XL	Small	MSP0003
	Medium	MSP0004
	Large	MSP0005
	XL	MSP0006
	2 XL	MSP0007
	3 XL	MSP0008

DECALS

AVAILABLE IN BLACK SIZE 5" CIRCULAR	Black	MSP0025
-------------------------------------	-------	---------

KOOZIES

AVAILABLE IN BLACK OR RED	Black	MSP0026
	Red	MSP0027





Our Mission is to ensure our company's long-term success by thoroughly delighting our customers with quality, innovative and continually improving solutions that are second to none.

We will achieve this mission with harmonious teamwork among employees, customers, and suppliers.

The achievement of our mission will be determined by our customers' success through using our products and services and the degree to which the company, employees and suppliers are enriched.

Jiffy-tite Company, Inc. Motorsports Disclaimer

Jiffy-tite Co., Inc. disclaims all warranties, expressed or implied, oral or written, to the purchaser or any other person, including without limitation any implied warranties of merchantability or fitness for a particular purpose, except to the extent that any warranties implied by law cannot be waived. Under no circumstances shall Jiffy-tite be liable to you or any other person for special, incidental, consequential, direct or indirect damages, loss or injury arising from the use of its products. Racing is a dangerous activity. The user shall determine the suitability and safety of the product for its intended use, and the user assumes all responsibility and risk in connection therewith.

Jiffy-tite® is a registered trademark of Jiffy-tite Company, Inc. and Copyright 2014 All rights reserved

