



ENERGY
MANUFACTURING



Performance Engine Components by Callies



2021



***If you are serious about being in the winner's circle,
then you have to be serious about Callies.***

Callies Performance Products began manufacturing high performance crankshafts in 1989. With many years of engineering and employee experience, we have grown to be the industry leader for innovative product design. This, along with our sister company, Energy Manufacturing, and our partnerships with various suppliers, Callies is truly your one stop shop for performance.

We take pride in staying ahead of the competition with the latest high tech design and manufacturing advantages. Utilizing the latest in computer aided solid modeling and CNC machining centers, Callies offers the best designed, highest quality crankshafts, connecting rods, and camshafts available on the market today.

At the heart of our commitment to excellence is one of the most experienced sales teams in the industry. Up-to-date information on the latest products and innovations is available to Callies customers through our expert sales staff. Information shared between Sales, Engineering and Manufacturing personnel on a daily basis creates company-wide continuity ensuring that Callies maintains a focus on developing performance products that exceeds all of your needs.



ENERGY

MANUFACTURING

Energy Manufacturing, Ltd. was formed in 2009 and is a distinctive expansion of Callies Performance Products and Tecnomia Industries.

ENERGY is focused on precision machining and manufacturing for complex components and assemblies where partners need custom solutions or that have a specialized or demanding routine. This includes applications for the high performance racing market, defense, mining, and oil and gas sectors.

A state-of-the-art manufacturing facility and in-house design team means that ENERGY is suited to scale production to meet a large spectrum of volume and complexity. With billet aluminum engine blocks, intake manifolds, cylinder heads and various other accessories, ENERGY has the recipe for performance.

www.energymanufacturing.com | 419-355-9304



* All HP ratings are for reference only. * Other part numbers may be available. Contact our sales department for availability.

Table of Contents

Crankshafts

Ultra Billet.....	2
Ultra Dirt & Boost	3
Magnum Billet.....	4
Magnum XL.....	5
Magnum.....	6
Compstar	7
Sport Series.....	34-42

Connecting Rods

Ultra & Ultra Enforcer Rods..	8-10
Compstar	11
Rod Part #'s	49-50

Crankshafts by Engine Family

LS	14-16
Big Block Chevy	17-19
Small Block Chevy	20-24
Ford 460	25
Ford 351/302	26-27
Coyote	28
RY45	29
Viper V-10	29
Mopar/Gen III Hemi	30-31
Diesel	32

Nissan GT-R	33
Sport Series	34-42

Camshafts

Fully Finished Camshafts	12
Carbocore and Indurocore....	13

Allied Components

Billet Blocks by Energy....	44-46
Intake Manifolds by Energy...	46
Cylinder Heads by Energy	47
Heavy Metal.....	48
Supporting Mfgs.....	48

ULTRA BILLET CRANKSHAFTS



Callies Ultra Billets are intended for use in cutting edge applications where durability and innovation are a must. Ultra billets are produced from low carbon-high nickel steel that receives multiple heat treatments. Our specialty steel and heat treat processing yields a crankshaft with fracture resisting ductility, stiffness and a wear-resistant outer case.

Your Ultra billet can be ordered in many custom configurations. These high alloy crankshafts are intended for severe duty, high output applications.

Ultra Billets Are Manufactured For The Following Engine Families:

- **Small Block Chevy**
4.400", 4.500" and 4.600" Bore Spacing
- **Big Block Chevy**
4.840", 4.900", 5.000", 5.300" Bore Spacing
- **LSx Cleveland Mains, all types, LT1**
- **SB Ford 302 and 351**
- **BB Ford 460**
- **Mopar Hemi - 440**
- **Gen III Hemi**
- **RY45**
- **Nissan GT-R**
- **Duramax**
- **RB30 Hybrid**
- **Noonan**
- **Miner**
- **481X**

Each Ultra billet crankshaft is uniquely machined with our Ultra-Shed counterweight profiles. The Ultra-Shed leading edge profile gently moves oil away from the oncoming counterweight while the directional trailing edge directs oil away from the oncoming rod journal.

Our Aero-Shed super finish will give you a totally stress-riser free and incredibly aero efficient crankshaft. When the Ultra-Shed and Aero-Shed processes are combined, the result is a crankshaft with the lowest coefficient of drag in the industry.



Optional center counterweight shown with Ultra-Shed leading and trailing edge contouring



Rod journal holes and main bearing gun drill bores are all highly polished and radiused.



Top Fuel Hemi with Aero-Shed super finish and splined post

ULTRA DIRT / BOOST CRANKSHAFTS



Ultra Dirt Billet cranks are application specific designed billet cranks made from Callies proprietary TimkenSteel 4330. Specifically designed for circle track applications where the absolute minimum reciprocating weight is demanded without sacrificing strength. Torsional fatigue is mitigated through strength enhancing pin arms. Counterweights are reduced in radial width to reduce weight but at the same time not sacrificing balance characteristics.



Ultra-Boost Series Billet cranks are power adder specifically designed. These are made from Callies proprietary TimkenSteel 4330. Pin arms mimic our industry leading design proven in Top Fuel racing. Extra material is added also to the front and rear arms where loads are targeted and normally cause failures. Torrington bearing provisions are available upon request.

MAGNUM BILLET CRANKSHAFTS

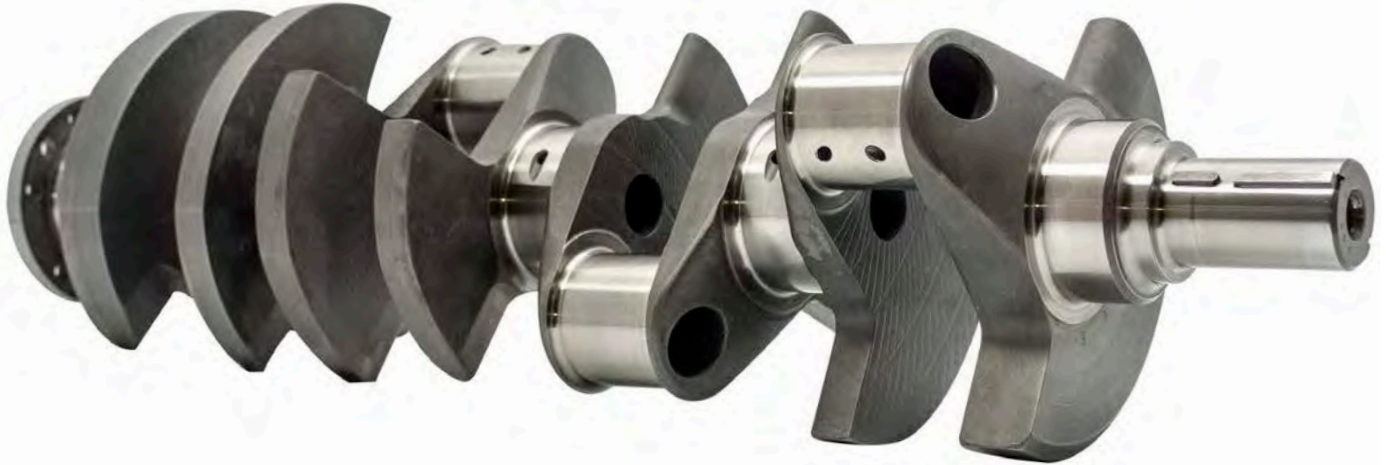

The best features of crankshaft design are incorporated into each **Magnum Billet Crankshaft**. Drawing from years of crankshaft experience, the Callies design team created a lightweight, eight counterweight crankshaft. This design criteria has been followed for each family of shafts found in the Magnum Billet line of products.

To guarantee consistency, every Magnum Billet is produced from high grade American made 4340 steel that is completely heat treated and nitride surface hardened in house at Callies. A wide range of strokes and journal combinations are available. A typical eight counterweight Magnum Billet Small Block Chevy crankshaft will weigh less than 48 pounds.

Special attention given to counterweight placement has resulted in shafts that minimize the need for heavy metal.

Magnum Billets Are Manufactured For The Following Engine Families:

- **Small Block Chevy**
4.400" and 4.500" Bore Spacing
- **Big Block Chevy**
4.840" Bore Spacing
- **BB Ford 460**
- **BB Mopar**
- **DuraMag**



MAGNUM XL / XB CRANKSHAFTS



For nearly 20 years, **Magnum XL crankshafts** have proven to be the most durable, best performing lightweight crankshafts available. Machined from ultra pure SAE 4340 steel, these lightweight crankshafts are capable of handling the high horsepower and RPM of today's most advanced engines.

Magnum XL lightening profiles result in crankshafts having extremely high strength to weight ratios. Material is carefully removed from non-stressed areas of each shaft eliminating parasitic material and weight. The Callies Magnum XL profile is exceptionally effective at minimizing windage within the crankcase atmosphere. Oil control is improved through the elimination of disruptive undercuts, resulting in smooth sided, free flowing counterweights. Each main and rod journal is drilled for weight reduction and throttle response improvement.

Magnum XL crankshafts are shipped fully balanced to your exact assembly weight without drilling. These crankshafts are available in many custom configurations. Your order will be processed specifically to meet your needs.

Our unique Magnum XL lightening profiles were developed to optimize material distribution for enhanced strength, superior bearing load reduction, and consistent balance.

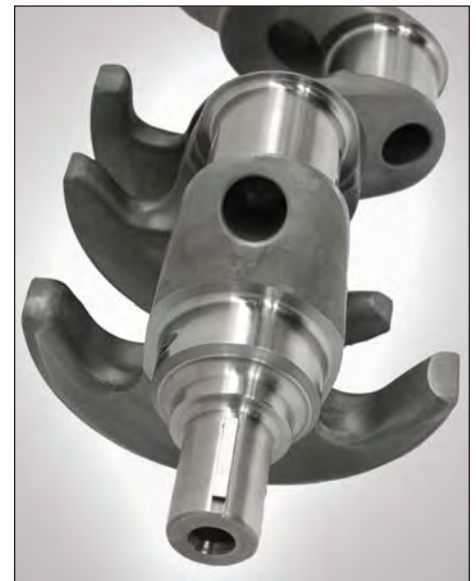

Small Block Chevy Magnum XL profiling close-up



Big Block Chevy, up to 4.500". Subject to stroke/bob weight combinations.

Magnum XL Are Available For The Following Engine Families:

- Small Block Chevy
- Big Block Chevy
- LSx/Gen V LT1
- Small Block Ford 302 and 351

MAGNUM CRANKSHAFTS



After years of service, **Magnum crankshafts** by Callies have established themselves as one of the most durable competition crankshafts ever produced. Magnum crankshafts are manufactured from ultra pure SAE 4340 steel. Callies then subjects this material to multiple heat treatments, resulting in a crankshaft with unsurpassed wear and strength characteristics. All Magnum cranks feature Callies Ultra-Case heat treatment.

Magnum Are Available For The Following Engine Families:

- LSx/Gen V LT1
- Small Block Chevy
- Big Block Chevy
- Small Block Ford 302, 351
- Big Block Ford 460
- Duramax

Each Magnum crank will have gun drilled mains and fully profiled counterweights, regardless of engine type. A typical 4.000" stroke Small Block Chevy will weigh less than 48 pounds. Magnum crankshafts are available for a variety of engine types and can be manufactured to your specific configuration.

Many crankshafts are counterweighted to offset simple balance forces detected at main bearings 1 and 5 by today's precision balancers. Callies Magnum Mass Correct counterweights have been strategically placed to reduce imbalance forces over the entire length of the shaft. The result is a crankshaft exhibiting superior bearing life and minimal wear.

Material distribution over the rod journal arms and critical strength generating regions of Magnum crankshafts has been enhanced as well. These slight design changes improve the strength to weight ratio, ensuring each Magnum crankshaft will have an extended fatigue resistant life.



COMPSTAR COMPONENTS



Compstar components were introduced in 2004 as a product line designed to meet and exceed the requirements of today's racer at a sensible price point. Callies' value driven approach is to design and engineer here in the U.S., then source through long term vendors, supported by our engineers, giving us distinct technical and quality advantages. This coupled with our American craftsmen, that finish the components at our facility in Fostoria, Ohio, create a combination that is considerably more robust and stable than our competitors. We are not just an importer of product, we are a manufacturer that wants to bring products to our customers at all price points.

Our Compstar line also extends to Sport Series, which we have designed for Maximum Effort engines. They feature the best metallurgy and heat treatment on the market today.

Compstar Step by Step:

1. Compstar crankshafts begin their life overseas where they are forged using Callies owned dies. Not generic forging that other manufacturers use. You can be confident that you're getting our product by the triangle shaped notch in one of the counterweights.
2. The 4340 steel forgings are semi-finished, machined off-shore, then shipped to Callies to be finished.
3. All Compstar components are 100% Mag Particle inspected to verify there are no cracks or inclusions in the material. Additionally, our in house metallurgical laboratory verifies material and heat treatment to ensure it meets Callies engineering and quality requirements.
4. 100% of our Compstar crankshafts are finish sized and polished by American craftsmen, ensuring proper fitment and widths. Additional items checked are runout, bolt holes and oil holes.
5. Every crank then goes through our stringent Quality Control final check, guaranteeing your Compstar Engine Component is ready to race.

ULTRA CONNECTING ROD



ULTRA™

Callies has developed the **Ultra connecting rod** with the design goal of an uncompromised strength to weight ratio. Every Ultra connecting rod is produced from specially formulated TimkenSteel 4330 and precision forged for uniform grain flow and consistency. Many geometric nuances are incorporated into the design of Ultra connecting rods, which are subject to high output, high RPM applications. These design features enhance the Ultra against specific loads and stresses.

Ultra connecting rods are fastened by high alloy cap screws produced specifically for severe applications by ARP. Purpose built 260Ksi Ultra Bolts offer improved thread engagement for a smoother, more consistent net clamping load. To eliminate deformation and extrusion only Ampco 45 bronze silica alloy is used within the wrist pin housing bore. This material has a proven hardness more than 26% greater than commonly used Ampco 18 material. For high RPM or extreme horsepower applications, Ultra connecting rods are fitted with MP 3.5 bolts. These Ultra high alloy fasteners provide unparalleled clamping strength and toughness. Upgraded bolts are available for all Ultra I-Beam connecting rod configurations.

ULTRA ENFORCER



Designed with fortified tower flanges, **Enforcer I-beam** connecting rods are the ideal component for turbocharged and supercharged engines.

The I-beam design has been time tested and proven as the most stable configuration in high torque applications. High combustion forces generated within boosted engines are capable of buckling a standard connecting rod that had been intended for a naturally aspirated application.

ULTRA CONNECTING ROD

Ultra & Ultra Enforcer Connecting Rod Design Features

1. Truncated arc tower flanges improve stiffness and reduce weight.
2. Smooth notch free section at bearing housing shoulder.
3. Pressure Angle Arches disperse wrist pin induced strain.
4. Large web to flange transition radius.
5. Full fillet intersection of bolt spot face and interior gusset surfaces.
6. Stress spreading (twin rib caps) utilize the extended section concept of strength enhancement.
7. Precisely machined (Trapezoidal Contour) at the tower base eliminating parallel flange harmonics and increasing weight reduction.
8. Extended foot print at joint mating faces for superior housing stability.
9. Min/Max gusset; our analyzed design minimizes material yet achieves maximum stiffness.
10. Low carbon, high-alloy Timken specialty steel.

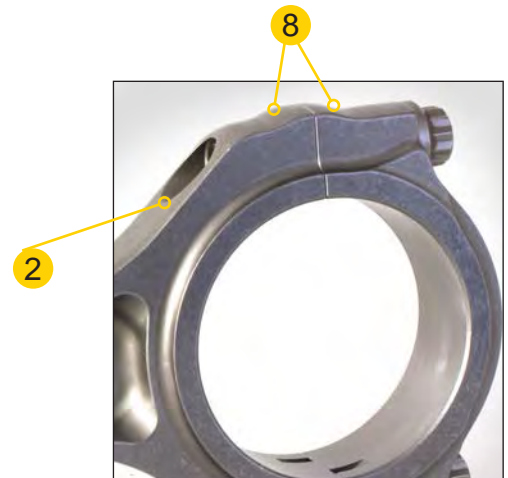
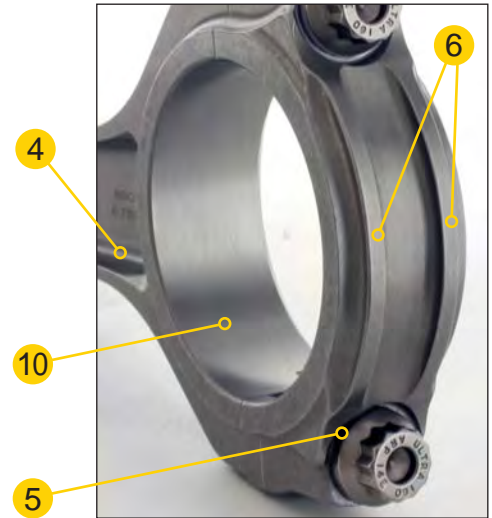

ULTRA ASSASSIN



Ultra Assassin diesel rods are made entirely in the USA. Like all Ultra rods they are made from specially formulated TimkenSteel 4330V. This material is then precision forged in Michigan and machined in our Fostoria, Ohio facility. Assassin Series Rods are near net as forged with minimal machining. They are fastened by high alloy cap screws made specifically for severe duty service by ARP Inc. To eliminate deformation and extrusion only AMS 642 bronze alloy is used within the wrist pin housing bore.

ULTRA CONNECTING ROD

ULTRA

Dirt / Oval Track Rods



Designed for naturally aspirated motors the Ultra Dirt / Oval rods feature a tapered beam. This reduces the overall mass which in turn means a lighter bob weight and quicker throttle response. They also incorporate an enhanced big end where 7/16 bolts are utilized on the Honda rod journal. Thus increasing clamping loads without the added expense required when using the small 3/8 fasteners. The Ultra Dirt / Oval rods are made from the same TimkenSteel 4330 V steel and 265 KSI Ultra bolts as any other rod in the Ultra family. These are also available with the ARP MP3.5 Bolts and .866 Wrist pins.

ULTRA XD

This unique connecting rod design offers greater cam to connecting rod clearance. This innovation will allow the use of increased base circle cams for improved valve train performance, stability, and horsepower. For the first time, engine builders are given greater flexibility in selecting valve train components when using a standard cam height block. The Ultra XD concept has been track tested and proven to be a reliable, long term solution to troublesome connecting rod to camshaft interference problems.

Additional XD Clearance

Unique canted housing bore design provides at least 0.050" of additional cam clearance

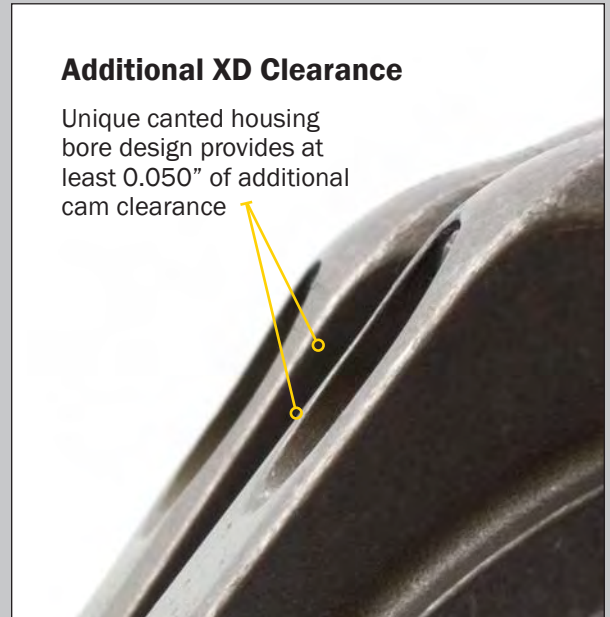

Ultra H-Beam connecting rods are High Value American-made engine components. Ultra H-Beams are forged from the same premium 4330 material as our entire Ultra line. Savings resulting from streamlined manufacturing design are passed directly on to you. The Ultra H design ensures the geometry of these critical components will remain true under high tensile and compressive load situations.



ULTRA
(High Value) H-Beam
Connecting Rods

COMPSTAR CONNECTING ROD



Compstar Connecting Rods are given the same attention to detail as our Compstar Crankshafts. Although they begin their journey overseas, they are forged on Callies own dies and are returned to our shop in Fostoria, Ohio to be finished. Every detail of this highly-stressed component has been carefully analyzed to maximize repeatability and dependability.

Compstar rods were designed with higher horsepower stroker motors in mind from the start, not as an afterthought. Bolt upgrades and stroker clearance are normally additional cost options with other rods, but are standard equipment with Compstar rods.

ARP 2000 bolts are used exclusively for superior tensile strength and clamping force at the critical mating joint of the rod and cap. The placement of these bolts is also key to additional rotational clearance in stroker applications at the bottom of the bores and at the pan rails.

Strengthening gussets are also added to the bolt spot-face area of the cap where cross sectional thickness is at a minimum. These gussets not only increase strength, but aid in dimensional stability as well.

Contouring above the bolts increase cam clearance and decrease the amount of clearance required at the bottom of the bores on the cam side.

The increasingly popular Forged Side Relief style pistons move the pin bosses inward, normally requiring narrowing of the pin end of the connecting rod. Compstar rods are designed and manufactured with a .960" pin end width, and will work with all currently available FSR style pistons without modification.

Compstar Rods Step by Step:

1. Compstar and Compstar Sport Series are forged overseas on Callies owned dies. They are not run on the community dies shared by many others.
2. The 4340 steel forgings are semi-machined off-shore and then shipped to Callies to be finished.
3. Metallurgical checks confirm the material and heat treatment complies with our specifications.
4. 100% of the parts are washed, Callies purchased ARP fasteners are installed and torqued, and parts are honed by our American craftsmen to final sizes.
5. Samples from each lot are checked in our Quality Control lab for adherence to our strict specifications, and also checked for bend and twist. Parts are weight matched into sets creating consistency for the engine builder.

CAMSHAFTS / CAM CORES

Callies Performance Products has developed one of the most extensive camshaft machining capabilities in North America. In addition to our comprehensive in house heat treat department we are able to produce and verify any complex contour found on today's camshafts.

Callies fully finished camshafts are machined and heat treated entirely in house. This continuity of manufacturing allows Callies to deliver high quality camshafts on schedule. Our finished cams are ground with the latest Landis CNC technology and ADCOLE inspected for accuracy making them the most consistent cams on the market today. If required, your cams can be finished with inverted flank lobe profiles and complex VVT oil channels and drillings.



Callies Cam Research Lab

Valvetrain durability is a key ingredient to the success of every engine. The Callies Cam Research Lab has been established to guarantee that our cams are capable of extended life cycles in abusive applications. When combined with our metallurgical capabilities, the Callies Cam Research Lab allows evaluation of lobe profiles, valvetrain systems and processing methods like no other cam company. Spintron testing enables our engineering staff to evaluate valvetrain stability in minute detail up to 11,000 RPM. Programmable test cycles allow complete event simulation. Sixteen channel data acquisition can provide monitoring of temperatures, pressures, flows, loads and strain. Let Callies help you design your next step forward.

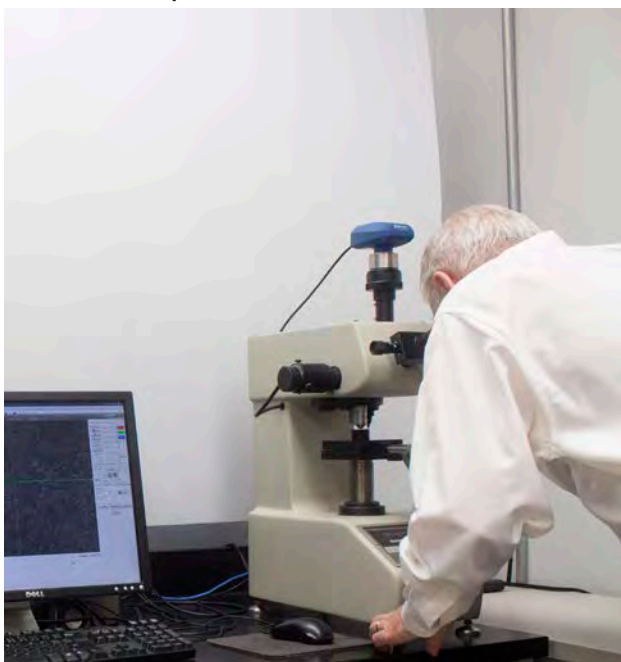

Micro hardness testing on Leco LM100AT



Spintron test rig with laser tracking system

CAMSHAFTS / CAM CORES

CARBOCORE

PERFORMANCE CAMSHAFT CORES

Carburized & Hardened 8620 and 9310 steel camshaft cores are produced to AMS 2301 (AQ) standards. Our engineering staff can create an unground lobe profile to your exact requirement. Carbocore cams are machined and heat treated entirely in house.

Callies Indurocore camshaft cores can be machined to your specification from either 1050 or 4150 alloy steel. Every Indurocore cam is induction hardened in house at Callies. This process is carefully monitored guaranteeing metallurgical consistency. Indurocore cams are available for a wide range of engines.

TITAN
Tool Steel Camshafts

Callies metallurgy and heat treat teams have perfected a revolutionary process that offers unrivaled camshaft durability. Titan Tool Steel Camshafts give you more options for performance enhancing geometry while increasing life expectancy. Fully finished Titan cams are available for a wide range of engines and applications.



INDUROCORE

PERFORMANCE CAMSHAFT CORES

Engine Families Presently Supported:
(Cores or Finish Ground)

- Ford Powerstroke
- Cummins B series
- LS Std, 55mm, 60 mm
- SBC all bore spacings
- BBC all bore spacings
- Gen III Hemi
- LS1
- Mopar T/F & T/A, 6 bolt
- Pontiac V8
- Holden V8
- Mopar R block
- Dodge Viper
- Duramax
- Ford 351 / 302
- Ford 429 / 460



Jenoptik Opticline inspection machine



Multiple Landis CNC cam grinders

LSx & GEN V LT1

Callies has developed a wide range of part numbers for the continually evolving and popular LS family of engines. You will find our selection of components to be the industry's most comprehensive offering.



Ultra LS cranks can be purchased with or without large fan angle center counterweights

LS Ultra Billet

Available Options:

- Stroke range of 2.720" to 4.600"
- LS1, LS7, LT1 posts are available
- 6, 8, or 9 bolt pattern flange options
- Rod Sizes: 1.850", 1.888", 2.000", 2.100", (2.200" w/sbc width) 2.200"
- Main Journal Sizes: Standard LS, Iron Duke, Ford Cleveland 351
- 8 or 6 counterweight designs available
- Sold complete with no drill balance
- Aero efficient Ultra-Shed counterweight profiling is standard
- Aeroshed super finishing included with all Ultra billets
- All Ultra LS billets are produced from Timken 4330 alloy steel

Contact the Callies sales team for a full list of part numbers and options. 419-435-2711

LS/Gen V LT1 8 Counterweight Magnum

Average weight: 52 lbs.

LS1 Gen III - IV Standard Features

- Stroke range of 2.720" to 4.250"
- Fully counterweighted
- Counterweight prepped for a minimum 1830g bob weight
- Dual linear post keyways
- Average weight 47 lb.
- Gun drilled mains & lightened rods
- Additional post keyways available
- Custom flange bolt and dowel drilling available
- 2.100", 2.000", 1.888", 1.850" rod journal diameters
- LS, LS7, or LT1 posts configurations
- Custom reluctor hub machining or removal
- Chevy 283 and Ford 351 mains available as custom



- 6 Counterweight Magnum also available.
- Contact the Callies sales team for a full list of part numbers and options.



6 Counterweight DragonSlayer

Average weight: 48.5 lbs.

Standard Features

- Average weight 50 lb.
- 6 Counterweight Design
- Limited Stroke Availability: 4.125", 4.100, 4.000", and 3.625"
- LS or LS7 post configurations
- Dual linear post keyways
- Counterweight prepped for an 1830 g bob weight
- Standard LS mains, 2.100" rod journals
- Gun drilled mains and lightened rods

Stroke:	Main:	Pin:	Cammed for Rod Length	Part #:
3.625	2.559	2.100	6.100	APH31T-DS
4.000	2.559	2.000	6.125	APO34T-DS
4.000	2.559	2.100	6.125 LS7 Post	AWO31T-DS

LSx & GEN V LT1



Compstar LSx (6 and 8 Counterweight)

Standard Features

- Typical weight for a 4.000" stroke, 2.100" journal = 51 lbs.
- 2.100" or 2.000" rod journals
- Standard LS main diameters only
- 3.625", 4.000", 4.100", 4.125" strokes available
- All Compstar LS cranks are counterweight prepped to 1825 gram bob weight
- OEM 58 tooth reluctor or billet 24 tooth reluctors available

Compstar LSx 6 Counterweight

Stroke:	Main:	Pin:	Cammed for Rod Length	Part #:	Stroke:	Main:	Pin:	Cammed for Rod Length	Part #:
3.625	2.559	2.100	6.125	APH317-CS24	4.000	2.559	2.000	6.125	APO34N-CS
3.625	2.559	2.100	6.125	APH317-CS58	4.250	2.559	2.100	6.350	APP317-CS

Compstar LSx 8 Counterweight

Stroke:	Main:	Pin:	Cammed for Rod Length	Part #:	Stroke:	Main:	Pin:	Cammed for Rod Length	Part #:
3.625	2.559	2.100	6.098	APH31Q-CS	LT Wet Sump Post				
4.000	2.559	2.100	6.125	AWO31Q-CS	3.625	2.559	2.100	6.100	5TH-31Q-CS
4.000	2.559	2.100	6.125	APO31Q-CS	3.750	2.559	2.100	6.125	5TJ-31Q-CS
LS Wet Sump Post					4.000	2.559	2.100	6.125	5TO-31Q-CS
4.100	2.559	2.100	6.125	AP&-31Q-CS	LT Dry Sump Post				
4.125	2.559	2.100	6.125	APU-31Q-CS	3.625	2.559	2.100	6.100	5UH-31Q-CS
LS Dry Sump					3.750	2.559	2.100	6.125	5UJ-31Q-CS
3.625	2.559	2.100	6.100	AWH-31Q-CS	4.000	2.559	2.100	6.125	5UO-31Q-CS
4.000	2.559	2.100	6.125	AWO-31Q-CS					
4.125	2.559	2.100	6.125	AWU-31Q-CS					

Reluctors

Single piece billet reluctor wheels machined to OEM specification with either 24x or 58x notch patterns. Callies reluctor wheels for all LS and LT engines are final bored with a .007" undersize bore insuring installation security in the harshest of applications. All surfaces on Callies reluctor wheels are machine milled not laser cut to ensure smooth, strong signal.



McCain Racing "Bowser"

Callies LS Ultra Billet Crankshaft, Callies Finish Ground Camshaft, Energy LS Engine Block

LSx & GEN V LT1

* Pistons, Bearings and Finish Ground Cams also available.

Callies Connecting Rods

LS Ultra Enforcer I-Beam - Rated for 2,400 HP

Length:	Journal:	Typical Wt:	Part #:
6.125	2.100	662g.	U17175
6.125	2.100	710g.	U17175-3.5

LS Ultra I-Beam - Rated for 2,000 HP

Length:	Journal:	Typical Wt:	Part #:
6.125	2.100	662g.	U17171
6.125	2.000	.927 pin	U17172
6.350	2.100	674g.	U17178
6.350	2.100	655g. .866 pin	U17179
6.125	2.100	662g.	U17171-3.5
6.350	2.100	674g.	U17178-3.5

LS Ultra H-Beam - Rated for 1,600 HP

Length:	Journal:	Typical Wt:	Part #:
6.100	2.100	620g.	U16290
6.125	2.100	649g.	U16300
6.125	2.000		U16310
6.200	2.100	625g.	U16303
6.350	2.100	658g.	U16302
6.460	2.100	661g.	U16301

Compstar Connecting Rods

LS Compstar H-Beam- Rated for 1,000 HP

Length:	Journal:	Typical Wt:	Part #:
6.100	2.100	611g.	CSC6100DS2A2AH
6.100	2.100	612g. .943 pin	CSC6100DS6A2AH
6.125	2.000	595g.	CSC6125CS2A2AH
6.125	2.000	618g.	CSC6125DS2A2AH
6.340	2.000	630g.	CSC6340CS2A2AH
6.440	2.000	639g.	CSC6440CS2A2AH
6.560	2.100	655g.	CSC6560DS2A2AH



ENERGY MANUFACTURING

Energy Manufacturing offers LS Engine Blocks, Intake Manifolds and Cylinder Heads for LS engines. See pages 30 - 33 for full specs on these items.

Energy products can be purchased by contacting Energy directly or by talking to your Callies sales representative.



BIG BLOCK CHEVY

For over 30 years, Callies crankshafts have been the workhorse of Big Block Chevy engines in the motorsports industry. We are proud of this success and are pleased to offer continued excellence with our line of crankshafts, connecting rods, engine ready camshafts and Energy Manufacturing engine blocks, intake manifolds and cylinder heads.

BBC Ultra Billet

Standard Features:

- Bore spacings available: Standard 4.840", 4.900", 5.000", 5.300"
 - Stroke range of 3.400" to 6.125"
 - Flange options: 7/16" or 1/2" bolt holes available
 - Rod journal diameters available: 1.888", 2.000", 2.100", 2.200", 2.375"
- Hemi
- 8 or 6 counterweight designs available
 - Sold complete with no drill balance
 - Aero efficient Ultra-Shed counterweight profile
 - Aero-shed super finishing is standard
 - Various keyway configurations available
 - All Big Block Chevy Ultra Billet crankshafts are produced from high grade TimkenSteel material.
 - Splined Post (RCD Style) available



Aeroshed finish and Ultra-Shed counterweight profiling



Magnum Billet

Stroke:	Main:	Pin:	Cammed for Rod Length	Part #
4.625	2.750	2.200	6.700	BBR42K-MB
4.750	2.750	2.200	6.700	BBS42K-MB

Magnum Billet

Average weight range = 70 lbs.

Standard Features:

- Machined from 4340 billet
- Stroke range of 3.750" to 5.300"
- 2.200" rod journal diameters
- Standard BBC main bearing diameters
- All rod and main journals drilled for lightening
- Dual 1/4" post keyways
- Ultra-Case deep nitride heat treatment

Magnum

Stroke:	Main:	Pin:	Cammed for Rod Length	Part #
4.000	2.750	2.200	6.385	BBO42B-MG
4.250	2.750	2.200	6.385	BBP42B-MG
4.375	2.750	2.200	6.535	BBB42B-MG
4.500	2.750	2.200	6.700	BBQ42B-MG
4.750	2.750	2.200	6.700	BBS42B-MG
4.625	2.750	2.200	6.700	BBR42B-MG



Magnum Big Block Chevy

Average weight for 4.500" Stroke, Balanced to 2350g Bob. = 69 lbs.

Standard Features:

- Gun drilled mains, with 8 full counterweights
- All rod journals lightened
- Dual post keyways (additional available)
- Heat Treatment = Ultra Case Deep Nitride
- Enhanced rod oiling through the use of main bearing oil hole lead-ins
- One and two piece seal type flanges or star flange
- Custom flange bolt, dowel and post drilling available

Magnum Big Block Stock Eliminator

Stroke:	Main:	Pin:	Cammed for Rod Length	Part #
3.779	2.750	2.200	6.135	BB1542B-SE
4.013	2.750	2.200	6.135	BB1642B-SE

BIG BLOCK CHEVY



Magnum XL

	Stroke:	Main:	Pin:
Tier 1:	4.500 and under	2.750	2.200, 2.100
Tier 2:	4.501 and up	2.750	2.200, 2.100, 2.000, 1.888

Magnum XL

Average weight range: 58 lbs to 70 lbs.

Standard Features:

- Stroke Range of 3.500" to 4.750"
- 409 and conventional BBC main bearing diameters
- Various flange and post bolt hole configurations
- Dual post key-ways and deep hole post drilling
- Uniquely milled counterweight profiles for reduced weight and windage.
- Full internal balance to your specified assembly weight (no drilling)
- Gun drilled mains, with full 8 counterweights



Compstar:

Stroke:	Main:	Pin:	Cammed for Rod Length	Part #
4.250	2.750	2.200	6.385	IBP4525-CS
3.760	2.750	2.200	6.135	IB3425-CS
4.000	2.750	2.200	6.385	IBO425-CS
4.250	2.750	2.200	6.385	BBP425-CS
4.375	2.750	2.200	6.385	BBB425-CS
4.500	2.750	2.200	6.585	BBQ425-CS
4.750	2.750	2.200	6.700	BBS425-CS
3.760	2.750	2.200	6.385	BB3425-CS



1 pc. seal
1 pc. seal

Compstar Big Block Chevy

Average weight for 4.500" Stroke, Balanced to 2350g Bob. = 72 lbs.

Standard Features:

- 8 counterweight design
- All rod journals lightened
- Limited stroke availability
- Heat Treatment = Nitride Case



Compstar H5:

Stroke:	Main:	Pin:	Cammed for Rod Length	Part #
5.500	2.750	2.200	7.750	BQ+426-CS

Compstar H5 for 5.000" Spread Bore Engine Blocks

Average weight for 5.500" Stroke, Balanced to 2350g Bob. = 82 lbs.

Standard Features:

- 8 counterweight design
- All rod journals lightened
- Overlap Bars Integrated
- Limited stroke availability
- Heat Treatment = Nitride Case



Matt Bell

Callies Ultra Billet BBC Crankshaft, Energy BBC Engine Block, Heads and Manifold

* Pistons, Bearings and Cam Cores also available.

BIG BLOCK CHEVY

Callies connecting rods were designed for the harshest of applications. Choose from a variety of BBC rods from our top of the line Ultra Enforcer I-Beams to our value added Compstar H-Beams.

Big Block Enforcer I-Beam

Length	Journal	Typ. Wt.	Part #
6.385	2.200	867g.	U15210
6.535	2.200	877g.	U15211
6.385	2.200	867g.	U15210-3.5
6.535	2.200	877g.	U15211-3.5



Big Block Enforcer XD I-Beam

Length	Journal	Typ. Wt.	Part #
6.700	2.200	884g.	U18214
6.700	2.200	884g.	U18214-3.5

Big Block Ultra H-Beam

Length	Journal	Typ. Wt.	Part #
6.385	2.200	800g.	U16200
6.480	2.200	800g.	U16205
6.535	2.200	807g.	U16210
6.700	2.200	817g.	U16230

Big Block Ultra I-Beam

Length	Journal	Typ. Wt.	Part #
6.385	2.200	809g.	U15110
6.535	2.200	817g.	U15111
6.660	2.200	822g.	U15113
6.700	2.200	826g.	U15114
6.750	2.200	825g.	U15115
6.800	2.200	829g.	U15116
6.385	2.200	809g.	U15110-3.5
6.535	2.200	817g.	U15111-3.5
6.660	2.200	822g.	U15113-3.5
6.700	2.200	826g.	U15114-3.5
6.750	2.200	825g.	U15115-3.5
6.800	2.200	829g.	U15116-3.5

Big Block Ultra XD H-Beam

Length	Journal	Typ. Wt.	Part #
6.700	2.200	823g.	U19114

Compstar Big Block H-Beam

Length	Journal	Typ. Wt.	Part #
6.135	2.200	813g.	CSB6135ES3B9AH
6.385	2.100	732g.	CSB6385DS3B9AH
6.385	2.200	816g.	CSB6385ES3B9AH
6.535	2.200	820g.	CSB6535ES3B9AH
6.660	2.200	805g.	CSB6660ES3B9AH
6.700	2.200	825g.	CSB6700ES3B9AH
6.800	2.200	842g.	CSB6800ES3B9AH

Big Block Ultra Long I-Beam

Length	Journal	Typ. Wt.	Part #
7.100	2.200	848g.	U15270
7.200	2.200	853g.	U15280
7.100	2.200	848g.	U15270-3.5

Big Block Small Journal Ultra I-Beam

Length	Journal	Typ. Wt.	Part #
6.385	2.100	798g.	U15117
6.535	2.100	805g.	U15118
6.385	2.100	798g.	U15117-3.5
6.535	2.100	805g.	U15118-3.5



ENERGY
MANUFACTURING

BBC Engine Blocks, Intake Manifolds and Cylinder Heads are available from from Energy. See pages 30 - 33.

SMALL BLOCK CHEVY

No other brand of aftermarket components has seen the wide range of application and success as the Callies line for Small Block Chevy engines. With years of cross-application experience, no other brand has been able to provide the winning record and history of durability. You will find our line of crankshafts, connecting rods, and camshafts to be comprehensive and capable of handling your needs.



Ultra Billet Small Block Chevy

Available Options

- Types available: Standard 4.400, Spread Bore 4.500
- Stroke range of 2.600" to 4.500"
- BBC post or SBC post, various keyway configurations available
- Flange styles: Star or Full Round
- Rod journal sizes available: 1.850", 1.888", 2.000", 2.100"

* Also available in Ultra Boost and Ultra Dirt

- Main journal sizes available: 283, 350, 400
- 8 or 6 counterweight designs available
- Sold complete with no drill balance
- Aero efficient Ultra-Shed counterweight profiling is standard
- Aershod superfinishing included with all Ultra billets
- All Small Block Chevy Ultra billet crankshafts are produced from TimkenSteel 4330v material



Magnum Billet Small Block Chevy

Available Options

- Stroke range of 2.750" to 4.250"
- 2.100", 2.000", or 1.888" rod journal diameters
- Main journal sizes available: 283, 350, 400
- Average weight 47 lbs.
- 8 counterweight design
- Machined from TimkenSteel 4340

Magnum Billet Small Block Chevy

Stroke	Main	Pin:	Cammed for Rod Length	Part #
3.750	350	2.100	6.000	SMJ-11K-MB
3.850	350	2.000	6.000	SMM-14K-MB
4.000	350	1.888	6.000	SMO19K-MB
4.000	350	2.000	6.000	SMO14K-MB
4.000	400	2.000	6.000	SMO24K-MB
4.250	400	2.100	6.250	SMP21K-MB

Spread Bore 4.500" with Big Block Post

Stroke	Main	Pin:	Cammed for Rod Length	Part #
3.875	350	1.888	6.000	S4M-19K-MB
3.875	350	2.000	6.000	S4M-14K-MB
4.000	350	1.888	6.000	S4O-19K-MB
4.000	350	2.000	6.000	S4O-14K-MB

Magnum Billet XB

Average weight: for 3.875" stroke balanced to 1750g Bob. = 44 lbs or less

Available Options

- Stroke range of 2.750" to 4.250"
- 2.100", 2.000", 1.888" and 1.850" rod journal diameters
- Main journal sizes available: 283, 350, 400
- BBC post or SBC post available
- Full internal balance to your specific assembly weight (no drilling)
- 8 counterweight design
- Uniquely machined counterweight profile for reduced weight and windag

***Only a partial listing of available part numbers listed here.**



Magnum Billet XB

Stroke	Main	Pin:	Cammed for Rod Length	Part #
3.335	350	1.888	5.700	SAX-19K-XB
3.335	350	2.000	5.700	SAX-14K-XB
3.800	350	1.888	5.850	SAK-19K-XB
3.800	400	2.000	5.850	SAK-29K-XB
3.800	350	2.000	5.850	SAK-24K-XB
3.800	400	1.888	5.850	SAK-29K-XB

SMALL BLOCK CHEVY



Magnum XL Small Block Chevy

Average weight for 3.800" stroke balanced to 1750g Bob. = 44 lbs

Available Options

- Stroke range of 2.600" to 4.000"
- 2.100", 2.000", 1.888", 1.850" rod journal diameters
- 400 – 350 – 283 main bearing diameters
- BBC post or SBC post
- Uniquely milled counterweight profiles for reduced weight and windage
- All rod journals lightened
- Full internal balance to your specific assembly weight (no drilling)
- Various flange and post bolt hole configurations

Magnum XL

Stroke:	Main:	Pin:	Cammed for Rod Length	Part #
3.335	350	2.000	5.700	SKX14A-XL
3.335	350	Honda	5.700	SKX19A-XL
3.480	350	2.100	5.700	SKF11A-XL
3.480	350	Honda	5.700	SKF19A-XL
3.500	350	2.100	5.700	SKG11A-XL
3.500	350	2.000	5.700	SKG14A-XL
3.500	350	Honda	5.700	SKG19A-XL
3.550	350	Honda	5.700	SKT19A-XL
3.335	350	2.100	5.700	SKX11A-XL
3.480	350	2.000	5.700	SKF14A-XL
3.550	350	2.100	5.700	SKT11A-XL
3.550	350	2.000	5.700	SKT14A-XL
3.800	400	1.880	5.850	SKK29A-XL
3.800	400	2.000	5.850	SKK24A-XL
3.825	400	2.000	5.850	SK#24A-XL
3.800	400	2.100	5.850	SKK21A-XL
3.750	350	2.000	5.850	SKJ14A-XL
3.875	350	2.100	6.000	SKM11A-XL
3.875	350	2.000	6.000	SKM14A-XL
3.875	350	2.000	6.000	Big Block Post SOM14A-XL
4.000	350	2.100	6.000	SKO11A-XL
4.000	350	2.000	6.000	Big Block Post SOO14A-XL
4.000	350	2.000	6.000	SKO14A-XL
4.000	400	2.100	6.000	SKO21A-XL
4.000	400	2.000	6.000	SKO24A-XL

***Only a partial listing of available part numbers listed here.**



Sheldon Haudenschild

Callies Magnum XL Small Block Chevy Crankshaft



*** Pistons, Bearings and Cam Cores also available.**

SMALL BLOCK CHEVY



Magnum Small Block Chevy

Average weight: 48 lbs.

Standard Features

- Stroke range of 2.600" to 4.375"
- 2.100", 2.000", 1.888" rod journal diameters
- 400 – 350 – 283 main bearing diameters
- BBC post or SBC post
- One or two piece type rear seal flange
- Gun drilled mains
- All rod journals lightened

Magnum

Stroke:	Main:	Pin:	Cammed for Rod Length	Part #
3.335	350	1.888	5.700	SAX19A-MG
3.335	350	2.000	5.700	SAX14A-MG
3.335	350	2.100	5.700	SAX11A-MG
3.400	350	2.000	5.700	SAW14A-MG
3.480	350	1.888	5.700	SAF19A-MG
3.480	350	2.000	5.700	SAF14A-MG
3.480	350	2.100	5.700	SAF11A-MG
3.500	350	2.000	5.700	SAG14A-MG
3.500	350	1.888	5.700	SAG19A-MG
3.500	350	2.100	5.700	SAG11A-MG
3.550	350	2.000	5.700	SAT14A-MG
3.550	350	2.100	5.700	SAT11A-MG
3.625	350	1.888	5.750	SAH19A-MG
3.625	350	2.000	5.750	SAH14A-MG

Magnum

Stroke:	Main:	Pin:	Cammed for Rod Length	Part #
3.625	350	2.100	5.750	SAH11A-MG
3.750	350	2.100	5.850	SAXJ11A-MG
3.750	350	2.000	5.850	SAJ14A-MG
3.750	350	2.100	5.850	Big Block Post SMJ11A-MG
3.750	400	2.000	5.850	SAJ24A-MG
3.750	400	2.100	5.850	SAJ21A-MG
3.750	400	2.100	5.850	Big Block Post SMJ21A-MG
3.750	350	2.100	6.000	CAJ11A-MG
3.800	400	2.100	5.850	SAK21A-MG
3.875	350	5.211	5.850	CAM11A-MG
3.875	350	2.100	6.000	SAM11A-MG
3.875	400	2.100	6.000	SAM21A-MG
4.000	350	2.100	6.000	SAO11A-MG
4.000	400	2.100	6.000	SAO21A-MG



Compstar Small Block Chevy

Average weight for 3.750" Stroke, Balanced to 1750g. = 50 lbs.

Standard Features

- All Rod Journals Lightened
- Heat Treatment = Nitride Case

Compstar SBC

Stroke:	Main:	Pin:	Cammed for Rod Length	Part #	Stroke:	Main:	Pin:	Cammed for Rod Length	Part #
3.335	350	1.888	5.700	SAX19A-MG	3.500	350	2.000	5.700	SAG14A-MG
3.335	350	2.000	5.700	SAX14A-MG	3.500	350	1.888	5.700	SAG19A-MG
3.335	350	2.100	5.700	SAX11A-MG	3.500	350	2.100	5.700	SAG11A-MG
3.400	350	2.000	5.700	SAW14A-MG	3.550	350	2.000	5.700	SAT14A-MG
3.480	350	1.888	5.700	SAF19A-MG	3.550	350	2.100	5.700	SAT11A-MG
3.480	350	2.000	5.700	SAF14A-MG	3.625	350	1.888	5.750	SAH19A-MG
3.480	350	2.100	5.700	SAF11A-MG	3.625	350	2.000	5.750	SAH14A-MG

Compstar Racesaver

Standard Features

- Made for the 305 Racesaver Sprint Car class
- 4340 steel
- Rough balanced or counterweight prepped for 1525 bob weight
- Z100 Rod Journal



Stroke:	Main:	Pin:	Cammed for Rod Length	Part #
3.335	350	1.888	5.700	SAX19A-MG

SMALL BLOCK CHEVY

Compstar Comet SBC

Average weight for 3.750" Stroke, Balanced to 1750g. = 43 lbs

- Gun Drilled Mains
- All Rod Journals Lightened
- Heat Treatment = Nitride Case



Compstar Comet

Stroke:	Main:	Pin:	Cammed for Rod Length	Part #	Stroke:	Main:	Pin:	Cammed for Rod Length	Part #
3.335	350	2.000	5.700	SAX143-CC	3.500	350	2.000	5.700	SAG143-CC
3.480	350	1.888	5.700	SAF193-CC	3.750	350	2.000	6.000	SAJ143-CC
3.480	350	2.000	5.700	SAF143-CC	3.750	350	2.100	6.000	SAJ113-CC



Small Block Enforcer I-Beam

Length	Journal	Typ. Wt.	Part #
6.000	2.100		U18235 (XD)
6.200	2.100		U14245
6.200	2.100		U14245-3.5

Small Block Ultra XD I-Beam

Length	Journal	Typ. Wt.	Part #
5.850	2.100		U18130
6.000	2.100	651g.	U18135
6.000	2.100	660g.	U18135-3.5

Small Block Ultra I-Beam - Rated for 1,800 HP Drag Race and 950 HP Circle Track

Length	Journal	Typ. Wt.	Part #
5.700	2.100	642g.	U14125
5.850	2.000	629g.	U14131
5.850	2.100	650g.	U14130
6.000	2.000	635g.	U14136
6.000	2.100	655g.	U14135
6.125	2.000	643g.	U14141
6.125	2.100	660g.	U14140
6.200	2.100	666g.	U14145
6.200	2.000	643g.	U14146
6.250	2.000	649g.	U14151
6.250	2.100	668g.	U14150
5.850	Honda	584g.	U14132-3.5

Small Block Ultra I-Beam - continued

Length	Journal	Typ. Wt.	Part #
5.850	2.000	629g.	U14131-3.5
5.850	2.100	650g.	U14130-3.5
6.000	Honda	588g.	U14137-3.5
6.000	2.000	635g.	U14136-3.5
6.000	2.100	655g.	U14135-3.5
6.125	Honda	590g.	U14142-3.5
6.125	2.000	643g.	U14141-3.5
6.125	2.100	660g.	U14140-3.5
6.200	2.100	666g.	U14145-3.5
6.200	2.000	643g.	U14146-3.5
6.250	2.000	649g.	U14151-3.5
6.250	2.100	668g.	U14150-3.5

Small Block Light Weights - Rated for 850 HP

Length	Journal	Typ. Wt.	Part #
6.000	2.000	600g.	U14139
6.000	2.100	610g.	U14138
6.125	2.000	602g.	U14144
6.125	2.100	619g.	U14143
6.000	2.000	600g.	U14139-3.5
6.000	2.100	610g.	U14138-3.5
6.125	2.000	602g.	U14144-3.5

Small Block Ultra H-Beam - Rated for 1,400 HP HP Drag Race and 750 HP Circle Track

Length	Journal	Typ. Wt.	Part #
6.000	2.000	624g.	U16101
6.000	Honda	582g.	U16102
6.000	2.100	644g.	U16100
6.125	2.100	650g.	U16110
6.200	2.100	660g.	U16120
6.000	2.100	644g.	U19135 (XD)

SMALL BLOCK CHEVY



Compstar Small Block H-Beam - Rated for 700 HP



Length	Journal	Typ. Wt.	Part #
5.700	2.000	584g.	CSA5700CS2A2AH
5.700	2.100	606g.	CSA5700DS2A2AH
5.850	2.000	587g.	CSA5850CS2A2AH
5.850	2.100	612g.	CSA5850DS2A2AH
6.000	1.888	520g.	CSA6000AS2A0AH
6.000	2.000	593g.	CSA6000CS2A2AH
6.000	2.100	620g.	CSA6000DS2A2AH
6.125	2.000	596g.	CSA6125CS2A2AH
6.125	2.100	617g.	CSA6125DS2A2AH
6.200	2.000	598g.	CSA6200CS2A2AH
6.200	2.100	615g.	CSA6200DS2A2AH
6.250	2.100	619g.	CSA6250DS2A2AH
6.300	2.100	626g.	CSA6300DS2A2AH



*TRE Racing Engines
Justin Curry's '68 Camaro
Callies Magnum Billet SB Chevy Crankshaft*

FORD 460

Callies offers high quality domestically produced Ultra, Magnum XL and Magnum crankshafts and connecting rods for the entire line of Ford V8 engines that are targeted for high HP / high torque applications. Callies crankshafts for the Ford 460 are made with 3.018 inch long gear and damper fit post lengths. Our Ford 460 shafts are machined with dual damper keyways for blower applications.

Ultra Billet Ford 460

Available Options & Standard Features

- Stroke range of 3.625" to 5.300"
- Various post keyway configurations available
- Rod journal sizes: 2.100", 2.200"
- Main journal sizes: Ford 460
- 8 or 6 counterweight designs
- Shipped complete with no drill balance included
- Aero efficient Ultra-Shed counterweight profiling is standard
- Aeroshed super finishing included with all Ultra billets
- All Big Block Ford Ultra billet crankshafts are produced from TimkenSteel 4330v alloy steel
- Short damper fit (High Performance Style)



Magnum Billet Ford 460

Average weight: 79 lbs.

Standard Features

- Fully counterweighted (8 counterweight design)
- Machined with BBC post length & diameter
- Stroke range 3.625" to 5.000"
- Gun Drilled mains and lightened rods
- Perma Case deep nitride, 4340 steel
- Dual post keyways



Magnum Billet Ford 460

Stroke:	Main:	Pin:	Cammed for Rod Length	Part #	Stroke:	Main:	Pin:	Cammed for Rod Length	Part #
3.625	3.000	2.200	6.700	9GH-H2@-MB	4.500	3.000	2.200	6.700	9GQ-H2@-MB
4.150	3.000	2.200	6.700	9G2-H2@-MB	4.750	3.000	2.200	6.700	9GS-H2@-MB
4.300	3.000	2.200	6.700	9G4-H2@-MB					

Magnum Ford 460

Average weight: 78 lbs. for a 4.750" stroke

Standard Features

- Gun drilled mains
- Single 3/16 (Align- Ease) keyway with lead in witness mark with additional 1/4 key-way
- Short damper fit (High Performance Style)
- Heat Treatment = Perma Case Deep Nitride Options
- Full internal balance available



Magnum Ford 460

Stroke:	Main:	Pin:	Cammed for Rod Length	Part #	Stroke:	Main:	Pin:	Cammed for Rod Length	Part #
4.150	3.000	2.200	6.700	992-H29-MG	4.500	3.000	2.200	6.700	99Q-H29-MG
4.300	3.000	2.200	6.700	994-H29-MG	4.750	3.000	2.200	6.700	99S-H29-MG

Ford 460-429 Ultra I-Beam - Rated for 2,000 HP

Length	Journal	Typ. Wt.	Part #
6.700	2.200	826g.	U15814
6.800	2.200	828g.	U15816



* Pistons, Bearings and Cam Cores also available.

FORD 351 / 302

Ultra Billet Ford 351 / 302

Available Options

- Stroke range of 2.550" to 4.500"
- Various post keyway configurations available
- Rod journal sizes: 1.850", 1.888", 2.000", 2.100", 2.123"
- Main journal sizes: 302, 351
- 8 or 6 counterweight designs
- Shipped complete with no drill balance included
- Aero efficient Ultra-Shed counterweight profiling is standard
- Aero-shed super finishing included with all Ultra Billets
- Produced from TimkenSteel 4330v alloy steel

*** Also available in Ultra Boost**



Magnum XL Ford 351/302

Weight range of 39 lb. to 47 lb.

Available Options

- Stroke range of 2.600" to 4.500"
- Rod journal sizes 1.850", 1.888", 2.000", 2.100", 2.123"
- 351 Cleveland or 302 Ford type main diameters
- Full internal balance to your specific assembly weight (no drilling)
- Uniquely milled counterweight profiles for reduced weight and windage
- All rod journals lightened
- Gun drilled mains

***Only a partial listing of available part numbers listed here.**

Magnum XL Ford

Stroke:	Main:	Pin:	Cammed for Rod Length	Part #
3.400	302	2.100	5.400	UWJ01T-XL
3.250	302	2.100	5.400	UJE01T-XL
3.500	302	2.100	6.000	EDG01T-XL
3.500	351C	2.100	6.000	EFG71T-XL
3.625	351C	2.100	6.100	EFH71T-XL
3.750	351C	2.000	6.100	EFJ74T-XL
3.750	351C	2.100	6.100	EFJ71T-XL
4.000	351C	2.000	6.200	EFO74T-XL
4.000	351C	2.100	6.200	EFO71T-XL
4.125	351C	2.100	6.200	EFU71T-XL

***Only a partial listing of available part numbers listed here.**

Magnum XL Ford

Stroke:	Main:	Pin:	Cammed for Rod Length	Part #
3.500	351C	2.100	6.000	EDG01T-MG
3.500	351C	2.100	6.000	EFG71T-MG
3.500	302	2.100	6.000	UJG-01T-MG
3.625	351C	2.100	6.100	EFH71T-MG
3.750	351C	2.100	6.000	EFJ71T-MG
3.900	351C	2.100	6.200	EFC71T-MG
4.000	351C	2.100	6.200	EFO71T-MG
4.125	351C	2.100	6.200	EFU71T-MG
4.250	351C	2.100	6.200	EFP71T-MG
3.250	302	2.123	5.400	UJE0BT-MG
3.400	302	2.123	5.400	UJW0BT-MG
3.750	351C	2.000	6.100	EFJ74T-MG
4.000	351C	2.000	6.200	EFO74T-MG



Magnum Ford 351/302

**Average weight for 3.800" stroke balanced to 1750g
Bob. = 48 lbs**

Standard Features

- Gun drilled mains
- All rod journals lightened
- Stroke availability from 2.600" to 4.375"
- Heat Treatment = Perma Case Deep Nitride

Special Options

- Additional post keyways, custom post drilling
- 2.100", 2.000", 1.888", and 1.825" rod journal diameters
- 351 Cleveland or 302 Ford type main diameters

FORD 351 / 302

Compstar Ford 302 and 351

Average weight 47 lbs.

Standard Feature

- Machined from 4340 steel
- All rod journals lightened
- Heat treatment = nitride case
- Limited rod journal diameters = 2.123
- Limited main journal diameter = 302
- Limited stroke availability 3.250, 3.400



Compstar Ford 302

Stroke:	Main:	Pin:	Cammed for Rod Length	Part #
3.250	302	2.123	5.400	UJE0BM-CS
3.400	302	2.123	5.400	UJW0BM-CS

Compstar Ford 351

Stroke:	Main:	Pin:	Cammed for Rod Length	Part #
3.500	351-2.750	2.100	6.000	EFU-71U-CS

Ford SVO Enforcer I-Beam

Length	Journal	Typ. Wt.	Part #
6.125	2.100	705g.	U17175
6.125	2.100	710g.	U17175-3.5



Ford 351 Ultra I-Beam - Rated for 1,800 HP

Length	Journal	Typ. Wt.	Part #
6.200	2.000	.866 pin	U14846
6.200	2.100	670g.	U14845
6.250	2.100	671g.	U14850
6.250	2.000	635g. .866 pin	U14851
6.200	2.000		U14846-3.5
6.200	2.100	670g.	U14845-3.5
6.250	2.100	671g.	U14850-3.5

Ford 302 H-Beam - Rated for 1,500 HP

Length	Journal	Typ. Wt.	Part #
5.400	2.123	575g.	U16600
6.000	2.100	651g.	U18135
6.000	2.100	660g. .927 pin	U18135-3.5

Compstar Small Block Ford H-Beam

Length	Journal	Typ. Wt.	Part #
5.400	2.123	571g.	CSF5400HSF2AH

* Pistons, Bearings and Cam Cores also available.

ENERGY

MANUFACTURING



SBF Engine Blocks, Intake Manifolds and Cylinder Heads are available from from Energy. See pages 30 - 33.

419.435.2711 • www.callies.com 27

FORD COYOTE & FORD MODULAR

Ford Coyote and Ford Modular engines have proven their exceptional capabilities both at the track and on the street. Callies Compstar 4340 Steel Crankshafts were designed to support the additional horsepower and torque being generated in these applications. These cranks are machined with large strength enhancing journal radii like all Compstar crankshafts and come nitrited. All standard OEM driveline, valvetrain and accessory components can still be utilized.

Ford Coyote and Ford Modular

Average weight: 46 lbs.

Standard features

- Machined from 4340 Steel
- All rod journals lightened
- Heat treatment = Nitride Case



Ford Coyote

Stroke:	Main:	Pin:	Cammed for Rod Length	Part #
3.650	2.656	2.087	5.850	2242BTL-CS
3.800	2.656	2.100	5.850	22K-B1L-CS
3.900	2.656	2.000	5.850	22C-B4L-CS

Ford Modular

Stroke:	Main:	Pin:	Cammed for Rod Length	Part #
3.543	2.657	2.086	5.933	S24014-CS
3.750	2.657	2.000	5.850	S24015-CS
3.800	2.657	2.000	5.850	S24016-CS



Ford Coyote Ultra H-Beam

Length	Journal	Typ. Wt.	Part #
5.850	2.000	.866 pin	U16611
5.850	1.888	.866 pin	U16612
5.850	2.100	.866 pin	U16610

Ford Modular Ultra I-Beam - Rated for 2,000 HP

Length	Journal	Typ. Wt.	Part #
5.933	2.239	639g. .866 pin	U14825
5.933	2.239	639g.	U14825-3.5

Compstar Ford Modular H-Beam

Length	Journal	Typ. Wt.	Part #
5.933	2.239	635g. .866 pin	C24105
6.657	2.239	680g. .866 pin	C24106



Chris Holbrook

Ford Coyote Crankshaft and Ultra H Coyote Rods

* Pistons and Bearings also available.

RY45 & VIPER V-10

All Ultra RY45 crankshafts are precisely machined for the revolutionary RY45 engine. No detail has been spared in producing the ultimate in strength and durability. RY45 crankshafts feature eight counterweights that are profiled with the unique windage reducing Ultra-Shed profiling. These billet crankshafts are machined from TimkenSteel 4330v steel that has been carefully Ion Nitrided for superior wear and fatigue characteristics.

Ultra Billet RY45

Available Options & Standard Features

- Stroke range = 3.500" to 4.000"
- RY45 Post and Flange
- Available Rod Journal Diameters 1.850", 1.888", 2.000", 2.100"
- Full internal balance and Aeroshed surface treatment included



Contact the Callies sales team for a full list of part numbers and options.

For all-out performance Viper engine builds, your answer for durability is the Compstar billet crankshaft. Produced from 4340 steel that is heat treated multiple times before final nitride, these shafts are tough and wear resistant. Compstar Vipers can be ordered with either 58 or 10 tooth timing configurations. For improved rod journal oiling, these shafts feature straight shot oil holes running directly from mains to rods. Post bolt holes are deep drilled for 3/4 x 16 threads, significantly strengthening the accessory drive damper fit for super charger applications.

Compstar Viper V-10

Standard Features

- 2.100" or 2.123" rod journal diameters
- Standard Viper V-10 main bearings
- 7/16 x 20 flange bolt holes
- Deep hole post drilling, 3/4 x 16 threads



Compstar Viper V-10

Stroke:	Main:	Pin:	Cammed for Rod Length	Part #
3.960	3.000	2.125	6.200	KV329JH-CS
4.200	3.000	2.100	6.200	KV1291H-CS



Tony Calvo

Viper V-10 crankshaft & Ultra Enforcer connecting rods



RY45 Ultra I-Beam - Rated for 2,000 HP

Length	Journal	Typ. Wt.	Part #
6.125	2.000	618g.	U14844-3.5

Compstar Viper V-10 H-Beam - Rated for 1,000 HP

Length	Journal	Typ. Wt.	Part #
6.150	2.125		CSD6150GS2E1AH
6.250	2.125	628g.	CSD6250GS2E1AH

MOPAR / GEN III HEMI

Performance specific and durability enhanced, Callies crankshafts for the Big Block Mopar and Gen III Hemi are ready for anything your racing program can throw at them. With years of Mopar experience Callies has created an unsurpassed crankshaft for your Wedge or Hemi type engine.

Ultra Series for Big Block Mopar Top Fuel, Top Alcohol, Blower Drive

Standard Features

- Machined from EN30B alloy steel
- Rod journal diameters: 2.375" with large .180" fillet radii
- Main journal diameters: 2.750" or 3.000" with large .150" fillet radii
- RCD Splined post: long 2.340" or short 1.420" spline engagement available
- Sold complete with no drill balance included
- Aeroshed super finishing is standard
- Fully counterweighted with large, bearing saver counterweights
- All rod and main journals drilled for lightening
- PSI / RCD Spline Post Hemi Forged Billet also available

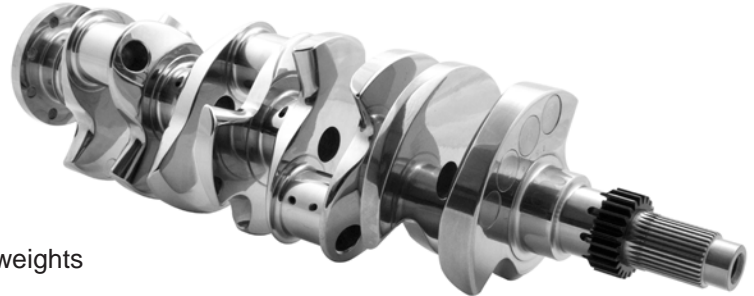

Mopar Magnum Billet

Average weight for a 4.500" stroke balanced to 2350g Bob. = 69 lbs.

Available Options & Standard Features

- Center counterweights
- 4340 AQ Steel
- Gun drilled mains
- All Rod Journals Lightened
- Dual Post Keyways
- Stroke availability 4.125" to 4.750"
- 2.200 BB Chevy rod journal dia. & width



Mopar Magnum Billet

Stroke:	Main:	Pin:	Cammed for Rod Length	Part #	Stroke:	Main:	Pin:	Cammed for Rod Length	Part #
4.150	2.750	2.200	6.700	GE262K-MB	4.625	2.750	2.200	7.100	GER62K-MB
4.250	2.750	2.200	6.700	GEP62K-MB	4.750	2.750	2.200	7.100	GES62K-MB
4.500	2.750	2.200	7.100	GEQ62K-MB					

Mopar Magnum

Average weight for a 4.500" stroke balanced to 2350g Bob. = 64 lbs.

Available Options & Standard Features

- Gun drilled mains
- All Rod Journals Lightened
- Dual Post Keyways
- Stroke availability 3.750" to 5.00"
- Heat Treatment = Ultra Case Deep Nitride
- Custom Flange Bolt & Dowel Drilling
- 2.200 BB Chevy dia. & width, 2.375 Mopar rod journal dia. & width



Mopar Magnum

Stroke:	Main:	Pin:	Cammed for Rod Length	Part #	Stroke:	Main:	Pin:	Cammed for Rod Length	Part #
4.150	2.750	2.200	6.700	GE262J-MP	4.625	2.750	2.200	7.100	GER62J-MP
4.250	2.750	2.200	6.700	GEP62J-MP	4.750	2.750	2.200	7.100	GES62J-MP
4.500	2.750	2.200	7.100	GEQ62J-MP					

MOPAR / GEN III HEMI

Gen III Ultra Billet Hemi

Average weight = 60 lbs.

Standard Features

- Fully (8) Counterweighted design
- Machined from TimkenSteel 4340
- Uniquely machined counterweight profile for reduced weight and windage
- Gun drilled mains
- Full internal balance to your specific assembly weight No Drilling
- All rod journals lightened
- Heat Treatment = Ultra Case Deep Nitride
- Full support pin top for added strength



Compstar Hemi Crankshafts are manufactured from 4340 steel and machined to popular strokes. These shafts will easily increase the power potential of Chrysler 6.4, 6.1, and 5.7 liter engines. Compstar Hemis can be ordered with either 32 or 60-2 reluctor wheels.



Compstar Gen III Modern Hemi

Average weight for 4.050" stroke balanced to 1785g
Bob. = 57 lbs.

Standard Features

- Sold prepred for a 1785g. Bob weight
- Gun drilled mains
- All rod journals lightened
- Dual linear post keyways
- limited stroke availability

Compstar Gen III Modern Hemi

Stroke:	Main:	Pin:	Cammed for Rod Length	Part #
3.800	2.559	2.100	6.125	YYKE18-CS
4.000	2.559	2.100	6.125	YYOE18-CS
4.050	2.559	2.100	6.125	YY*E18-CS
4.080	2.559	2.100	6.125	YYAE18-CS
4.200	2.559	2.100	6.125	YY12E48-CS

Compstar 8 Counterweight Hemi

Stroke:	Main:	Pin:	Cammed for Rod Length	Part #
3.800	2.559	2.100	6.125	YK-E1Q-CS
4.000	2.559	2.100	6.125	YYA-E1Q-CS
4.050	2.559	2.100	6.125	YY*-E1Q-CS
4.080	2.559	2.100	6.125	YYO-E1Q-CS



Compstar Hemi H-Beam - Rated for 1,000 HP

Length	Journal	Typ. Wt.	Part #
6.125	2.100	617g.	CSA6125DS2A2AH

A licensing deal with Fiat Chrysler Automobiles now allows Energy Manufacturing and Callies Performance to manufacture and distribute the 426 Hemi and the 440 Wedge cast iron engine blocks and cylinder heads. More details can be found on pages 30-33.



OFFICIAL
LICENSED
PRODUCT

Ultra Billet Duramax

Standard Features

- Stock and custom strokes available
- Reduced width 2.165" rod journals for additional strength
- All rod journals drilled with lightening holes
- Dual damper keyways
- Single long timing gear keyway for secure installation
- Mains gun drilled
- Custom rod journals upon request
- Timing gear available



DuraMag

Stroke:	Main:	Pin:	Cammed for Rod Length	Part #
3.898	3.146	2.477	6.418	D333MU@-MB

DuraMag

Standard Features

- Deep DuraCase nitride treatment that is durability and wear enhancing
- Large True Form fillet
- Keyed sheared proof timing gear fit
- Dual Keyed shear proof shout
- Drilled rod journals for reduced inertia and ease of balance
- Standard Duramax diameter but with strength enhancing 2.154 width
- Machined from 4340 hardened steel
- Main bearing oil holes are machined with lead-ins for enhanced cold start oil flow to rod journals
- Will accept OEM post and flange bolts

DuraStar

Standard Features

- Deep DuraCase nitride treatment that is durability and wear enhancing
- Large True Form fillet radii in all journals
- Keyed sheared proof timing gear fit
- Drilled rod journals for reduced inertia and ease of balance
- Stock 3.898" stroke with OEM journal diameters and width
- Machined from 4340 through hardened steel
- Dual keyed damper fit
- Conservatively rated for 800hp @ 800 ft/lb torque
- Main bearing oil holes are machined with lead-ins for enhanced cold start oil flow to rod journals
- Will accept OEM post and flange bolt



DuraStar

Stroke:	Main:	Pin:	Cammed for Rod Length	Part #
3.898	3.146	2.477		D333M81-CS



Ultra Assassin: Power Stroke 6.0L 2003-2009

Length	Journal	Typ. Wt.	Part #
6.929	2.874	1,233g.	U13100

6.4 Power Stroke Coming Soon

* Pistons, Bearings, Finish Ground Cams and Cam Cores also available.



Brodozer
Duramax Ultra Billet Crankshaft

NISSAN GT-R

At Callies, design consideration has been given to address the inadequacies of OEM crankshafts for the GT-R engine. Each Callies GT-R crank is carefully monitored, beginning with ultra pure 4330v steel that receives multiple heat treatments through final nitride & polish. Two post lengths - extended and standard - are available for dry and wet sump applications. Callies GT-R crankshafts are machined to accommodate 2.200" Big Block Chevy or Nissan rod journal diameters. These common diameters will allow engine builders easy access to a wide variety of bearing options. Standard main bearing, post and seal diameters are used throughout this crankshaft.



Nissan GT-R Ultra Billet

Stroke:	Main:	Pin:	Part #
88.4mm	2.558	2.200	VIF-NI@-UL
94.4mm	2.558	2.200	VI43NI@-UL
98.4mm	2.558	2.200	VI50NI@-UL

Nissan GT-R Ultra Billet

Average weight 45 lbs

Standard Features

- Aeroshed super finish
- No-drill balance
- Aero-efficient Ultra-Shed profiling
- Straight shot oiling
- Deep-Case Nitriding performed and certified in house
- OEM main, post and seal diameters

Nissan VR38/GT-R Ultra Enforcer I-Beam

Rated for 2,000 HP

Length	Journal	Typ. Wt.	Part #
6.500	2.205	714g.	U15400
6.500	2.200	709g.	U15405

Nissan VR38/GT-R Ultra Sport Series I-Beam

Rated for 1,600 HP

6.500	2.205	714g.	U15300
-------	-------	-------	--------

Nissan VR38/GT-R Ultra Sport Series H-Beam

Tapered Pin End - Rated for 1,100 HP

Length	Journal	Typ. Wt.	Part #
6.500	2.205		U16510



Tony Palo
GTR Ultra Billet Crankshaft and Callies Ultra Rods

SPORT SERIES - HONDA

Designed for Maximum Effort engines, all SS (Sport Series) crankshafts are finished with the same care and detail as the entire line of Compstar crankshafts. All SS cranks are sold balanced and ready for assembly. SS crankshafts by Compstar feature the best metallurgy and heat treatment on the market today. Sport Series (SS) connecting rods are available with either ARP 2000 or Custom Age 625 bolts for High Output applications. All Sport Series rods are H-beam design machined from fine grained 4340 steel.



Honda B Series

Average weight 30 lbs.

Standard Features

- B18 Strokes available 87.2, 89, 92, 95 mm
- 8 counterweight design
- 4340 steel certified by Callies in house Metallurgical lab
- Ultra-Case nitriding performed and certified by Callies
- Rod and main journal surface finish refined to 4Ra or less
- All journals ground with strength enhancing Tru-Form radii
- Limited stroke availability
- Aeroshed finishing optional

Honda B18 Billet

Stroke:	Main:	Pin:	Part #
95mm	55mm	45mm	S22002



Honda B18 Full Counterweight

Stroke:	Main:	Pin:	Part #
87.2mm	55mm	45mm	S22008
89mm	55mm	45mm	S22009
92mm	55mm	45mm	S22001



Honda K Series

Stroke:	Main:	Pin:	Part #
90.7mm	55mm	45mm	S22003
99.9mm	55mm	45mm	S22004
106mm	55mm	45mm	S22005
102mm	55mm	45mm	S22006

Honda K Series

Average weight 33 lbs.

Standard Features

- Strokes 90.7, 99.9, 102 & 106 mm
- Fully Counterweighted Design
- 4340 steel certified by Callies in house Metallurgical lab
- Ultra- Cryo treatment performed in house at Callies
- Ultra-Case nitriding performed and certified by Callies
- Rod and main journal surface finish refined to 4Ra or less
- All journals ground with strength enhancing Tru-Form radii
- No Drill internal balance
- Aeroshed finishing optional

Honda F Series

Average weight 37 lbs.

Standard Features

- Strokes available 84 mm
- 8 counterweight design
- 4340 steel certified by Callies in house Metallurgical lab
- Ultra-Case nitriding performed and certified by Callies
- Rod and main journal surface finish refined to 4Ra or less
- All journals ground with strength enhancing Tru-Form radii
- Limited stroke availability
- Aeroshed finishing optional



Honda F Series

Stroke:	Main:	Pin:	Part #
84mm	55mm	45mm	S22007
90.7mm	55mm	45mm	S22010

SPORT SERIES - HONDA

Honda K24 SS Connecting Rod H-Beam

Length	Journal	Pin	Part #
5.985" / 152mm	2.008" / 51mm	0.866" / 22mm	C22104
5.985" / 152mm	2.008" / 51mm	0.866" / 22mm	C22104-CA

Honda K20 SS Connecting Rod H-Beam

Length	Journal	Pin	Part #
5.472" / 138mm	2.008" / 51mm	0.866" / 22mm	C22105
5.472" / 138mm	2.008" / 51mm	0.866" / 22mm	C22105-CA

Honda B16 SS Connecting Rod H-Beam

Length	Journal	Pin	Part #
5.291" / 134mm	1.890" / 45mm	0.827" / 21mm	C22101
5.291" / 134mm	1.890" / 45mm	0.827" / 21mm	C22101-CA

Honda B18C SS Connecting Rod H-Beam

Length	Journal	Pin	Part #
5.433" / 138mm	1.890" / 45mm	0.827" / 21mm	C22102
5.433" / 138mm	1.890" / 45mm	0.827" / 21mm	C22102-CA

Honda B18 A/B & B20 SS Connecting Rod H-Beam

Length	Journal	Pin	Part #
5.394" / 137mm	1.890" / 45mm	0.827" / 21mm	C22103
5.394" / 137mm	1.890" / 45mm	0.827" / 21mm	C22103-CA



4 Piston Racing - OGS All Motor World Record
Compstar 99.9 mm K Series Crankshaft

SPORT SERIES - NISSAN

Callies Sport Series Nissan engines provide a comprehensive offering of components for every application, regardless how rigorous. Our range of material and design will allow you to find Sport Series crankshafts and connecting rods that re ideal for your build. You will find the variety of our components to provide the perfect solution to your needs regardless if you have 2,500 HP or 500 HP.



Nissan SR20

Stroke:	Main:	Pin:	Part #
91mm	54.9mm	45mm	S22007

Nissan SR20

Average weight: 37 lbs

Standard Features

- 91MM Stroke
- Factory Main and Rod Journal sizes
- Fully Counterweighted
- Straight Shot Oiling
- Material Certified by Callies in house Metallurgical Lab
- Ultra Cryo Treatment performed in house at Callies
- Ultra-Case Nitriding performed and certified in house
- All Journal ground with strength enhancing Tru-Form radii
- Rod and Main Journals finished to a 4RA or less
- No Drill Finish Balance
- Aeroshed finishing optional

Nissan RB26

Average weight: 42 lbs

Standard Features

- Available in Standard and Full Counterweight
- 4340 Steel Certified by Callies in house Metallurgical Lab
- Ultra-Cryo treatment performed and certified by Callies
- Ultra-Case nitriding performed and certified by Callies
- All journals ground with strength enhancing Tru-Form radii
- Rod and main journal surface finish is refined to 4Ra or less
- Tear drop oil hole lead-ins
- Straight Shot Oiling
- No drill internal balance
- Aeroshed finishing optional



Nissan SR26

Stroke:	Main:	Pin:	Part #
73.7mm	54.9mm	47.9mm	S25005
77.7mm	54.9mm	47.9mm	S25004
79mm	54.9mm	47.9mm	S25001

Nissan SR26 - Full CWT

Stroke:	Main:	Pin:	Part #
73.7mm	54.9mm	47.9mm	S25006
77.7mm	54.9mm	47.9mm	S25007
79mm	54.9mm	47.9mm	S25008



Nissan RB30

Stroke:	Main:	Pin:	Part #
90mm	54.9mm	49.9mm	S25011
90mm	54.9mm	49.9mm	S25009 Full CWT Long Post

Nissan RB30

Average weight: 69 lbs

Standard Features

- Standard and long post available
- 4340 Steel Certified by Callies in house Metallurgical Lab
- Ultra-Cryo treatment performed and certified by Callies
- Ultra-Case nitriding performed and certified by Callies
- All journals ground with strength enhancing Tru-Form radii
- Rod and main journal surface finish is refined to 4Ra or less
- Tear drop oil hole lead-ins
- Straight Shot Oiling
- No drill internal balance
- Aeroshed finishing optional

SPORT SERIES - NISSAN

Nissan VG30

Average Weight: 41 lbs

Standard Features

- Factory Main and Rod Journal Sizes
- Straight Shot Oiling
- Material Certified by Callies in house Metallurgical Lab
- Ultra Cryo Treatment performed in house at Callies
- Ultra-Case Nitriding performed and certified in house
- All Journal ground with strength enhancing Tru-Form radii
- Rod and Main Journals finished to a 4RA or less
- No Drill Finish Balance
- Aeroshed finishing optional



Nissan SR26

Stroke:	Main:	Pin:	Part #
83mm	62.9mm	49.9mm	S25002

Nissan VR38/GT-R Ultra Enforcer I-Beam

Rated for 2,000 HP

Length	Journal	Typ. Wt.	Part #
6.500	2.205	714g.	U15400
6.500	2.200	709g.	U15405

Nissan VQ35 SS Connecting Rod H-Beam

Length	Journal	Pin	Part #
5.677" / 144mm	2.165" / 55mm	0.866" / 23mm	C25101
5.677" / 144mm	2.165" / 55mm	0.866" / 23mm	C22101-CA

Nissan VR38/GT-R Ultra Sport Series I-Beam

Rated for 1,600 HP

Length	Journal	Typ. Wt.	Part #
6.500	2.205	714g.	U15300

Nissan VR38/GT-R Ultra Sport Series H-Beam

Tapered Pin End - Rated for 1,100 HP

Length	Journal	Typ. Wt.	Part #
6.500	2.205		U16510



Jorge Lazcano
Nissan RBx Drag Extreme

SPORT SERIES - MITSUBISHI



Mitsubishi 4G63 6 Bolt

Average weight 36 lbs

Stroke:	Main:	Pin:	Part #
88mm	57mm	45mm	S23013
100mm	57mm	45mm	S23015

Mitsubishi 4G63 7 Bolt

Average weight 33 lbs

Stroke:	Main:	Pin:	Part #	
88mm	57mm	45mm	S23002	Forged
100mm	57mm	45mm	S23008	Forged
88mm	57mm	45mm	S23001	Billet
94mm	57mm	45mm	S23003	Billet
100mm	57mm	45mm	S23007	Billet
102mm	57mm	45mm	S23009	Billet

Mitsubishi 4G63 Billet and Forged

Standard Features

- 8 counterweight design
- 4340 steel certified by Callies in house Metallurgical lab
- Ultra-Case nitriding performed and certified by Callies
- Rod and main journal surface finish refined to 4Ra or less
- All journals ground with strength enhancing Tru-Form radii
- Limited stroke availability
- Aeroshed finishing optional

Mitsubishi 4G63 7 Bolt - Full CWT

Average weight 36 lbs

Stroke:	Main:	Pin:	Part #	
88mm	57mm	45mm	S23017	Full CWT
94mm	57mm	45mm	S23018	Full CWT
100mm	57mm	45mm	S23019	Full CWT
102mm	57mm	45mm	S23020	Full CWT



4G63 Ultra Enforcer Connecting Rod I-Beam

Length	Journal	Pin	Part #
6.024" / 153mm	1.890" / 45mm	0.866" / 22mm	U16740
6.142" / 156mm	1.890" / 45mm	0.866" / 22mm	U16750
5.906" / 150mm	1.890" / 45mm	0.866" / 22mm	U16730

4B11T Ultra Enforcer Connecting Rod I-Beam

Length	Journal	Pin	Part #
5.659" / 144mm	2.165" / 52mm	0.906" / 23mm	U16720-3.5

Mitsubishi 4G63 SS Connecting Rod H-Beam

Length	Journal	Pin	Part #
5.906" / 150mm	1.890" / 45mm	0.866" / 22mm	C23101
5.906" / 150mm	1.890" / 45mm	0.866" / 22mm	C23101-CA
6.142" / 156mm	1.890" / 45mm	0.866" / 22mm	C23103
6.378" / 162mm	1.890" / 45mm	0.866" / 22mm	C23104

Mitsubishi 4B11T SS Connecting Rod H-Beam

Length	Journal	Pin	Part #
5.659" / 144mm	2.165" / 52mm	0.906" / 23mm	C23102
5.659" / 144mm	2.165" / 52mm	0.906" / 23mm	C23102-CA



Mitsubishi 4B11

Average weight 32 lbs

Standard Features

- 8 counterweight design
- 4340 steel certified by Callies in house Metallurgical lab
- Ultra-Case nitriding performed and certified by Callies
- Rod and main journal surface finish refined to 4Ra or less
- All journals ground with strength enhancing Tru-Form radii
- Limited stroke availability
- Aeroshed finishing optional

Mitsubishi 4B11 Billet

Average weight 36 lbs

Stroke:	Main:	Pin:	Part #
94mm	52mm	52mm	S23004
96mm	52mm	52mm	S23005
98mm	52mm	52mm	S23006

SPORT SERIES - SUBARU

Subaru EJ20 / EJ25

Average weight 18 lbs.

Standard Features

- All rod journals drilled for lightening
- Material certified by Callies in house Metallurgical lab
- Ultra-Case nitriding performed and certified in house
- All journal diameters are held to .0005" tolerance
- Rod and main journal surface finish is refined to 4Ra or less
- Limited stroke availability
- Aeroshed finishing optional



Subaru EJ20 / EJ25

Stroke:	Main:	Pin:	Part #
75mm	60mm	52mm	S26001
79mm	60mm	52mm	S26002
83mm	60mm	52mm	S26005



Subaru FA20

Average weight 18 lbs.

Standard Features

- All rod journals drilled for lightening
- Material certified by Callies in house Metallurgical lab
- Ultra-Case nitriding performed and certified in house
- All journal diameters are held to .0005" tolerance
- Rod and main journal surface finish is refined to 4Ra or less
- Limited stroke availability
- Aeroshed finishing optional

Subaru EJ20 / EJ25

Stroke:	Main:	Pin:	Part #
86mm	68mm	50mm	S26008

EJ20 Ultra Enforcer Connecting Rod I-Beam

Length	Journal	Pin	Part #
5.138" / 130mm	2.047" / 52mm	0.905" / 23mm	U16700-3.5
5.217" / 133mm	2.047" / 52mm	0.905" / 23mm	U16710-3.5 (+2mm)
5.295" / 134.5mm	2.1656" / 55mm	0.9063" / 23mm	U16715-3.5 (+4mm)

EJ20 SS Connecting Rod H-Beam

Length	Journal	Pin	Part #
5.138" / 130mm	2.047" / 52mm	0.905" / 23mm	C26101
5.138" / 130mm	2.047" / 52mm	0.905" / 23mm	C26101-CA

EJ20 + 2mm SS Connecting Rod H-Beam

Length	Journal	Pin	Part #
5.217" / 133mm	2.047" / 52mm	0.905" / 23mm	C26102
5.217" / 133mm	2.047" / 52mm	0.905" / 23mm	C26102-CA

FA20 SS Connecting Rod H-Beam

Length	Journal	Pin	Part #
5.091" / 129mm	2.084" / 53mm	0.867" / 22mm	C26103
5.091" / 129mm	2.084" / 53mm	0.867" / 22mm	C26103-CA



SPORT SERIES - TOYOTA

Machined as an enhancement to the formidable Toyota 2JZ engine, Compstar Sport Series crankshafts are your best choice for extreme durability. Beginning with high grade 4340 steel and finished with the proven Callies premium in house nitride treatment these crankshafts are start to finish the best available in today's market. Available in three strokes, all 2JZ shafts are machined to accommodate standard rod and main journal sizes.



Toyota 2JZ

Average weight 47.5 lbs

Standard Features

- Material certified by Callies in house Metallurgical Lab
- Ultra Cryo Treatment performed in house at Callies
- Ultra-Case nitriding performed and certified in house
- All journal diameters are held to .0005 tolerance
- Tear Drop Lead ins on Main oiling holes
- Scalloped Counterweights for weight reduction
- No Drill Finish Balance optional
- Aeroshed finishing optional
- 2JZ Oil Pump Post Spline Gear also available

Toyota 2JZ - Full CWT

Stroke:	Main:	Pin:	Part #
86mm	62mm	52mm	S27004
91mm	62mm	52mm	S27005
94mm	62mm	52mm	S27006

*** Toyota 2JZ Oil Pump Post Spline Gear also available**

Toyota 2JZ - Honda Pin

Stroke:	Main:	Pin:	Part #
86mm	62mm	47.95mm	S27007
90mm	62mm	47.95mm	S27008
91mm	62mm	47.95mm	S27009
94mm	62mm	47.95mm	S27010
96mm	64mm	47.95mm	S27011

Toyota 2JZ Ultra Enforcer I-Beam

Length	Journal	Pin	Part #	Fastener
5.590" / 142mm	2.047" / 52mm	0.866" / 22mm	U18100-3.5	3/8" ARP 3.5 Multiphase
5.590" / 142mm	1.888" / 48mm	0.866" / 22mm	U18101	7/16" ARP H11



Shiraz Kamal

Toyota 2JZ Crankshaft and Ultra Enforcer Connecting Rods

SPORT SERIES - FORD ECOBOOST

Callies Sport Series components for the Ford Duratec / EcoBoost engine system have been designed with seamless integration in mind. Callies has meticulously examined prints and products to insure Sport Series components are compatible and easily installed into your next project. Every component has been designed or modified to offer specific performance advantages. Callies offers 1.6 L, 2.3 L lightweight and heavy weight and 3.5L EcoBoost crankshafts.

Ford 1.6 L EcoBoost

Average Weight 27 lbs

Standard Features

- Stroke available 81.4 mm
- Fully Counterweighted Design
- 4340 Steel Certified by Callies in house Metallurgical Lab
- Ultra-Cryo treatment performed in house at Callies
- Ultra-Case Nitriding performed and Certified by Callies
- All journals ground with strength enhancing Tru-Form radii
- Rod & main journals finished to 4Ra or less
- Gun Drilled Mains
- Lightened Rod Journals
- Tear drop lead in main oil holes
- No Drill Internal Balance Included
- Aeroshed finishing optional



Ford 1.6 L EcoBoost

Stroke:	Main:	Pin:	Part #
81.40mm	48mm	44mm	S24001
91.40mm	48mm	44mm	S24008



Ford 2.3 L EcoBoost - Lightweight Factory Modified with a weight reduction of over 9 lbs

Standard Features

- Guaranteed weight under 34 lbs
- All 4 rod journals are drilled for reduced inertia
- Internal balance shaft drive gear removed
- Ultra-Cryo Treatment performed in house at Callies
- Keyway in post either 3/16" or 3mm can be specified
- Shipped fully balanced (build ready)

Ford 2.3 L EcoBoost - Heavyweight Factory Modified

Standard Features

- Guaranteed weight under 40 lbs
- Internal balance shaft drive gear removed
- Ultra-Cryo Treatment performed in house at Callies
- Keyway in post either 3/16" or 3mm can be specified
- Shipped fully balanced (build ready)



Ford 2.3 L EcoBoost Lightweight

Stroke:	Main:	Pin:	Part #
94mm	52mm	52mm	QH47BTO-FM

Ford 2.3 L EcoBoost Heavyweight

Stroke:	Main:	Pin:	Part #
94mm	52mm	52mm	QH47BTO-FH

SPORT SERIES - FORD ECOBOOST



Ford 3.5 L EcoBoost

Stroke:	Main:	Pin:	Part #
86.7mm	67mm	56mm	S24002
91.40mm	67mm	56mm	S24007

Ford 3.5 L EcoBoost Average Weight 42 lbs

Standard Features

- Stroke available 86.7 mm
- Fully Counterweighted Design
- 4340 Steel Certified by Callies in house Metallurgical Lab
- Ultra-Cryo treatment performed in house at Callies
- Ultra-Case Nitriding performed and Certified by Callies
- All journals ground with strength enhancing Tru-Form radii
- Rod & main journals finished to 4Ra or less
- Gun Drilled Mains
- Lightened Rod Journals
- Tear drop lead in main oil holes
- No Drill Internal Balance Included
- Aeroshed finishing optional

Ford 2.3 EcoBoost Ultra Enforcer Connecting Rod I-Beam

Length	Journal	Pin	Part #
5.879" / 149mm	2.166" / 52mm	0.886" / 22.5mm	U14820-3.5

Ford 3.5 EcoBoost Ultra Enforcer Connecting Rod I-Beam

Length	Journal	Pin	Part #
6.011" / 153mm	2.205" / 56mm	0.906" / 23mm	U14821-3.5

Ford 1.6 EcoBoost SS Connecting Rod H-Beam

Length	Journal	Pin	Part #
5.276" / 134mm	1.849" / 44mm	0.827" / 21mm	C24103
5.276" / 134mm	1.849" / 44mm	0.827" / 21mm	C24103-CA

Ford 2.0 EcoBoost SS Connecting Rod H-Beam

Length	Journal	Pin	Part #
6.137" / 156mm	2.166" / 52mm	0.886" / 22.5mm	C26102
6.137" / 156mm	2.166" / 52mm	0.886" / 22.5mm	C26102-CA

Ford 2.3 EcoBoost SS Connecting Rod H-Beam

Length	Journal	Pin	Part #
5.879" / 149mm	2.166" / 52mm	0.886" / 22.5mm	C26101
5.879" / 149mm	2.166" / 52mm	0.886" / 22.5mm	C26101-CA
5.925" / 150.5mm	2.166" / 52mm	0.886" / 22.5mm	C24107

C24107 = Mazda Speed Length

Ford 3.5 EcoBoost SS Connecting Rod H-Beam

Length	Journal	Pin	Part #
6.011" / 153mm	2.205" / 56mm	0.906" / 23mm	C26104
6.011" / 153mm	2.205" / 56mm	0.906" / 23mm	C26104-CA



ENERGY

MANUFACTURING

Ready to take your program to the next level? Here's why a billet block is the best choice.

Strength

Operating over 2000HP on a cast block greatly reduces the length of serviceability. Energy Manufacturing's billet block is not only an insurance for longevity but a guarantee to contain whatever additional power requirements you may necessitate.

Custom Ability

Cast blocks are constrained by the raw material available coming from the foundry, limiting head bolt and lifter position adjustments. Our billet allows for adjustments while minimizing the risk of reducing structural integrity.

Weight Reduction

Compared to a comparable cast iron block, a billet aluminum block will average approximately 60% weight reduction allotting for you to be closer to class weight minimums and/or put the weight where you want it for proper transfer.

Economical

A billet block is an investment because of the ability to repair the block multiple times and maintain the same structural integrity. Where a cast block may need to be retired, a billet block can be resold at a less depreciated value than it's cast counterpart. Remaining serviceable 3-5 times longer and maintaining resale value will allow for you to invest in other areas of your program even with the higher initial cost.

For builders selecting from our inventory components, Energy Manufacturing will be available to service your program in as little as 30 days. If you do not see the product you are looking for in the following pages, please give us a call 419-355-9304.



GEN II HEMI & WEDGE ENGINE BLOCKS

It's back! Without steady and reliable access to a **Gen II cast iron Hemi** in over a decade car enthusiasts and sportsman racer's have been left to scour scrapyards, market places, and garages to create a workable and affordable solution. Our new licensing deal with FCA group will allow you to tap into this legendary platform on demand at an affordable price.



**OFFICIAL
LICENSED
PRODUCT**

HEMI®

Gen II Cast Iron Hemi Standard Features

- Configurations Available for Order:
 - Hemi with 4.250" Finish Bore
 - Hemi with 4.500" Finish Bore
 - Hemi with 4.245" Semi Finish Bore
 - Hemi with 4.245" Semi Finish Bore, No lifter bores or pushrod clearance
 - Wedge with 4.500" Finish Bore
 - Wedge with 4.310" Semi Finish Bore
- Deck Height(s): Standard Deck: 10.725", Deck Thickness: .600"
- Camshaft: Cam Height: Standard 5.150"
- Camshaft: Housing Bore: Standard Stepped Cam Tunnel, Max Cam Housing Bore: 60mm Roller Bearing
- Cylinder Bore: Max Cylinder Bore Diameter: 4.600"
- Lifter: Lifter Diameter: .905", Lifter Angle: 45 degrees
- Main Cap Fastening: #1-4 Main Cap: (2) 1/2" Vertical Bolts, (2) 3/8" Side Bolts, #5 Main Cap: (2) 1/2" Vertical Bolts

Included with Block: Block Plug Kit, Camshaft Bearings (Loose), 0.040" Oil Gallery Restrictors (Installed), Rear Oil Seal with Fasteners.

* For available rotating assembly components see page 30 - 31.

Orders for the Gen II Cast Iron Hemi Block can be placed by calling Callies Performance Products at 419-435-2711



BILLET ALUMINUM ENGINE BLOCKS

LS Standard Features

- Deck Height(s): 9.750"
- Cylinder Bore Spacing(s): Standard
- Cylinder Bore Sizes: 4.120"-4.165", customer specified
- Cylinder Sleeve Protrusion: 0 to +.008", customer specified
- Cylinder Head Fastening per Deck: (10) 1/2-13, (4) M8x1.25, (4) 3/8" shoe kit provisions. Standard Pattern.
- Cam Height(s): Raised 0.388"
- Cam Bore Sizes: 55mm Babbitt, 55mm Roller/60mm Babbitt, or 60mm Roller. Delivered finish honed.
- Lifter Bore Configuration(s): Standard
- Lifter Bore Size(s) & Style(s): .937 bushed keyway, .937 bushed standard, or 1.060 in Aluminum ready for bushing. Delivered finish honed.
- Crank Bore(s): Standard LS. Delivered finish honed.
- Main Cap Material(s): Billet Steel
- Main Cap Fastening: (4) 1/2" Vertical Studs, (2) 7/16" side bolts, (2) 1/4" Locating dowels
- Stroke Clearance: 4.625" Max
- Timing Drive(s): Jesel Belt Drive, RCD Gear Drive, or Innovator's West Belt Drive.



LS block shown with 9.750" deck and plus .388" raised cam

Additional Information: Priority Main Oiling, Dry Only, Custom lifter and head bolt patterns available upon request.

Certain options are only available in some configurations. Please call to verify the combination you require is available

BBC Standard Features:

- Deck Height(s): 9.800", 10.200", or 10.600".
- Cylinder Bore Spacing(s): Standard
- Cylinder Bore Sizes: 4.500"-4.600", customer specified
- Cylinder Sleeve Protrusion: 0 to +.008", customer specified
- Cylinder Head Fastening per Deck: (16) 7/16-14 studs & (2) 7/16 Bolt clearance holes. Standard pattern.
- Cam Height(s): Raised 0.400" and Raised 0.600"
- Cam Bore Sizes: 55mm Babbitt, 55mm Roller/60mm Babbitt, or 60mm Roller. Delivered finish honed.
- Lifter Bore Configuration(s): Standard
- Lifter Bore Style(s) & Size(s): .937 bushed keyway, .937 bushed standard, or 1.060 in Aluminum ready for bushing. Delivered finish honed.
- Crank Bore(s): Standard BBC. Delivered finish honed.
- Main Cap Material(s): Billet Aluminum
- Main Cap Fastening: (2) 9/16" Doweled Vertical Studs, (2) 1/2" splayed studs
- Stroke Clearance: Raised 0.400: 4.750" Max, Raised 0.600: 5.250" Max
- Timing Drive(s): Jesel Belt Drive or RCD Gear Drive.



Additional Information: Priority Main Oiling, Custom Rear Cam Plug, Wide DRCE Oil Pan Pattern, Dry Only, Custom lifter and head bolt patterns available upon request.

Certain options are only available in some configurations. Please call to verify the combination you require is available

BILLET ALUMINUM ENGINE BLOCKS

SBF Standard Features:

- Deck Height(s): 9.500", 9.800", 10.000", or 10.200".
- Cylinder Bore Spacing(s): Standard
- Cylinder Bore Sizes: 4.110"-4.150", customer specified
- Cylinder Sleeve Protrusion: 0 to +.008", customer specified
- Cylinder Head Fastening per Deck: 9.800-10.200 Deck: (10) 1/2-13 studs & (4) 3/8-16 studs. Standard Pattern. Optional additional (4) 3/8-16 SC-1 inner bolt holes or (4) Energy splayed inner bolts. 9.500 Deck: (10) 1/2-13 studs, (4) 3/8 Bolt tab provision, & (4) 3/8-16 studs
- Cam Height(s): 9.500 Deck: Standard, 9.800-10.200: Raised 1.273".
- Cam Bore Sizes: 55mm Babbitt, 55mm Roller/60mm Babbitt, or 60mm Roller. Delivered finish honed.
- Lifter Bore Configuration(s): 9.500 Deck: Standard. 9.800 10.200" Decks: Custom, Cam cores in stock.
- Lifter Bore Style(s) & Size(s): Lifter Bore Style(s) & Size(s): 9.800-10.200 Deck: .937 Keyway lifter bushings, 9.500 Deck: .937 Standard lifter bushings or .937 Keyway lifter bushings
- Crank Bore(s): 351 Cleveland. Delivered finish honed.
- Main Cap Material(s): Billet Aluminum.
- Main Cap Fastening: Raised Cam Height Blocks: (2) 9/16" Doweled Vertical Studs, (2) 1/2" splayed studs. Standard Cam Height Blocks: 1 & 5 caps-(2)1/2" Vertical, (2) 3/8" Vertical 2-4 caps-(2) 1/2" Vertical, (2) 7/16" Splayed
- Stroke Clearance: 9.500" Deck: 4.250" Max, 9.800-10.200" Deck: 4.750" Max
- Supported Timing Drive(s): 9.500" Deck: Jesel Belt Drive, 9.800-10.200" Deck Jesel Belt Drive, RCD Gear Drive, or Innovator's West Belt Drive.



Additional Information: Priority Main Oiling, Wet or dry external pump only, Custom Rear Cam Plug, Raised Cam Height Blocks: Chevy Bell Housing, Enclosed Cam Tunnel, & Custom Oil Pan Pattern. Custom lifter and head bolt patterns available upon request.

***Certain options are only available in some configurations. Please call to verify the combination you require is available*
*If you want something you do not see available call to verify, we may still be able to help***

Energy Manufacturing Intake Manifolds support Energy cylinder heads. Should you want a manifold to support your current cylinder head configuration please contact us to determine if we will be able to accommodate.

Intake Manifolds

Platforms & Deck Heights

LS: 9.24 and 9.75. In Stock.

Big Block Chevy: 9.80 and 10.20. In Stock.

Small Block Ford: 9.50, 9.80, 10.00, and 10.20. In Stock.

- Throttle Bodies: Large Front Entry Oval 123mm, Single or Dual Tunnel Ram 4500 Style with or without auxiliary injectors. In Stock.
- Front Entry Manifold Fuel Rails: -8 single injector, -8 dual injector, -12 single injector, or -12 dual injector. In Stock
- Front Entry Manifold Adapters: Single 4", Single 5", Dual 3", Dual 3.5", and Dual 4". In Stock.

Additional Information: Raw Billet Aluminum or Black Anodized Finish.



BILLET ALUMINUM CYLINDER HEADS

Energy Manufacturing Cylinder Heads are machined from 6061 T6 Aluminum. They are ideal for your Boosted, Nitrous and all out competition engines with record setting performances in X275 and Outlaw radial competition.

LS 8° Billet cylinder heads

Standard Features

- Available for wet or dry applications
- Chamber Volume 43cc
- Intake Runner Volume 357cc
- Flow Numbers : Intake 449 cfm, Exhaust 284 cfm
- Intake Valve Size & Angle 2.275", 8° Canted 4°, Titanium Valves in Stock
- Exhaust Valve Size & Angle: 1.625", 0.4° Canted 2.5°, Titanium & Inconel Valves in Stock
- Seat Angle: 50°
- Head Bolt Pattern: Standard

Rockers: Aluminum Intake, Aluminum Exhaust, Steel Intake, Steel Exhaust. In Stock.

Rocker Stand: Energy Custom Stands. In Stock.

Valve Covers: Raw Aluminum or Black Anodized, Billet Aluminum, Left Blank for Custom Engraving, and O-ringed. In Stock.

Additional Information: O-ringed intake flanges, Machined for optional head saver washer inserts, 11/32" guides: bronze intake, steel exhaust, optional flame hoops.



Big Block Chevy 14.5° Billet cylinder heads

Standard Features

- Available in wet or dry configuration
- Chamber volume 84cc
- Intake Runner Volume: 410cc
- Flow Numbers : Intake 550 cfm, Exhaust 356 cfm
- Intake Valve Size & Angle: 2.480", 14.5° Canted 4°, Titanium Valves in Stock
- Exhaust Valve Size & Angle: 1.920", 6° Canted 4°, Titanium & Inconel Valves in Stock
- Seat Angle: 50°
- Head Bolt Pattern: Standard (18) BBC head bolt pattern

Rockers: Aluminum Intake, Aluminum Exhaust, Steel Intake, Steel Exhaust. In Stock.

Rocker Stand: Energy Custom Stands. In Stock.

Valve Covers: Raw Aluminum or Black Anodized, Billet Aluminum, Left Blank for Custom Engraving, and O-ringed. In Stock.

Additional Information: O-ringed intake flanges, Machined for optional head saver washer inserts, 11/32" guides: bronze intake, steel exhaust, optional flame hoops



Ford 10.5° Billet cylinder heads

Standard Features

- Available for wet or dry applications
- Chamber volume 43cc
- Intake Runner Volume 330cc
- Flow Numbers : Intake 454 cfm, Exhaust 279 cfm
- Intake Valve Size & Angle: 2.275", 10.5° Canted 2.5°, Titanium Valves in Stock
- Exhaust Valve Size & Angle: 1.625", 3° Canted 5°, Titanium & Inconel Valves in Stock
- Seat Angle: 50°
- Head Bolt Pattern: Standard with Energy or SC-1 Valley Bolt option.

Rockers: Aluminum Intake, Aluminum Exhaust, Steel Intake, Steel Exhaust. In Stock.

Rocker Stand: Energy Custom Stands. In Stock.

Valve Covers: Raw Aluminum or Black Anodized, Billet Aluminum, Left Blank for Custom Engraving, and O-ringed. In Stock.

Additional Information: O-ringed intake flanges, Machined for optional head saver washer inserts, 11/32" guides: bronze intake, steel exhaust, optional flame hoops.



HEAVY METAL

High Density Heavy Metal

Part #	Length
HMC-002	0.500 X 1.175
HMC-013	0.627 X 1.175
HMC-004	0.750 X 1.175
HMC-015	0.750 X 0.805
HMC-014	0.875 X 1.175
HMC-003-D	1.002 X 0.675
HMC-009	1.002 X 0.790
HMC-001-D	1.002 X 1.175
HMC-011-D	1.125 X 0.790
HMC-005	1.125 X 1.175
HMC-007-D	1.250 X 0.780
HMC-006-D	1.250 X 1.175
HMC016-D	1.2520 X 0.995
HMC017-D	1.2520 X 0.626
HMC018-D	1.2520 X 1.160
HMC019-D	1.0020 X 0.625
HMC020-D	1.0020 X 0.995

Callies tungsten heavy metal is machined to ease installation and produce an excellent appearing project. Our heavy metal slugs are centerless ground then precision turned and chamfered to length. The result is unmatched dimensional consistency.

A wide range of lengths are available to specifically match the variety of counterweight thickness' found on Chevy, Ford and Mopar crankshafts. Diameters from .500" up to 1.375" make locating mass exactly where it's needed much easier. High density 97% tungsten material guarantees each piece of heavy metal will yield the maximum effect.



Callies also offers precision drills and reamers, ensuring a perfect interference fit for your heavy metal installation.

Many additional custom diameters and lengths are available, we may have exactly what you need!

Callies can simplify your engine builds by providing a comprehensive offering of the highest quality engine components available. We are experts at consolidating builds into a single shipment that will arrive at your shop on time, ready for installation. **Below is a partial listing of the world class manufacturers we handle.** Let us assist you with expert advice, the latest advancements in technology and additional savings.









ULTRA ROD PART NUMBERS

Ultra Rod Part Numbers

 Ultra Chevy Part Numbers							
Chevy Small Block - I Beams							
	Std	SJ	HJ	LW	LWSJ	XD	ENFORCER
5.700	U14125						
5.850	U14130	U14131	U14132-3.5			U18130	
6.000	U14135	U14136	U14137-3.5	U14138	U14139	U18135	U18235
6.125	U14140	U14141	U14142-3.5	U14143	U14144		
6.200	U14145	U14146					U14245
6.250	U14150	U14151					
Chevy Big Block - I Beams							
	Std	SJ				XD-ENF	ENFORCER
6.385	U15110	U15117					U15210
6.535	U15111	U15118					U15211
6.660	U15113						
6.700	U15114					U18214	
6.750	U15115						
6.800	U15116						
7.100	U15270						U15275
7.200	U15280						
Small Block - H Beam							
	Std	SJ	HJ			XD	
6.000	U16100	U16101	U16102			U19135	
6.125	U16110						
6.200	U16120						
Small Block - H Beam (DIRT STYLE)							
	DIRT-Std	DIRT-SJ	DIRT-HJ		DIRT-HJ.866		DIRT-SJ HW
5.700			U16327				
5.850		U16331	U16332				U16431
6.000		U16336	U16337		U16338		
Big Block - H Beams							
	Std					XD	
6.385	U16200						
6.480	U16205						
6.535	U16210						
6.700	U16230					U19114	

 Ultra LS Part Numbers							
LS1 - I Beams							
	Std	SJ			.866 Pin	XD	ENFORCER
6.125	U17171	U17172					U17175
6.350	U17178				U17179		
LS1 - H Beams							
	Std	SJ			.866 Pin		
6.100-LW	U16290						
6.125	U16300	U16310					
6.200-LW	U16303						
6.350	U16302						
6.460	U16301						

 Ultra FORD Part Numbers				
Ford Small Block - I Beams				
	Std	SJ-.866	ENFORCER	Notes:
5.879			U14820-3.5	2.3L Ecoboost
6.011			U14821-3.5	3.5L Ecoboost
5.933	U14825			Modular
6.125		U14844-3.5		RY45
6.200	U14845	U14846	U14945	SVO
6.250	U14850	U14851		SVO
Ford Big Block - I Beams				
	Std			Notes:
6.700	U15814			
6.800	U15816			
Ford Diesel - I Beams				
	Std			Notes:
6.0L	U13100			Powerstroke
Ford - H Beams				
	Std	SJ	HJ	Notes:
5.400	U16600			
5.850	U16610	U16611	U16612	Coyote .866 Pins
6.319	U16620			Godzilla

Ultra Sport Series Part Numbers		
I Beams		
	ENFORCER	Notes:
5.590	U18100-3.5	Toyota 2JZ
5.590	U18101	Toyota 2JZ-Honda Journal
		
6.000	U15415	Nissan RB30
6.500	U15400	Nissan GTR
6.500	U15405	Nissan GTR - BB Pin
		
5.138	U16700-3.5	Subaru EJ20
5.217	U16710-3.5	Subaru EJ20+2mm
5.295	U16715-3.5	Subaru EJ20+4mm
		
5.659	U16720-3.5	Mitsubishi 4B11
150 mm	U16730	Misubishi 4G63
153 mm	U16740	Misubishi 4G63
156 mm	U16750	Misubishi 4G63
H Beams		
	Std	Notes:
5.600	U16500	Buick
		
6.500	U16510	Nissan GTR - Tapered Pin End

New in 2020

COMPSTAR ROD PART NUMBERS

Compstar Rod Part Numbers

 Compstar Chevy Part Numbers			
Chevy Small Block - H Beams (.927 Pin)			
C-Line	Std	SJ	HJ
5.700	CSA5700DS2A2AH	CSA5700CS2A2AH	
5.850	CSA5850DS2A2AH	CSA5850CS2A2AH	
6.000	CSA6000DS2A2AH	CSA6000CS2A2AH	CSA6000AS2A0AH
6.125	CSA6125DS2A2AH	CSA6125CS2A2AH	
6.200	CSA6200DS2A2AH	CSA6200CS2A2AH	
6.250	CSA6250DS2A2AH		
6.300	CSA6300DS2A2AH		

Chevy Big Block - H Beams (.990 Pin)			
C-Line	Std (1.700 Bolt)	SJ (1.545 bolt)	
6.135	CSB6135ES3B9AH		
6.385	CSB6385ES3B9AH	CSB6385DS3B9AH	
6.535	CSB6535ES3B9AH		
6.660	CSB6660ES3B9AH		
6.700	CSB6700ES3B9AH		
6.800	CSB6800ES3B9AH		

LS1 - H Beams			
C-Line	.927 Pin	.943 Pin	Note
6.100	CSC6100DS2A2AH		
6.100-SR		CSC6100DS6A2AH	Stock Replacement
6.125	CSC6125DS2A2AH		

 Chrysler - H Beams			
C-Line	.927 Pin	.990 Pin	Note
6.760		CSE6760FS3D5AH	BB Mopar
6.250	CSD6250GS2E1AH		Viper

 Compstar FORD Part Numbers			
Ford - H Beams			
C-Line	Std		
5.400	CSF5400HS2F2AH		

Compstar Sport Series Part Numbers		
H Beams		
Family	C-Line	Part #
Honda B16	5.290	C22101
Honda B18	5.433	C22102
		C22102-CA
Honda B20	5.394	C22103
		C22103-CA
Honda K24A	5.985	C22104
		C22104-CA
Honda K20A	5.472	C22105
		C22105-CA
Mitsubishi 4G63	5.906	C23101
		C23101-CA
Mitsubishi 4B11T	5.659	C23102
		C23102-CA
Mitsubishi 4G63	6.142	C23103
		C23103-CA
Mitsubishi 4G63	6.378	C23104
		C23104-CA
Ford 2.3L	5.879	C24101
		C24101-CA
Ford 2.0L	6.137	C24102
		C24102-CA
Ford 1.6L	5.276	C24103
Ford 3.5L	6.011	C24104
Ford 4.6L/5.0L	5.933	C24105
Ford 5.4L	6.657	C24106
Mazda MZR 2.3L	5.925	C24107
Nissan VQ35	5.677	C25101
Subaru EJ20	5.138	C26101
		C26101-CA
Subaru EJ20+2mm	5.217	C26102
		C26102-CA
Subaru FA20	5.091	C26103
		C26103-CA
		C27101
CanAm Maverick X3	4.606	C27101
Artic Cat Wildcat	5.000	C28101
Yamaha YXZ1000R	4.665	C29101
Polaris XP1000	4.921	C30101
Polaris XPT	4.915	C30102

ARP2000 Bolts are standard for SB-LS-Ford & Sport Series Rods

L19 Material Bolts are standard for BB Rods

"-CA" denotes sets with Custom Age 625 Bolts

Sets of 2	Sets of 3	Sets of 4
Sets of 6	Sets of 8	Sets of 10



Kalitta Racing

Top Fuel Ultra Crankshaft and Titan Camshaft



Mike Janis

Callies Ultra Billet Crankshaft



www.callies.com
2021