

VISIT *cometic.com*

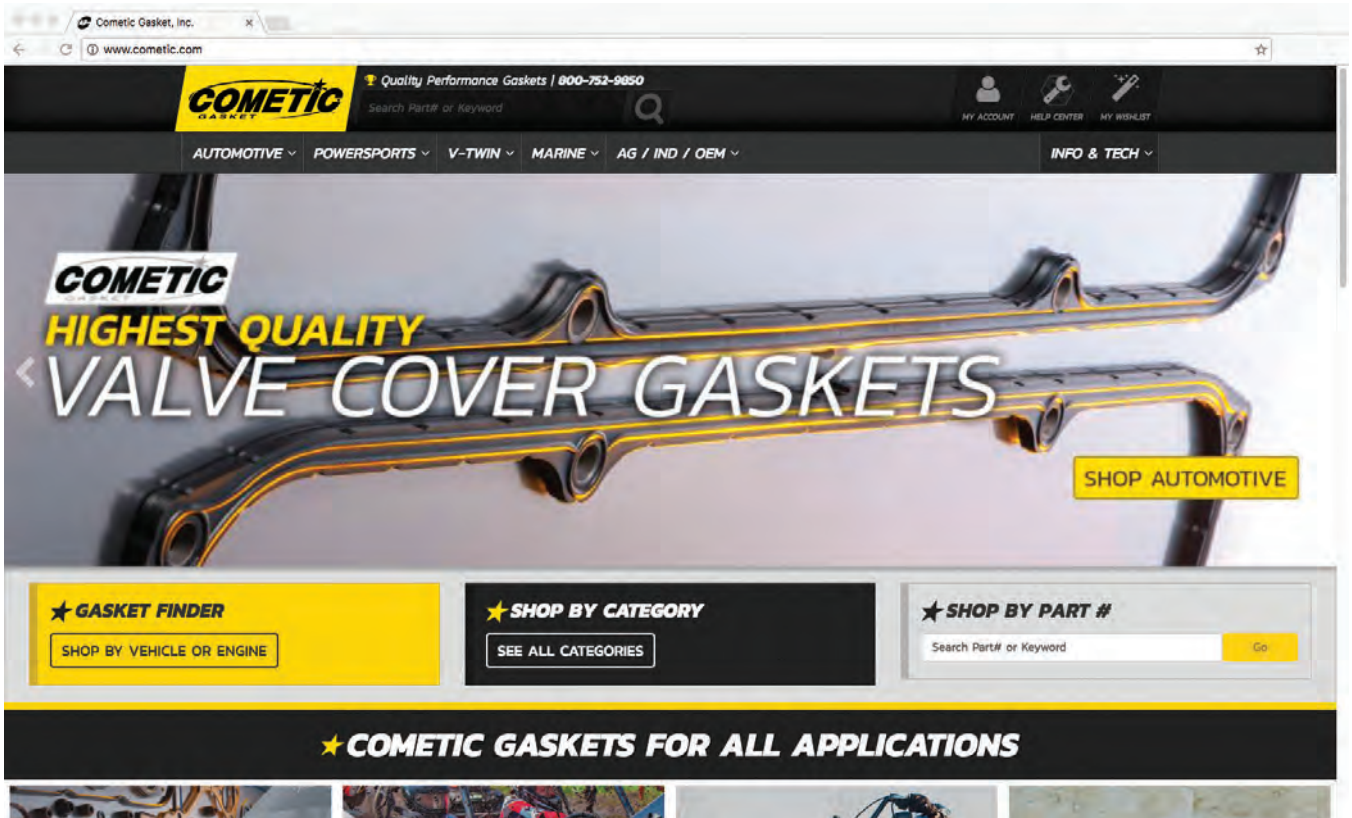

Try our
gasket finder.

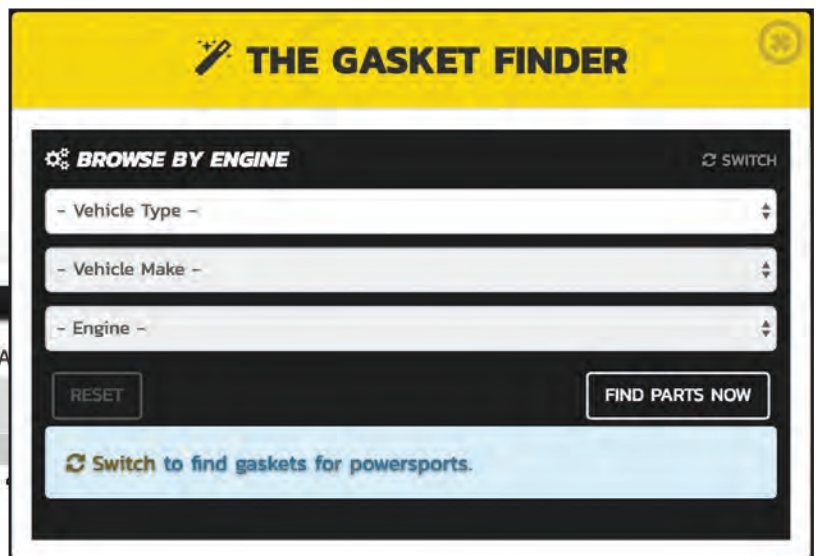

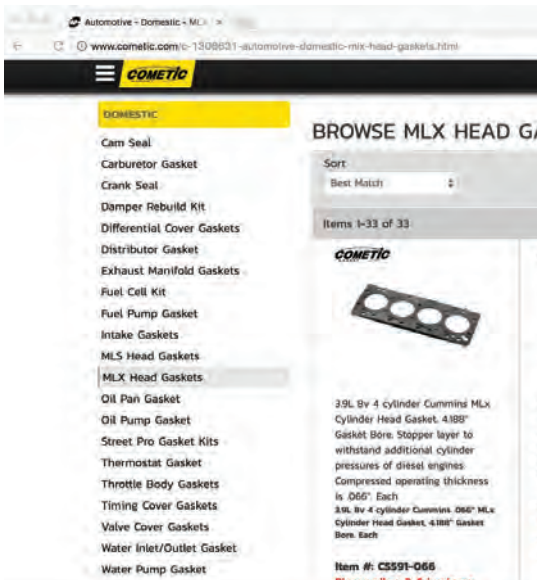

Automotive Gaskets

Cometic Gasket - An Exclusive NASCAR Performance Product

Carburetor Gaskets

Designed by engineers, validated by the winners circle. Cometic carburetor gaskets are manufactured from performance grade materials that resist swelling from various types of fuel. Can be custom ordered to your exact specifications.

Part #	Application	Material	List
C15184	HOLLEY 2 BBL CARB OPEN PLENUM	.039" FIBER	\$7.20
C5282	HOLLEY 2 BBL CARB 2 HOLE 1.750"	.047" FIBER	\$5.23
C5263	HOLLEY 4150 4BBL CARB OPEN PLENUM	.047" FIBER	\$5.73
C5262	HOLLEY 4150 4BBL 4 HOLE 1.750"	.047" FIBER	\$5.73
C15238	HOLLEY 4500 4BBL CARB OPEN PLENUM	.047" FIBER	\$8.65
C15239	HOLLEY 4500 4BBL 4 HOLE 1.750" GASKET	.047" FIBER	\$5.73
C5280	HOLLEY 390 CFM 4BBL CARB 4 HOLE 1-19/32"	.047" FIBER	\$5.73
C15181	CARTER AFB 4BBL SQUARE BORE 4 HOLE	.039" FIBER	\$7.20
C15183	ROCHESTER QUADRAJET 4BBL SPREAD BORE	.039" FIBER	\$7.20
C15240	WEBER 48MM CARB	.047" FIBER	\$3.51
C5388	HOLLEY AIRHORN CARB	.060" FIBER	\$2.97
C15241	HOLLEY FLOAT BOWL	.062" MP	\$6.51
C15242	HOLLEY 2 CIRCUIT METERING BLOCK	.062" MP	\$6.51
C15243	HOLLEY 3 CIRCUIT METERING BLOCK	.062" MP	\$6.51
C15244	HOLLEY/QUIK FUEL POWER VALVE	.062" MP	\$1.07

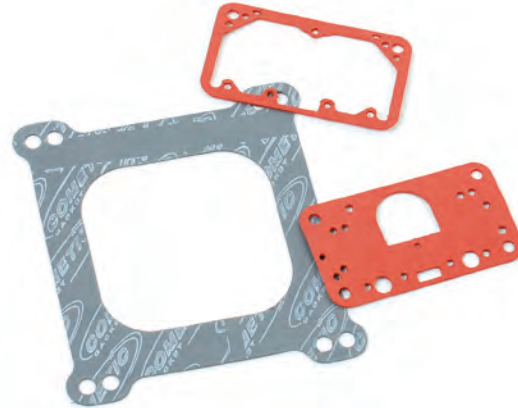

Differential Gaskets

Cometic Differential Gaskets are offered for the most popular differentials in the industry. Made from performance inspired materials and engineered to be the best sealing gasket you can find. Don't see what you are looking for? Simply send us your used gasket and we can custom make exactly what you need.

Part #	Application	Material	List
C15212	AMC 12 BOLT	.125" FIBER	\$16.43
C15213	DANA 25,27,30 10 BOLT	.032" AFM	\$13.34
C15214	DANA 35 10 BOLT	.060" AFM	\$13.34
C15215	DANA 44	.060" AFM	\$15.84
C15216	DANA 44/GM 8.75" CORVETTE/VIPER	.032" AFM	\$13.34
C15217	DANA 60/70	.060" AFM	\$20.55
C15218	DANA 80 10 BOLT	.032" AFM	\$16.43
C15219	DODGE 7.25" 10 BOLT FRONT AXLE	.032" AFM	\$14.37
C15220	DODGE 8.25" 10 BOLT REAR AXLE	.032" AFM	\$15.40
C15221	FORD 10.5" 12 BOLT	.032" AFM	\$16.43
C15222	FORD 8" 10 BOLT	.032" AFM	\$14.73
C15223	FORD 8.8" 10 BOLT	.060" AFM	\$19.52
C15224	FORD 9" 10 BOLT .040"	Formed Silicone	\$28.55
C5848-032	FORD 9" 10 BOLT	.032" AFM	\$19.52
C15225	FORD 9.75" 12 BOLT	.060" AFM	\$16.43
C15226	GM "O" AXLE 12 BOLT IRREGULAR	.060" AFM	\$14.37
C15227	GM 1/2 TON 12 BOLT	.032" AFM	\$15.40
C15228	GM 12 BOLT	.060" AFM	\$18.49
C15229	GM 7.5" 10 BOLT REAR AXLE	.032" AFM	\$14.37
C15230	GM 7.75" 9 BOLT FRONT AXLE	.032" AFM	\$15.40
C15231	GM 8.5" 1/2 & 3/4 TON 10 BOLT	.032" AFM	\$14.37
C15232	GM 8.5" 10 BOLT	.060" AFM	\$18.49
C15233	GM 9.5" 1/2 & 3/4 TON 14 BOLT	.060" AFM	\$16.43
C15234	GM TRUCK 14 BOLT	.060" AFM	\$16.43
C15235	LEGEND CAR 10 BOLT	.032" AFM	\$14.17
C15236	SPRINT MIDGET 10-BOLT QUICK CHANGE	.060" AFM	\$11.30
C15237	WINTER QUICK CHANGE 10 BOLT	.060" AFM	\$8.82

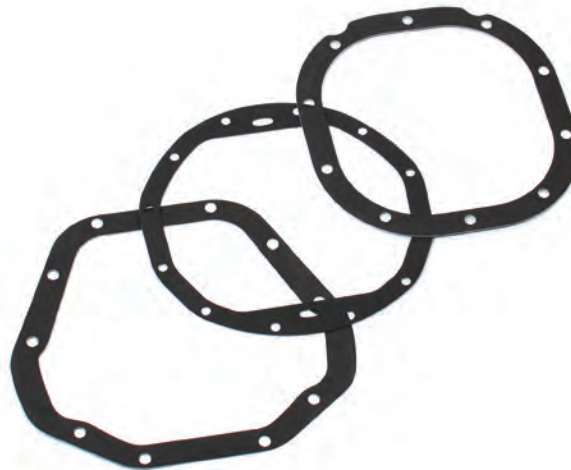

Transmission Gaskets

Why trust your expensive transmission to some flimsy paper gasket? Keep your transmission fluid and gear lube where it belongs with our Aluminum Foamet Material (AFM) Gaskets. AFM consists of an aluminum core and features a foam rubber coating bonded to both sides. Ideal for sealing less than perfect surfaces and can be installed without the use of additional sealers!

Part #	Application	Material	List
C15246	DODGE 727/46RE PAN	.060" AFM	\$22.61
C15247	FORD A4LD/4R44E/4R55E 1993-05	.060" AFM	\$22.61
C15248	FORD C-4/C-5 11 BOLT 1970-86	.060" AFM	\$22.61
C15249	FORD C-6 3 SPEED 17 BOLT	.060" AFM	\$22.61
C15250	GM 4L80E 1991-10	.060" AFM	\$22.61
C15251	GM TH700-R4/4L60E 1982-03	.060" AFM	\$22.61
C15252	GM POWERGLIDE 2SPD TRANS PAN	.075" AFM	\$22.61
C15253	GM TURBO 400 TRANS PAN	.075" AFM	\$22.61
C15254	GM TURBO 350 PAN TRANS	.075" AFM	\$22.61
C15255	MUNCIE M21 GASKET KIT - NO SEALS	AFM	\$30.84

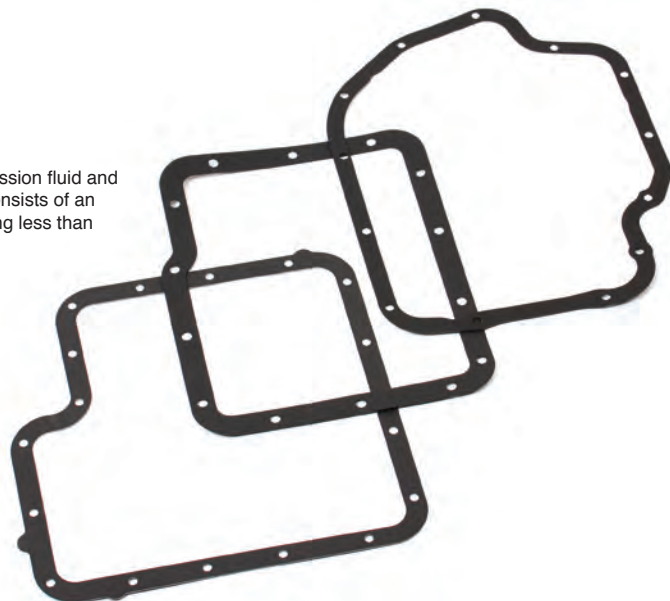

Valve Cover Gaskets & Sets

Race inspired designs and materials ensure that these valve cover gaskets will perform well above the OE standard. Cometic valve cover gaskets surpass the quality and ability of typical cork or paper gaskets offered by other manufacturers. Withstands blowing out, over tightening, and high vacuum all at an affordable price.

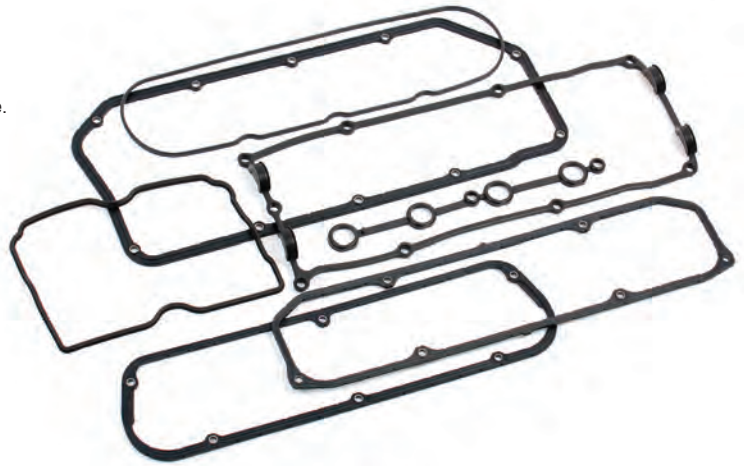

DOMESTIC

Part #	Application	List
C5976	CHRYSLER 426 HEMI V8	\$22.65
C5983	CHRYSLER BIG BLOCK WEDGE	\$22.65
C5193	CHRYSLER/DODGE 5.7/6.1L HEMI 2003+UP SET - 1 HEAD	\$16.98
C5177	FORD 4.6L DOHC 1996-98	\$67.97
C5178	FORD 4.6L SOHC 1996-04	\$45.31
C5179	FORD 4.6L SOHC 2002-04 TRUCK	\$45.31
C5974	FORD SMALL BLOCK 289,302,351W	\$16.98
C5975	GM BIG BLOCK MARK 4/5/6	\$22.65
C15245	GM LS V8 GEN III/IV 1999-14	\$22.65
C5973	GM SMALL BLOCK 18/23* V8	\$22.65
C5044	PONT 265/301/350/400/428/455	\$14.72

SPORT COMPACT

Part #	Application	List
C4643	FORD ZETEC 2.0L DOHC 1995-97 / SET	\$28.31
C4644	FORD ZETEC 2.0L DOHC 1998-04 / SET	\$28.31
C4653	FORD 2300 2.3L SOHC 1974-93 / SET	\$22.65
C4701	HONDA 1.5L 4 CYL 88-95 / SET	\$31.71
C4628	HONDA B16A2/3 & B18C1/C5 94-01 / SET	\$22.65
C4665	HONDA D16Y5/7/8 96-00 / SET	\$22.65
C4655	HONDA D16Z6 VTEC 92-95 / SET	\$28.31
C4706	HONDA DOHC 1.6L 86-89 / SET	\$31.71
C4679	HONDA/ACURA B18A1/B1 1990-01 / SET	\$22.65
C4781	MAZDA B6 1.6L 1989-93 / SET	\$22.65
C4788	MAZDA MX-6 FS-DE 2.0L 91-97 / SET	\$28.31
C4722	MITSUBISHI DOHC 24V 3.0L 91-00 / SET	\$45.31
C4691	MITSUBISHI ECLIPSE 2.0L 89-94 / SET	\$38.51
C4713	MITSUBISHI GALANT SOHC 24V 3.0L 88-96 / SET	\$28.31
C15046	MITSU/DODGE 2.0L 420A 95-99 / SET	\$22.65
C4607	NISSAN CA18DE/DET 1989-1993 / SET	\$22.65
C4906	NISSAN E15T 1.5L SOHC 1983-84 / SET	\$16.98
C4631	NISSAN KA24DE 2.4L 1993-01 FWD / SET	\$28.31
C4761	NISSAN KA24DE 2.4L DOHC 1991-94 / SET	\$22.65
C4766	NISSAN KA24DE 2.4L DOHC 1995-98 / SET	\$22.65
C4552	NISSAN RB20/25/26 1988-02 / SET	\$33.98
C4730	NISSAN SR16/20VE 1.6L 1997-01 / SET	\$39.64
C4747	NISSAN SR20DE 2.0L DOHC 1991-96 FWD / SET	\$28.31
C4753	NISSAN SR20DET S13 DOHC 88-93 / SET	\$22.65
C4755	NISSAN SR20DET S14 DOHC 94-98 / SET	\$22.65
C4773	NISSAN VG30DE 3.0L V6 90-99 / SET	\$28.31
C4871	SUBARU EJ22E SOHC 90-96 / SET	\$31.71
C4880	SUBARU EJ255 DOHC 06-07 / LEFT	\$22.65
C4881	SUBARU EJ255 DOHC 06-07 / RIGHT	\$22.65

SPORT COMPACT Part

Part #	Application	List
C4873	SUBARU EJ25D DOHC 96-99 / SET	\$45.31
C4863	SUBARU WRX EJ205 02-05 / RIGHT	\$31.71
C4864	SUBARU WRX EJ205 02-05 / LEFT	\$31.71
C4642	SUBARU EJ25 SOHC 1999-05 / SET	\$33.98
C4928	SUBARU EJ257 DOHC 2004-06 / LEFT	\$22.65
C4929	SUBARU EJ257 DOHC 2004-06 / RIGHT	\$22.65
C4935	TOYOTA 22R/RE/REC 81-85 / SET	\$16.98
C4830	TOYOTA 2RZ-FE 2.4L 4 CYL 95-02 / SET	\$22.65
C4807	TOYOTA 4A-GE 1.6L 84-92 / SET	\$18.12
C4820	TOYOTA 5S-FE 2.2L 4 CYL 90-97 / SET	\$26.05
C4851	TOYOTA SUPRA 2JZ-GE/GTE 93-97 / SET	\$33.98
C4838	TOYOTA SUPRA 7M-GTE 87-92 / SET	\$22.65
C4608	TOYOTA 3S-GTE 1991-1995 / SET	\$37.38

DIESEL

Part #	Application	List
C15056	CUMMINS 3.9L 4BT 4CYL DIESEL / SET	\$22.65
C5614	CUMMINS 5.9L 24V DIESEL 1998.5-02 / SET	\$45.31
C15066	CUMMINS 5.9L 12V DIESEL 1992-98 / SET	\$39.64
C15070	CUMMINS 5.9L 24VCR DIESEL 2003-07 / SET	\$39.64
C15143	FORD 6.0L POWERSTROKE 2003-08 / SET	\$22.65
C15151	FORD 6.4L POWERSTROKE 2008-10 / SET	\$33.98
C15162	FORD 7.3L POWERSTROKE 1994-97 / EACH	\$56.64
C15163	FORD 7.3L POWERSTROKE 1998-02 / EACH	\$79.30

Turbo Gaskets

Manufactured from a high grade stainless steel, these turbocharger gaskets get the job done the first time! The embossed spring steel maintains a torque set and won't burn through or push out. Does not require additional sealers.

Part #	Application	List
C4514	TURBO INLET FLANGE T3 GARRETT	\$9.05
C4515	TURBO INLET FLANGE T25 GARRETT	\$9.05
C4516	TURBO INLET FLANGE T4 GARRETT	\$9.05
C4513	TURBO INLET FLANGE T4 DIVIDED	\$9.05
C4517	TURBO INLET FLANGE T6 GARRETT	\$9.05
C5723-030	SUBARU WRX TURBO TO UP PIPE	\$9.05
C5736-030	SUBARU WRX TURBO TO DOWNPIPE	\$9.05
C15154	FORD 6.4L POWERSTROKE 2008-10	\$9.05



Valve Stem Seals

New age engine builds require new age valve stem seals and we have them! These viton steel body (VSB) seals are available for most applications ranging from automotive to off road dirt bikes. Sold in packs of 16. [See page 145 for additional Valve Stem Seals](#)

Part#	Valve Stem O.D.	Guide O.D.	Height	Overall O.D.	List
3225V-16	6mm	11mm	9.3mm	13.4mm	\$25.50
3262V-16	7mm	11mm	9.5mm	14.4mm	\$27.25
3516P-16	8mm	.492"	.470"	.616"	\$26.56
3237V-16	5/16"	.500"	.517"	.562"	\$25.88
3235V-16	5/16"	.531"	.516"	.677"	\$31.19
3188V-16	11/32"	.500"	.531"	.623"	\$28.97
3228V-16	11/32"	.530"	.527"	.674"	\$32.73
3195V-16	3/8"	.500"	.531"	.623"	\$27.59
3198V-16	3/8"	.625"	.531"	.742"	\$31.19





Made in the U.S.A.

TABLE OF CONTENTS

MLS

Multi Layer Steel

MLS Gaskets are comprised of multiple embossed layers of both AMP (Advanced Multi-Polymer Coating) and uncoated stainless steel. The embossed outer layers of the gaskets meet the demands of a variety of harsh sealing environments, load conditions and surface finishes. Requires less clamp load creating less bore distortion and conforms load distribution across the sealing area. The center or shim layer is an uncoated stainless steel layer which can be varied to accommodate multiple thickness requirements.

No sealants or re-torque required.



3 Layer MLS Style Cross Section

Available thickness:

.027", .030", .036", .040", .045", .051", .056", .060", .066", .070", .075", .080", .086", .092", .098", 120", .140"

MLS Head Gaskets

Make	Pg.
Austin	67
AMC	5
BMW	67
Buick	6
Cadillac	7
Chevrolet	8
Chevrolet Diesel	24
Chrysler/Dodge	25
Coventry Climax	73
Cummins Diesel	39
Ecotec 4 Cylinder	8, 80
Ferrari	74
Fiat/Lancia	74
Ford	44
Ford Diesel	61
Ford/Lotus/Cosworth	74
Honda/Acura	81
Hyundai	92
Jaguar	92
LSJ Ecotec 2.0L	8, 79
Mazda	96
Mercedes Benz	99
MG	100
Mini	100
Mitsubishi	101
Nissan	104
Oldsmobile	65
Peugeot/Citroen	120
Pontiac	66
Porsche	120
Renault	122
Rover	122
Saab	123
Subaru	123
Toyota	135
Triumph	145
TVR	146
Vauxhall/Opel	146
VW/Audi	147
Volvo	148
3.6L LY7/LLT/LFX	10

COPPER Head Gaskets

Make	Pg.
Buick V6 192-231-252 Stage I & II	6
GM / Chevy 18/23 Degree Small Block	11
GM / Chevy LS	15
GM / Chevy LSX / LHS	18
GM / Chevy Big Block MK4	20
Chrysler 318-360 LA	28
Chrysler 383-440 Wedge	35
Chrysler Early Hemi 354-392	36
Chrysler 426 Hemi	37
Ford Non SVO 260-351W	54
Ford 429-460	60

MLX

Multi Layer Xtreme

MLX Gaskets utilize an integrated "stopper" layer for combustion chamber sealing and improved clamp load around the cylinder without increasing bore distortion. MLX technology can be found in the applications below and are made from the same materials as our MLS Head Gaskets.

No sealants or re-torque required.



3 Layer MLx Style Cross Section



4 Layer MLx Style Cross Section



5 Layer MLx Style Cross Section

MLX Head Gaskets

Application	Pg.
4.2L Inline 6 LL8 Vortec 4200	11
Vortec 4200 LL8, 18/23 Degree SBC	11
SBC w/All Pro Heads, Dart/Brodix	13
Chevy R07.2	14
LS1/LS2/LS3/LS6	15
LS7, LS9/LSA	17
LS Next Block, LSX	18
LT1 6.2L	19
Big Block V8	21
GM 5.2 Prostock	23
6.6L Duramax	24
5.7L Hemi	30
6.1L Hemi	31
6.2L Hellcat, 6.4L Apache, 7.0L Drag Pack	32, 33
Chrys/Dodge R6 V8	34
8.0/8.3L V10, 8.4L V10	38
Cummins 4BT	39
Cummins 6BT 12v	40
Cummins ISB 24v	41
Cummins 5.9L CR	42
Cummins 6.7L	43
Ford 1.6L Sigma	44, 74, 80
Ford 3.5L EcoBoost	48
Ford 4.6/5.4L SOHC/DOHC	49
Ford 5.0L Coyote	51
Ford 5.8L Trinity V8	52
Ford 302/351	54
Ford New Boss 302 Block	56
Ford FR9 V8	57
Ford 6.0L Powerstroke	61
Ford 6.4L Powerstroke	63
Ford 6.7L Scorpion, 7.3L Powerstroke	64
Honda/Acura K20/24	89
Hyundai 2.0L & 3.8L DOHC V6	92
Jaguar AJ133 5.0L	96
Mazda MZR 2.3L DOHC	99
Mini 1.6L Turbo Prince	100
Mitsu EVO X 4B11T	101
Mitsu 2.0L 4G63/4G63T	102
Mitsu 2.0L 4B11T	103
Mitsu 3.0L 6G72	104
Nissan 2.0L SR20DE/DET S14	109
Nissan GT-R VR38DETT	118
Nissan TB48DE, VK56DE 5.6L	119
Nissan	119
Rover 5.0L V8 LR-V8	123
Subaru FA20, EJ205	124
Subaru EJ22E	125
Subaru EJ25D DOHC	127
Subaru EJ251/EJ253	128
Subaru EJ255	129
Subaru EJ257	131
Toyota 2ZZ-GE 1.8L	137
Toyota 1FZ-FE 4.5L	144
Vauxhall 16V, Volkswagen/Audi 1.4l	146

STREETpro

Top & Bottom End Gasket Kits

StreetPro is a product line of Comet Gasket manufactured by Comet Gasket. Geared toward the street rodder who is looking to purchase a kit with all necessary gaskets and seals needed for your rebuild.

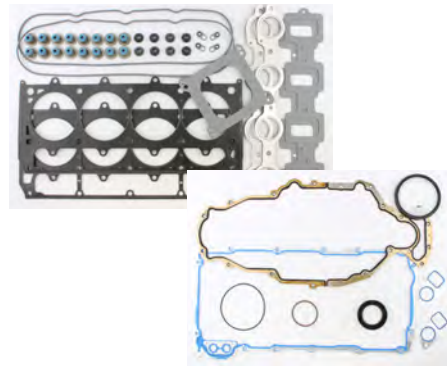

STREET PRO KITS

Make	Pg.
BMW	68, 70
Buick	7
Chevrolet	10, 12, 16, 19, 21, 25
Chevrolet Diesel	24
Chrysler/Dodge	26, 29, 31, 32, 35, 36, 37
Cummins	40, 41, 42, 43, 44
Ford	46, 47, 50, 53, 55, 59, 60, 62, 63
Ford Diesel	61, 62, 63, 64
Ford/Lotus	78, 79
Honda/Acura	81, 82, 83, 85, 86, 87, 88
Mazda	97, 98
Mitsubishi	101, 103, 104
Nissan	106, 107, 108, 109, 110, 111, 112, 113, 115, 116, 117
Oldsmobile	65
Pontiac	66
Subaru	125, 126, 127, 128, 130, 131, 132, 133
Toyota	136, 137, 139, 140, 142, 143

Miscellaneous Gaskets & Accessories

Application	Pg.
Molded Rubber Valve Cover Gaskets	3
MLS Exhaust Gaskets	149
Valve Stem Seals	3, 150
2PC Rear Main Seals	151
Rear End Gaskets	2
Carburetor Gaskets	2
Fuel Cell Gasket Kit	151
High Vacuum Crank Seals	151
Turbo Gaskets	3
Timing Cover Sets	151
Damper Rebuild O-rings	151
Cometic Block & Head Cleaner	152
Klotz Lubricants	152
Transmission Gaskets	2
UTV Gaskets	153
Fasteners	156



Cometic Gasket - An Exclusive NASCAR Performance Product

AMC

4.0L Inline 6 242ci 1987-2006

87-01 Cherokee, 93-04 Grand Cherokee, 87-90 Wagoneer, 87-92 Comanche, 91-06 Wrangler

Head Gaskets

MLS Head Gaskets

Bore	Thickness	Pkg Qty	Part #	List Price
3.950	.050"	1	C5987-050	\$119.96
4.000	.050"	1	C5988-050	\$119.96
4.060	.050"	1	C5989-050	\$119.96

Additional thicknesses available see page 4

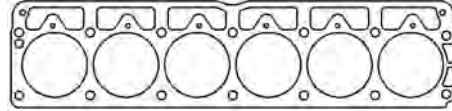

Individual Gaskets

Timing Cover Set

Application	Part #	List Price
3.8/4.0/4.2L I6 1965-2006	C5047	\$16.98

290-401ci V8

Head Gaskets

MLS Head Gaskets

Fits: 290 1966-69, 304 1970-78, 343 1967-69, 360 1970-91

Bore	Thickness	Pkg Qty	Part #	List Price
3.810"	.040"	1	C5669-040	\$98.23
4.140"	.040"	1	C5674-040	\$98.23

Additional thicknesses available see page 4

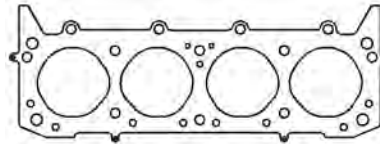

MLS Head Gaskets

Fits: 390 1970 & 401 1972-74

Bore	Thickness	Pkg Qty	Part #	List Price
4.250"	.040"	1	C5937-040	\$98.23
4.380"	.040"	1	C5938-040	\$98.23

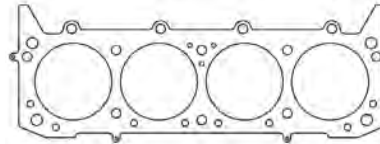

NEW!

MLS Head Gaskets

Fits: INDY 401 Aluminum Heads

Bore	Thickness	Pkg Qty	Part #	List Price
4.380"	.040"	1	C5409-040	\$98.23
4.380"	.080"	1	C5409-080	\$136.33

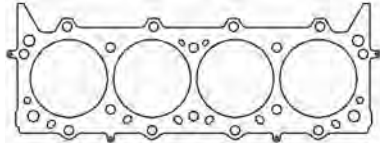

Individual Gaskets

Exhaust Gasket Set

Application	Part #	List Price
304-401ci w/Dogleg Ports	C5161-064	\$25.94
304-401ci w/Rectangle Ports	C5101-064	\$25.94

Intake Gasket Set

Application	Part #	List Price
290-401 V8 1970-91 1.13" x 2.22"	C15002-060	\$29.41
390/401 Indy Head 1.20" x 2.30"	C15003-060	\$29.41

Valve Cover Gasket (sold individually)

Application	Part #	List Price
390/401ci V8 Indy Head	C5115-188	\$16.59

Timing Cover Set

Application	Part #	List Price
290-401ci V8 1966-88	C5046	\$16.98



Cometic Gasket - An Exclusive NASCAR Performance Product

BUICK

192, 231, 252ci V6 Stock, Stage I, and Stage II

Head Gaskets

MLS Head Gaskets

Bore	Thickness	Pkg Qty	Part #	List Price
3.860"	.040"	1	C5691-040	\$89.49
4.020"	.040"	1	C5692-040	\$89.49
4.090"	.040"	1	C5693-040	\$89.49

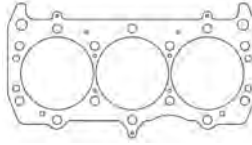

Additional thicknesses available
see page 4

NEW!

Copper Head Gaskets

Bore	Thickness	Pkg Qty	Part #	List Price
3.860"	.043"	1	C15407-043	\$99.99

Individual Gaskets

Exhaust Gasket Set

Application	Part #	List Price
Stock & Stage I Ports	C5696-064	\$28.92
Stage II Ports	C5791-064	\$28.92

Valve Cover Gasket (sold individually)

Application	Part #	List Price
Iron & Aluminum Heads	C5697-188	\$16.59

Intake Gasket Set

Application	Part #	List Price
Stock & Stage I Ports	C5694-060	\$25.25
Stage II Ports	C5792-060	\$28.92

Timing Cover Set

Application	Part #	List Price
66-87 V6/Small V8 w/Rope Seal	C5048	\$22.65
66-87 V6/Small V8 w/Radial Seal	C5049	\$16.98

Oil Pan Gasket

Application	Part #	List Price
20 Bolt	C5700-094	\$23.30

Rear Main Seal

Application	Part #	List Price
2 Piece w/Side Rails	C5707	\$18.27

3800 Series II V6 1996-2003

Head Gaskets

MLS Head Gasket - Left Side

Bore	Thickness	Pkg Qty	Part #	List Price
3.840"	.066"	1	C5720-066	\$136.33

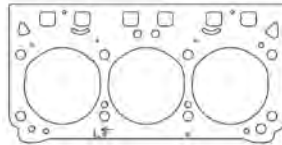

Additional thicknesses available
see page 4

MLS Head Gasket - Right Side

Bore	Thickness	Pkg Qty	Part #	List Price
3.840"	.066"	1	C5721-066	\$136.33

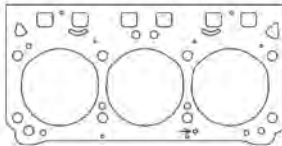



Cometic Gasket - An Exclusive NASCAR Performance Product

BUICK

400, 430 & 455 V8 - All Years

Head Gaskets

MLS Head Gaskets				
Bore	Thickness	Pkg Qty	Part #	List Price
4.312"	.040"	1	C5753-040	\$100.67
4.385"	.040"	1	C5754-040	\$100.67
4.400"	.040"	1	C5755-040	\$100.67

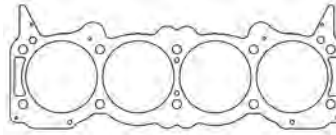

Additional thicknesses available see page 4

Individual Gaskets

Exhaust Gasket Set		
Application	Part #	List Price
All Years	C5776-064	\$30.65

Valve Cover Gasket (sold individually)		
Application	Part #	List Price
All Years	C5774-094	\$11.74

Intake Gasket Set		
Application	Part #	List Price
1967-71 1.172" x 2.453" Port.....	C5143-060	\$28.13
1972-76 1.156" x 2.420" Port.....	C5775-060	\$29.51

Timing Cover Set		
Application	Part #	List Price
1967-76 Water Pump Gasket.....	C5144-031	\$10.76
1970-76 455 Water Outlet Gasket.....	C15004-031	\$1.95

Oil Pan Gasket		
Application	Part #	List Price
1967-76 4pc Set.....	C5145	\$26.87

Timing Cover Set		
Application	Part #	List Price
67-74 400, 430, 455 V8.....	C5050	\$16.98

Gasket Kits

To purchase a complete gasket kit order both top end and bottom end gasket kit

TOP END GASKET KIT

BOTTOM END GASKET KIT

Application	Part #	List Price
Big Block 455ci 1970-76 4.385" Bore.....	PRO1011T	\$195.69

Application	Part #	List Price
Big Block 455ci 1970-76.....	PRO1011B	\$33.05

CADILLAC

Northstar 4.6L 32v V8 1993-2011

Head Gaskets

MLS Head Gasket - Left Side				
Bore	Thickness	Pkg Qty	Part #	List Price
3.700"	.066"	1	C5717-066	\$147.34

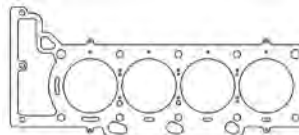

Additional thicknesses available see page 4

See page 8 for additional gaskets



Cometic Gasket - An Exclusive NASCAR Performance Product

CADILLAC

Northstar 4.6L 32v V8 1993-2011

Head Gaskets

MLS Head Gasket - Right Side

Bore	Thickness	Pkg Qty	Part #	List Price
3.700"	.066"	1	C5716-066	\$147.34

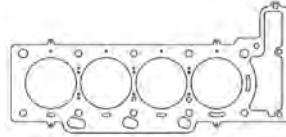

Additional thicknesses available see page 4

CHEVROLET / GM

ECOTEC 4 Cylinder

Head Gaskets

MLS Head Gasket - LSJ 2.0L

Bore	Thickness	Pkg Qty	Part #	List Price
87mm	.027"	1	C5921-027	\$98.23

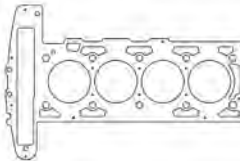

Additional thicknesses available see page 4

MLX Head Gasket - LSJ 2.0L

Bore	Thickness	Pkg Qty	Part #	List Price
87mm	.040"	1	C5032-040	\$136.33

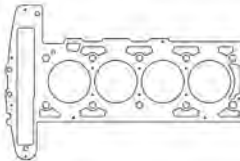

MLX Head Gasket - LNF 2.0L 08-10

Bore	Thickness	Pkg Qty	Part #	List Price
88mm	.032"	1	C15256-032	\$136.33

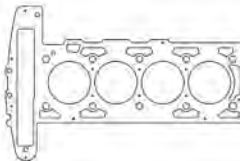

MLX Head Gasket - LTG 2.0L DOHC

Bore	Thickness	Pkg Qty	Part #	List Price
87mm	.028"	1	C4964-028	\$136.33

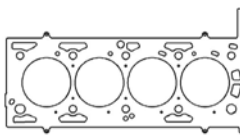

MLS Head Gaskets - L61/L42 2.2L DOHC

Bore	Thickness	Pkg Qty	Part #	List Price
87mm	.040"	1	C5768-040	\$98.23
89mm	.040"	1	C5804-040	\$98.23

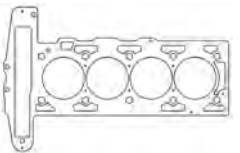

Individual Gaskets

MLS Exhaust Gasket

Application	Part #	List Price
2000-2009 2.2/2.4L	C4150-030	\$23.74

2.2L 134ci "LN2": Cavalier/Sunfire FWD 1998-02, S-10/Sonoma RWD 1994-03

Head Gaskets

MLS Head Gaskets

Bore	Thickness	Pkg Qty	Part #	List Price
90mm	.030"	1	C5914-030	\$98.23
93mm	.030"	1	C5915-030	\$98.23

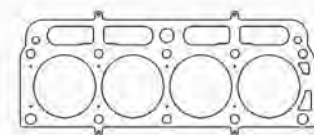

Additional thicknesses available see page 4



Cometic Gasket - An Exclusive NASCAR Performance Product

CHEVROLET / GM

2.4L 146ci "LD9" Twin Cam 1996-2001

Head Gaskets

MLS Head Gasket - 1996-99 w/EGR				
Bore	Thickness	Pkg Qty	Part #	List Price
3.595"	.030"	1	C5298-030	\$98.23

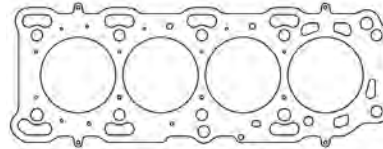

Additional thicknesses available
see page 4

MLS Head Gaskets - 1999-01 w/o EGR				
Bore	Thickness	Pkg Qty	Part #	List Price
3.595"	.030"	1	C5866-030	\$98.23
3.595"	.075"	1	C5866-075	\$136.33

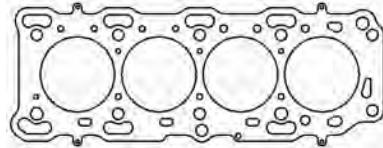

2.5L 153ci 1965-1979/3.0L VORTEC 3000 (Marine)

Head Gasket

MLS Head Gasket				
Bore	Thickness	Pkg Qty	Part #	List Price
4.100"	.045"	1	C5956-045	\$89.49

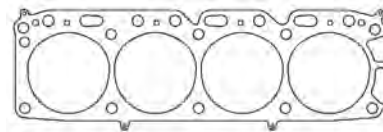

Additional thicknesses available
see page 4

3.1/3.4/3.9L 60 Degree V6

Head Gaskets

MLS Head Gasket - 3.1L 1993-99				
Bore	Thickness	Pkg Qty	Part #	List Price
91mm	.051"	1	C5220-051	\$96.70

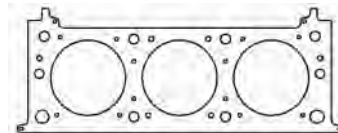

Additional thicknesses available
see page 4

MLS Head Gasket - 3.4L 1993-05				
Bore	Thickness	Pkg Qty	Part #	List Price
95mm	.051"	1	C5266-051	\$96.70

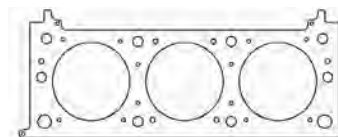

MLS Head Gasket - 3.9L 2006-11 Left Side				
Bore	Thickness	Pkg Qty	Part #	List Price
101mm	.051"	1	C5226-051	\$96.70

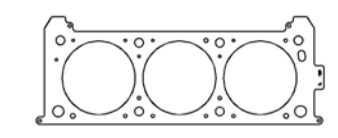

MLS Head Gasket - 3.9L 2006-11 Right Side				
Bore	Thickness	Pkg Qty	Part #	List Price
101mm	.051"	1	C5227-051	\$96.70

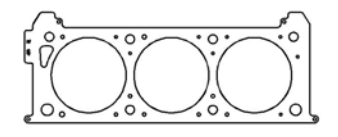

Individual Gaskets

Exhaust Gasket Set		
Application	Part #	List Price
1993-05 3.1/3.4L V6	C15005-064	\$19.71



Cometic Gasket - An Exclusive NASCAR Performance Product

CHEVROLET / GM

3.6L LY7/LLT/LFX V6 2004-Present

Head Gaskets

MLX Head Gasket - Left Side

Bore	Thickness	Pkg Qty	Part #	List Price
98mm	.044"	1	C5029-044	\$96.70

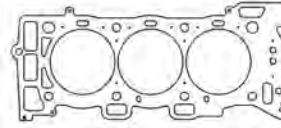

Additional thicknesses available see page 4

MLX Head Gasket - Right Side

Bore	Thickness	Pkg Qty	Part #	List Price
98mm	.044"	1	C5028-044	\$96.70

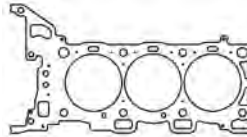

4.3L 229/262ci 90 Degree V6 1985-2009

Head Gaskets

MLS Head Gaskets

Bore	Thickness	Pkg Qty	Part #	List Price
4.060"	.040"	1	C5739-040	\$98.23
4.120"	.040"	1	C5740-040	\$98.23
4.155"	.040"	1	C5741-040	\$98.23

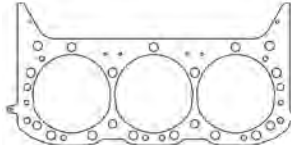

Additional thicknesses available see page 4

Individual Gaskets

Valve Cover Gasket (sold individually)

Application	Part #	List Price
4.3L V6 .188" ML Material	C15006-188	\$16.59

Timing Cover Set

Application	Part #	List Price
1985-95 w/Thick Front OP Seal	C5051	\$16.98

Intake Gasket Set

Application	Part #	List Price
4.3L V6 .060" Fiber	C15007-060	\$29.00

Water Pump Gasket

Application	Part #	List Price
.018" AFM Material	C5299-018	\$0.70

Exhaust Gasket Set

Application	Part #	List Price
1985-92 4.3L V6 .064" AM	C15008-064	\$19.71

Oil Pan Gasket

Application	Part #	List Price
4 Piece Set	C5496	\$26.99

Fuel Pump Mounting Gasket

Application	Part #	List Price
1985-96 4.3L V6 .020" Fiber	C15009-020	\$2.27

Rear Main Seal Kit

Application	Part #	List Price
1 Piece Design	C5106	\$26.99

Gasket Kits



To purchase a complete gasket kit order both top end and bottom end gasket kit

TOP END GASKET KIT



Application	Part #	List Price
4.3L V6 1985-93 4.120" Bore	PRO1006T	\$170.97

BOTTOM END GASKET KIT



Application	Part #	List Price
4.3L V6 1985-93	PRO1006B	\$55.09



Cometic Gasket - An Exclusive NASCAR Performance Product

CHEVROLET / GM

194, 230, 250, 292 Inline 6 1962-84

Head Gaskets

MLS Head Gasket				
Bore	Thickness	Pkg Qty	Part #	List Price
4.125"	.040"	1	C5699-040	\$175.38

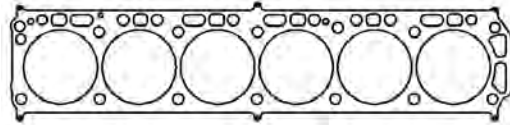

Individual Gaskets

Intake/Exhaust Gasket Set		
Application	Part #	List Price
292 I6 Intake .059" CFM	C15010-059	\$54.01

Timing Cover Set		
Application	Part #	List Price
4/6 Cyl 151/230/250/292	C5053	\$16.98

4.2L Inline 6 "LL8" Vortec 4200 2002-09

Head Gaskets

NEW!

MLX Head Gasket				
Bore	Thickness	Pkg Qty	Part #	List Price
3.710"	.040"	1	C15374-040	\$188.24

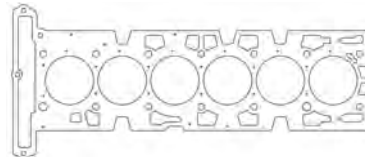

18/23 Degree Small Block V8 262-400ci (*has steam holes)

Head Gaskets

MLS Head Gaskets - Round Bore				
Bore	Thickness	Pkg Qty	Part #	List Price
4.060"	.040"	1	C5245-040	\$89.49
4.100"	.040"	1	C5246-040	\$89.49
4.125"	.040"	1	C5247-040*	\$89.49
4.165"	.040"	1	C5248-040*	\$89.49
4.200"	.040"	1	C5249-040*	\$89.49

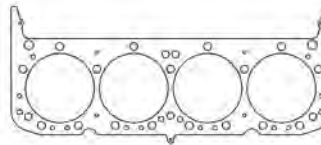

MLS Head Gaskets - Valve Pocketed Bore				
Bore	Thickness	Pkg Qty	Part #	List Price
4.060"	.040"	1	C5269-040	\$89.49
4.100"	.040"	1	C5270-040	\$89.49
4.125"	.040"	1	C5271-040*	\$89.49
4.165"	.040"	1	C5272-040*	\$89.49
4.200"	.040"	1	C5273-040*	\$89.49

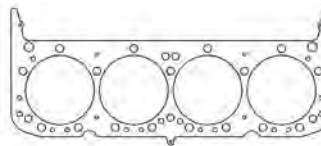

MLX Head Gaskets - Round Bore				
Bore	Thickness	Pkg Qty	Part #	List Price
4.165"	.040"	1	C5031-040	\$115.07
4.220"	.040"	1	C5786-040	\$115.07

NEW!

Copper Head Gaskets - Round Bore				
Bore	Thickness	Pkg Qty	Part #	List Price
4.165"	.043"	1	C15411-043	\$112.13

NEW!

Copper Head Gaskets - Valve Pocketed Bore				
Bore	Thickness	Pkg Qty	Part #	List Price
4.200"	.043"	1	C15412-043	\$112.13



Cometic Gasket - An Exclusive NASCAR Performance Product

CHEVROLET / GM

18/23 Degree Small Block V8 262-400ci

Individual Gaskets

Valve Cover Gaskets (sold individually)

Application	Part #	List Price
18/23° Molded Rubber.....	C5973	\$22.65
Splayed Valve Heads	C5390-094	\$19.71

Oil Pan Gasket Kit

Application	Part #	List Price
1955-79 LH Dipstick 4pc Kit.....	C5295-094	\$33.15
1980-85 RH Dipstick 4pc Kit.....	C5294	\$33.15
1986-97 1 pc Molded Rubber.....	C5072	\$37.09

Intake Gasket Set

Application	Part #	List Price
18° Heads 1.35" X 2.25" Port.....	C5541-060	\$29.41
23° Heads 1.24" X 1.97" Port.....	C5544-060	\$29.41
23° Heads 1.24" x 2.10" Port.....	C5545-060	\$29.41
23° Heads 1.28" x 2.17" Port.....	C5528-060	\$29.41
305/350 w/TPI 85-92 Set.....	C15198	\$35.01
China Rail Gaskets.....	C5536-060	\$6.17

Exhaust Gasket Set

Application	Part #	List Price
18° 1.50" x 1.47" .064" AM.....	C5314-064	\$35.63
23° 1.45" x 1.48" .030" MLS.....	C5892-030	\$41.04
23° 1.50" Round .030" MLS.....	C5891-030	\$41.04
23° 1.45" x 1.60" .030" MLS.....	C5894-030	\$42.13
23° 1.625" Round .030" MLS.....	C5893-030	\$42.13
23° 1.55" x 1.45" .030" MLS.....	C15190-030	\$40.16

Timing Cover Set

Application	Part #	List Price
1957-74 w/Thin Front OP Seal.....	C5052	\$16.98
1975-95 w/Thick Front OP Seal.....	C5051	\$16.98

Fuel Pump Mounting Gaskets

Application	Part #	List Price
2 Bolt - .032" AFM.....	C5389-032	\$1.79
4 Bolt - .032" AFM.....	C15012-032	\$1.79

Water Pump Gaskets

Application	Part #	List Price
Water Pump MTG Gasket	C5299-018	\$0.70
Water Pump Backing Plate Gasket	C15011-032	\$6.05

Rear Main Seal Kit

Application	Part #	List Price
2 Piece Viton	C5680	\$24.54
1 Piece Viton	C5106	\$26.99

Individual Gaskets

Thermostat Gasket

Application	Part #	List Price
.047" Fiber	C5538-047	\$1.13

Distributor Gasket

Application	Part #	List Price
.060" Fiber	C5531-060	\$1.30

Gasket Kits



To purchase a complete gasket kit order both top end and bottom end gasket kit

TOP END GASKET KIT

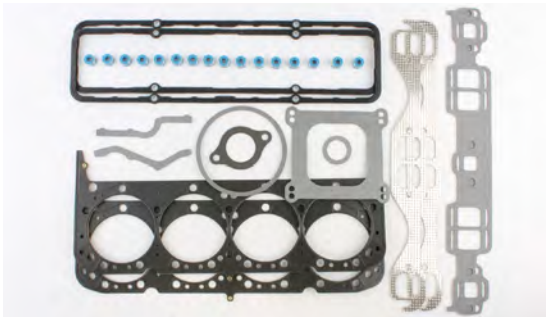

Application	Part #	List Price
350ci (67-85) & 400ci (70-76) 4.165" Bore...	PRO1003T	\$232.77
350ci TPI (87-92), TBI (86-93) 4.100" Bore..	PRO1004T	\$243.07
ZZ4 Crate Engine 4.080" Bore	PRO1026T	\$216.29

BOTTOM END GASKET KIT

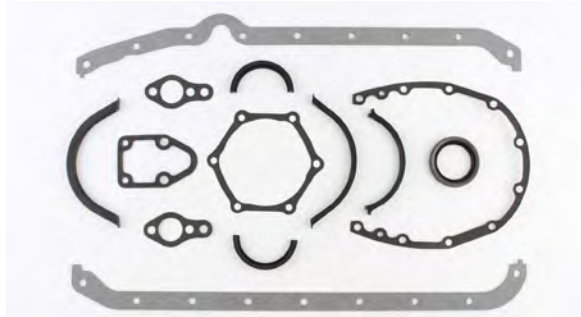

Application	Part #	List Price
350ci (67-79) & 400ci (70-76).....	PRO1003B	\$73.12
350ci (86-93) 1pc Rear Main.....	PRO1004B	\$66.12



Cometic Gasket - An Exclusive NASCAR Performance Product

CHEVROLET / GM

Small Block V8 - Aftermarket & Race

Head Gaskets

MLS Head Gaskets - Vortec Head

Bore	Thickness	Pkg Qty	Part #	List Price
4.080"	.040"	1	C5474-040	\$89.49
4.165"	.040"	1	C5410-040	\$89.49

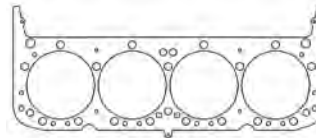

Additional thicknesses available see page 4

MLS Head Gasket - Edelbrock RPM Heads

Bore	Thickness	Pkg Qty	Part #	List Price
4.135"	.040"	1	C5274-040	\$89.49

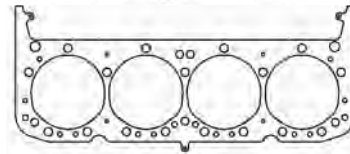

MLS Head Gaskets - Brodix BD2000

Bore	Thickness	Pkg Qty	Part #	List Price
4.030"	.040"	1	C5404-040	\$86.98
4.125"	.040"	1	C5405-040	\$86.98
4.135"	.040"	1	C5406-040	\$86.98
4.160"	.040"	1	C5407-040	\$86.98
4.200"	.040"	1	C5408-040	\$86.98

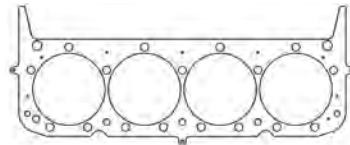

Additional thicknesses available see page 4

MLS Head Gaskets - Brodix Heads

Bore	Thickness	Pkg Qty	Part #	List Price
4.030"	.040"	1	C5399-040	\$86.98
4.125"	.040"	1	C5400-040	\$86.98
4.135"	.040"	1	C5401-040	\$86.98
4.160"	.040"	1	C5402-040	\$86.98
4.200"	.040"	1	C5403-040	\$86.98

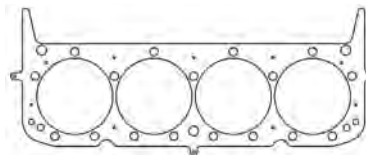

Head Gaskets

MLX Head Gasket - All Pro Heads

Bore	Thickness	Pkg Qty	Part #	List Price
4.220"	.040"	1	C5551-040	\$115.07

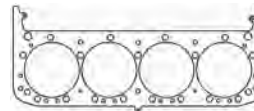

Additional thicknesses available see page 4

NEW!

MLS Head Gasket - Dart/Brodix 4.5" Bore Spacing

Bore	Thickness	Pkg Qty	Part #	List Price
4.270"	.040"	1	C5215-040	\$92.12

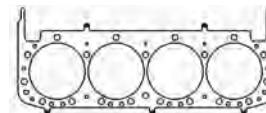

MLX Head Gasket - Dart/Brodix 4.5" Bore Spacing

Bore	Thickness	Pkg Qty	Part #	List Price
4.310"	.040"	1	C15208-040	\$115.07

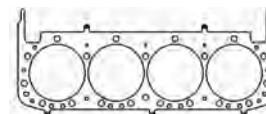

Individual Gaskets

Intake Manifold Gaskets

Application	Part #	List Price
23° Dart Cast Iron	C5528-060	\$29.41
Brodix BD2000	C5421-060	\$25.95
Brodix WP 12S	C5425-059	\$25.95
Brodix WP 247	C5426-059	\$25.95
Brodix WP 262	C5427-059	\$25.95
Brodix GB 2000	C5423-059	\$25.95
Brodix Track 1 & Spec Head	C5414-059	\$25.95
Brodix Street	C5416-059	\$25.95
China Rail Gaskets	C5536-060	\$6.17

Exhaust Manifold Gaskets

Application	Part #	List Price
Brodix GB 2000 - .064" AM	C5422-064	\$21.89
Brodix Track 1 - .064" AM	C5415-064	\$21.89
Brodix Street - .064" AM	C5417-064	\$21.89
Brodix/All Pro 286 (7 Bolt) MLS	C5040-030	\$38.07
Brodix/Dart 13° 4.4/4.5" Spacing	C5039-030	\$38.07

Oil Pan Gasket

Application	Part #	List Price
Dart Iron Eagle/Rocket Block	C5104-094	\$39.36



Cometic Gasket - An Exclusive NASCAR Performance Product

CHEVROLET / GM

350 & 400 SB2 Race V8

Head Gaskets

MLS Head Gaskets

Bore	Thickness	Pkg Qty	Part #	List Price
4.125"	.040"	1	C5321-040	\$89.49
4.165"	.040"	1	C5323-040	\$89.49
4.190"	.040"	1	C5472-040	\$89.49
4.200"	.040"	1	C5324-040	\$89.49

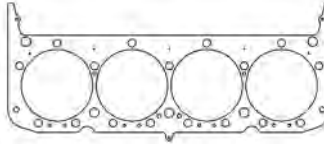

Additional thicknesses available
see page 4

Individual Gaskets

Valve Cover Gasket (sold individually)

Application	Part #	List Price
SB2 - .188" Thickness	C5235-188	\$20.86

Timing Cover Gasket

Application	Part #	List Price
SB2 - .020" RC	C5533-020	\$20.86

Intake Manifold Set

Application	Part #	List Price
SB2 - 2.085" x 1.560" Ports	C5311-031	\$33.15
SB2 - MLS	C5819-040	\$73.58

Water Pump Gasket

Application	Part #	List Price
Water Pump MTG Gasket	C5299-018	\$0.70
Water Pump Backing Plate Gasket	C15011-032	\$6.05

Intake Valley Plate Gaskets

Application	Part #	List Price
Stock Opening - .060" AFM	C5647-060	\$23.69
.970" Holes - .060" AFM	C5308-060	\$23.69
.625"/.750" Holes - .060" AFM	C5307-060	\$23.69

Exhaust Manifold Gaskets

Application	Part #	List Price
1.50" x 1.60" Ports - MLS	C5552-065	\$35.05
1.90" x 1.63" Ports - MLS	C5836-030	\$55.59

Rear Main Seal

Application	Part #	List Price
Dual Lip/High Vacuum	C5379	\$58.66

Oil Pan Gasket

Application	Part #	List Price
SB2 - 4pc Set	C5553-060	\$36.82

Distributor Gasket

Application	Part #	List Price
.060" Fiber	C5531-060	\$1.30

Fuel Pump Mounting Gasket

Application	Part #	List Price
4 Bolt - .032" AFM	C15012-032	\$1.79

R07.2 Race V8

Head Gasket

MLX Head Gasket

Bore	Thickness	Pkg Qty	Part #	List Price
4.220"	.040"	1	C5577-040	\$115.84

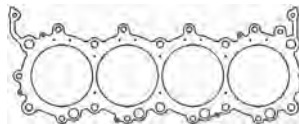

Additional thicknesses available
see page 4

Individual Gaskets

Rubber Seal/O-Ring Kit

Application	Part #	List Price
R07.2	C5979	\$236.11

Valve Cover Gasket (sold individually)

Application	Part #	List Price
Nitrile Formed Rubber O-Ring	C15013	\$18.90



Cometic Gasket - An Exclusive NASCAR Performance Product

CHEVROLET / GM

LT1/LT4 350ci 1992-1996

Head Gaskets

MLS Head Gaskets

Bore	Thickness	Pkg Qty	Part #	List Price
4.040"	.040"	1	C5645-040	\$89.49
4.100"	.040"	1	C5646-040	\$89.49

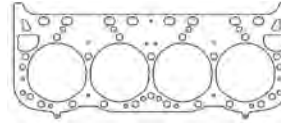

Additional thicknesses available
see page 4

Individual Gaskets

Valve Cover Gasket (sold individually)

Application	Part #	List Price
.094" Thickness	C15014-094	\$112.33

Exhaust Manifold Gaskets

Application	Part #	List Price
1.52" x 1.51" Ports, MLS	C5895-030	\$43.21

Intake Manifold Set

Application	Part #	List Price
LT1/LT4 - 2.085" x 1.560" Ports	C15015-060	\$34.26

Throttle Body Gasket Gasket

Application	Part #	List Price
1992-97 LT1/LT4	C15016-060	\$5.73

Oil Pan Gasket Set

Application	Part #	List Price
1992-97 1 pc Molded Rubber	C5072	\$37.09

Rear Main Seal Kit

Application	Part #	List Price
1 Piece Viton	C5106	\$26.99

Exhaust Pipe Gaskets

Application	Part #	List Price
Header Collector Gasket	C15017-064	\$4.49
Y-Pipe Gasket	C15018-064	\$6.76

Timing Cover Sets

Application	Part #	List Price
1992-94	C5054	\$16.98
1994-97	C5055	\$22.65

Water Pump Gasket

Application	Part #	List Price
Water Pump Mounting Gasket	C15019-031	\$5.51

LS1/LS6 5.7L, LS2 6.0L, & LS3 6.2L

Head Gaskets

MLS Head Gaskets

Bore	Thickness	Pkg Qty	Part #	List Price
3.810"	.051"	1	C15361-051	\$89.49
3.910"	.051"	1	C5475-051	\$89.49
4.060"	.051"	1	C5751-051	\$89.49
4.100"	.051"	1	C5489-051	\$89.49
4.130"	.051"	1	C5317-051	\$89.49
4.160"	.051"	1	C5318-051	\$89.49
4.190"	.051"	1	C5319-051	\$89.49

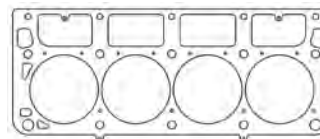

Additional thicknesses available
see page 4

NEW!

MLX Head Gaskets

Bore	Thickness	Pkg Qty	Part #	List Price
4.040"	.051"	1	C5505-051	\$115.07
4.150"	.040"	1	C5014-040	\$115.07
4.150"	.052"	1	C5514-052	\$115.07

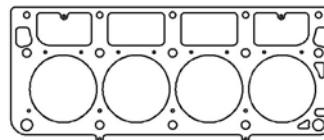

NEW!

Copper Head Gaskets

Bore	Thickness	Pkg Qty	Part #	List Price
4.100"	.050"	1	C15408-050	\$112.13

Individual Gaskets

Valve Cover Gasket (sold individually)

Application	Part #	List Price
99-14 LS V8 - Center Bolt	C5170	\$13.46
Valve Cover Grommet Set	C15030	\$10.90

Exhaust Manifold Gaskets

Application	Part #	List Price
97-13 LS V8 - Round Port	C5818-030	\$36.17

See page 16 for additional gaskets



Cometic Gasket - An Exclusive NASCAR Performance Product

CHEVROLET / GM

LS1/LS6 5.7L, LS2 6.0L, & LS3 6.2L

Individual Gaskets

Intake Manifold Gaskets

Application	Part #	List Price
99-05 5.7/6.0L Car Intake.....	C5165	\$37.30
99-05 5.3/6.0L Truck Intake.....	C5166	\$66.72
LS3/L92 Carb Intake Gaskets.....	C15022-060	\$26.35
08-13 LS3 6.2L Car Intake.....	C5037	\$36.41
07-13 6.0/6.2L Truck Intake.....	C15024	\$71.59
Gen III LS1/LS6 Valley Gasket.....	C15026	\$22.14
Gen IV LS w/D.O.D. Valley Gasket.....	C15023	\$61.33
Gen IV LS w/o D.O.D. Valley Gasket.....	C15025	\$30.44

Throttle Body Gaskets

Application	Part #	List Price
97-05 4.8/5.3/5.7L.....	C5168	\$11.97
99-05 6.0L.....	C5169	\$11.97
2005 5.3/6.0L SUV.....	C15020	\$8.38
06-13 4.8/5.3/6.0/6.2L.....	C15021	\$13.65

Rear Main Seal Kit

Application	Part #	List Price
1997-13 LS V8.....	C5172	\$56.70

Fuel Injector O-Ring Set

Application	Part #	List Price
Upper and Lower O-Rings.....	C15027	\$24.40

Oil Pan Gasket Set

Application	Part #	List Price
97-13 LS V8 (not Vette).....	C5173	\$50.83

Exhaust Pipe Gaskets

Application	Part #	List Price
Graphite Exhaust Pipe.....	C15028	\$8.69
Metal Ring Exhaust Pipe.....	C15029	\$7.48

Valve Stem Seals

Application	Part #	List Price
97-01 LS V8.....	3516PB-16	\$23.84
02-13 LS V8 - Hat Style.....	3256V-16	\$21.89

Cooling/Water Pump Gaskets

Application	Part #	List Price
99-13 LS V8 (pair) Molded.....	C5174	\$9.60
99-13 LS V8 (pair) .031" Fiber.....	C15032-031	\$5.20
99-13 Water Pump Backing O-ring.....	C15033	\$1.72
97-13 Coolant Bypass Seals.....	C15034	\$5.55

Timing Cover Set

Application	Part #	List Price
1997-13 LS V8.....	C5056	\$38.49

Knock Sensor Grommet Kit

Application	Part #	List Price
1999-2013 - 2 Pack.....	C15035	\$6.38

Cam Plate Gasket

Application	Part #	List Price
with Recessed Bolts.....	C15031	\$26.23

Thermostat Seal

Application	Part #	List Price
2004-13 Gen IV.....	C15036	\$6.11

Gasket Kits



To purchase a complete gasket kit order both top end and bottom end gasket kit

TOP END GASKET KIT



BOTTOM END GASKET KIT

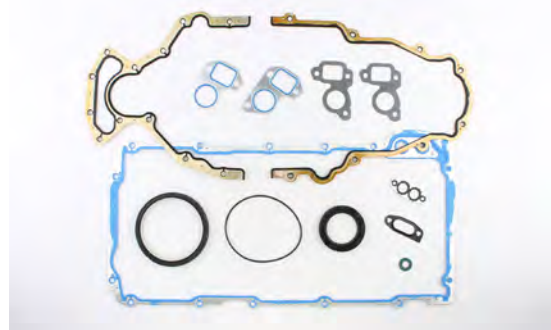

Application	Part #	List Price
1997-05 LS1 5.7L (Car Only) 4.100" Bore.....	PRO1007T	\$232.77
LS3/L92 6.2L Carbureted 4.060" Bore.....	PRO1035T	\$182.94
1999-01 6.0L (Truck Only) 4.100" Bore.....	PRO1008T	\$205.99
2001-10 4.8/5.3L Truck/Van/SUV 3.840" Bore.....	PRO1040T	\$346.07
2001-07 6.0L Truck/Van/SUV 4.060" Bore.....	PRO1041T	\$253.37
2005-07 6.0L Truck/Van/SUV 4.100" Bore.....	PRO1037T	\$294.57
2007-10 6.0/6.2L Truck/Van/SUV 4.100" Bore.....	PRO1036T	\$329.59
2009-11 LS3 6.2L (Car Only).....	PRO1043T	\$284.27

Application	Part #	List Price
4.8/5.3/5.7/6.0/6.2L LS V8.....	PRO1040B	\$160.90
with flat mount Cam Plate bolts		
4.8/5.3/5.7/6.0/6.2L LS V8.....	PRO1036B	\$209.90
with recessed Cam Plate bolts		



Cometic Gasket - An Exclusive NASCAR Performance Product

CHEVROLET / GM

LS7 7.0L V8

Head Gaskets

MLS Head Gasket				
Bore	Thickness	Pkg Qty	Part #	List Price
4.150"	.051"	1	C5889-051	\$98.23

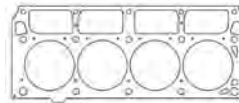

Additional thicknesses available see page 4

MLX Head Gasket				
Bore	Thickness	Pkg Qty	Part #	List Price
4.150"	.052"	1	C5030-052	\$115.07

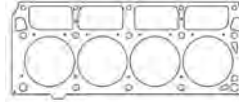

Individual Gaskets

Valve Cover Gasket (sold individually)		
Application	Part #	List Price
99-13 LS V8 - Center Bolt	C5170	\$13.46
Valve Cover Grommet Set	C15030	\$10.90

Intake Manifold Gaskets		
Application	Part #	List Price
LS7 2006-13 w/Carb Intake	C5167-060	\$27.14
Gen IV LS w/o D.O.D. Valley Gasket	C15025	\$31.35

Exhaust Manifold Gaskets		
Application	Part #	List Price
2006-13 D-Port - MLS	C5073-030	\$36.17

Valve Stem Seals		
Application	Part #	List Price
05-13 LS7 V8 - Hat Style	3256V-16	\$24.34

Fuel Injector O-Ring Set		
Application	Part #	List Price
Upper and Lower O-Rings	C15027	\$25.13

Timing Cover Set		
Application	Part #	List Price
1997-13 LS V8	C5056	\$39.64

Cooling/Water Pump Gaskets		
Application	Part #	List Price
99-13 LS V8 (pair) Molded	C5174	\$9.89
99-13 LS V8 (pair) .031" Fiber	C15032-031	\$5.36
99-13 Water Pump Backing O-ring	C15033	\$1.77
97-13 Coolant Bypass Seals	C15034	\$5.72

Rear Main Seal Kit		
Application	Part #	List Price
1997-13 LS V8	C5172	\$58.60

LS9/LSA 6.2L 2009-2013

Head Gaskets

MLX Head Gasket - Right Side				
Bore	Thickness	Pkg Qty	Part #	List Price
4.100"	.051"	1	C5985-051	\$115.07

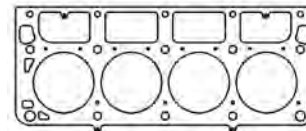

Additional thicknesses available see page 4

MLX Head Gasket - Left Side				
Bore	Thickness	Pkg Qty	Part #	List Price
4.100"	.051"	1	C5986-051	\$115.07

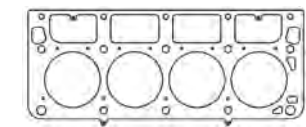

Individual Gaskets

Valve Cover Gasket (sold individually)		
Application	Part #	List Price
99-13 LS V8 - Center Bolt	C5170	\$13.46
Valve Cover Grommet Set	C15030	\$10.90

Valve Stem Seals		
Application	Part #	List Price
09-13 LS V8 - Hat Style	3256V-16	\$24.34

Exhaust Manifold Gaskets		
Application	Part #	List Price
09-13 LS V8 - Round Port	C5818-030	\$36.17

Oil Pan Gasket Set		
Application	Part #	List Price
97-13 LS V8 (Pan to Block)	C5173	\$52.35

Intake Manifold Gaskets		
Application	Part #	List Price
Gen IV LS w/o D.O.D. Valley Gasket	C15025	\$31.35

Timing Cover Set		
Application	Part #	List Price
1997-13 LS V8	C5056	\$39.64



Cometic Gasket - An Exclusive NASCAR Performance Product

CHEVROLET / GM

LS9/LSA 6.2L 2009-2013

Individual Gaskets

Cooling/Water Pump Gaskets

Application	Part #	List Price
99-13 LS V8 (pair) Molded	C5174	\$9.89
99-13 LS V8 (pair) .031" Fiber.....	C15032-031	\$5.36
99-13 Water Pump Backing O-ring.....	C15033	\$1.77
97-13 Coolant Bypass Seals	C15034	\$5.72

Rear Main Seal Kit

Application	Part #	List Price
1997-13 LS V8.....	C5172	\$58.40

GM/DART LS NEXT BLOCK

Head Gaskets

NEW!

MLX Head Gasket - Right Side

Bore	Thickness	Pkg Qty	Part #	List Price
4.200"	.052"	1	C15362-052	\$115.07

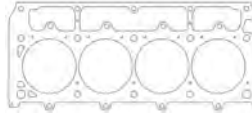

Additional thicknesses available
see page 4

NEW!

MLX Head Gasket - Left Side

Bore	Thickness	Pkg Qty	Part #	List Price
4.200"	.052"	1	C15363-052	\$115.07

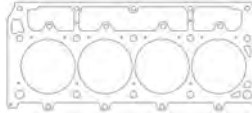

1/2" & 3/8" Stud Hole Combination

LSX RACE BLOCK

Head Gaskets

MLS Head Gaskets - Right Side

Bore	Thickness	Pkg Qty	Part #	List Price
4.125"	.051"	1	C5933-051	\$89.49
4.125"	.140"	1	C5933-140	\$228.43
4.185"	.051"	1	C5935-051	\$89.49

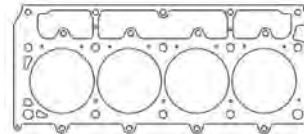

Additional thicknesses available
see page 4

MLS Head Gaskets - Left Side

Bore	Thickness	Pkg Qty	Part #	List Price
4.125"	.051"	1	C5934-051	\$89.49
4.185"	.051"	1	C5936-051	\$89.49

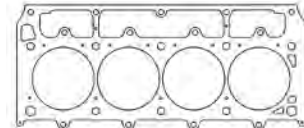

MLX Head Gaskets - Right Side

Bore	Thickness	Pkg Qty	Part #	List Price
4.100"	.040"	1	C5075-040	\$115.07
4.150"	.040"	1	C5702-040	\$115.07
4.200"	.040"	1	C5077-040	\$115.07

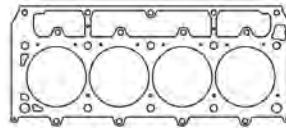

MLX Head Gaskets - Left Side

Bore	Thickness	Pkg Qty	Part #	List Price
4.100"	.040"	1	C5076-040	\$115.07
4.150"	.040"	1	C5703-040	\$115.07
4.200"	.040"	1	C5078-040	\$115.07

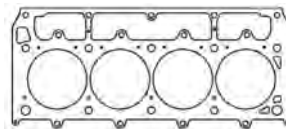

NEW!

Copper Head Gaskets - Left Side

Bore	Thickness	Pkg Qty	Part #	List Price
4.100"	.043"	1	C15409-043	\$112.13

NEW!

Copper Head Gaskets - Right Side

Bore	Thickness	Pkg Qty	Part #	List Price
4.100"	.043"	1	C15410-043	\$112.13



Cometic Gasket - An Exclusive NASCAR Performance Product

CHEVROLET / GM

LSX RACE BLOCK

Individual Gaskets

Oil Pan Gasket Set		
Application	Part #	List Price
97-13 LS V8 (Pan to Block)	C5173	\$52.35

Timing Cover Set		
Application	Part #	List Price
1997-13 LS V8	C5056	\$39.64

Valve Cover Gasket (sold individually)		
Application	Part #	List Price
99-13 LS V8 - Center Bolt	C5170	\$13.46
Valve Cover Grommet Set	C15030	\$10.90

Intake Manifold Gaskets		
Application	Part #	List Price
LS7 2006-13 w/Carb Intake	C5167-060	\$27.14
LSX-DR Head - Lrg Port	C15037-060	\$29.53
Gen IV LS w/o D.O.D. Valley Gasket	C15025	\$31.35

Cooling/Water Pump Gaskets		
Application	Part #	List Price
99-13 LS V8 (pair) Molded	C5174	\$9.89
99-13 LS V8 (pair) .031" Fiber	C15032-031	\$5.36
99-13 Water Pump Backing O-ring	C15033	\$1.77
97-13 Coolant Bypass Seals	C15034	\$5.72

Exhaust Manifold Gaskets		
Application	Part #	List Price
2006-13 D-Port - MLS	C5073-030	\$36.17
LSX-DR .064" AM	C15038-064	\$31.68

Valve Stem Seals		
Application	Part #	List Price
09-13 LS V8 - Hat Style	3256V-16	\$24.34

Gasket Kits



To purchase a complete gasket kit order both top end and bottom end gasket kit

TOP END GASKET KIT

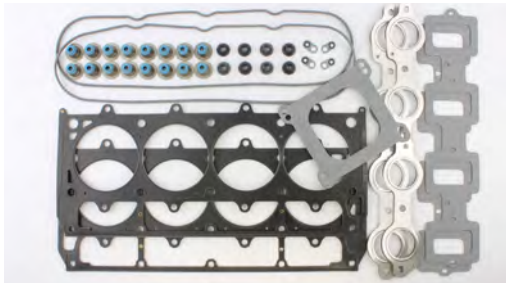

Application	Part #	List Price
LSX w/LS7 Carb Intake 4.125" Bore	PRO1025T	\$175.09

BOTTOM END GASKET KIT

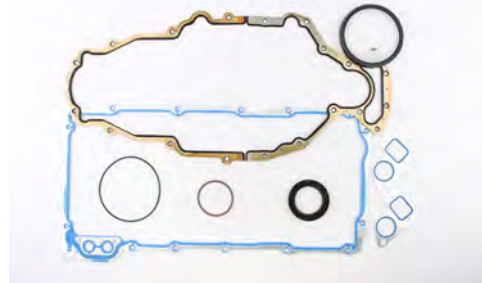

Application	Part #	List Price
LSX V8	PRO1025B	\$137.75

LS1/LS6 5.7L, LS2 6.0L, & LS3 6.2L w/Darton M.I.D. Sleeves

Head Gaskets

MLS Head Gasket				
Bore	Thickness	Pkg Qty	Part #	List Price
3.910"	.040"	1	C5788-040	\$98.23
4.125"	.040"	1	C5789-040	\$98.23
4.165"	.040"	1	C5790-040	\$98.23

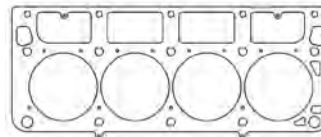

Additional thicknesses available see page 4

LT1/LT4 6.2L V8 2014+UP

Head Gasket

MLX Head Gasket				
Bore	Thickness	Pkg Qty	Part #	List Price
4.100"	.051"	1	C5038-051	\$115.07
4.150"	.051"	1	C15203-051	\$115.07
4.200"	.051"	1	C15202-051	\$115.07

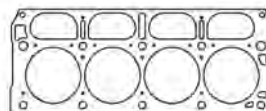

Additional thicknesses available see page 4

See page 20 for additional gaskets



Cometic Gasket - An Exclusive NASCAR Performance Product

CHEVROLET / GM

LT1/LT4 6.2L V8 2014+UP

Individual Gaskets

Exhaust Manifold Gasket

Application	Part #	List Price
2014+ 1.920" Port - .021" MLS	C5020-021	\$50.10

Holden 308 V8

Head Gaskets

MLS Head Gaskets

Bore	Thickness	Pkg Qty	Part #	List Price
4.100"	.040"	1	C5806-040	\$100.67
4.200"	.040"	1	C5807-040	\$100.67

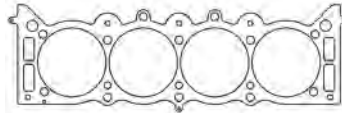

Additional thicknesses available see page 4

348ci 1958-61/409ci 1961-65 "W" V8

Head Gaskets

MLS Head Gaskets

Bore	Thickness	Pkg Qty	Part #	List Price
4.200"	.040"	1	C5255-040	\$98.23
4.375"	.040"	1	C5256-040	\$98.23
4.437"	.040"	1	C5219-040	\$98.23

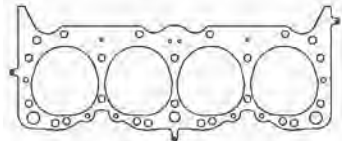

Additional thicknesses available see page 4

Individual Gaskets

Intake Manifold Gasket

Application	Part #	List Price
409ci V8 - .059" CFM	C15039-059	\$33.19

Exhaust Manifold Gasket

Application	Part #	List Price
409ci V8 - .064" AM	C15040-064	\$33.19

Big Block V8 - Gen4 1965-90 396,402,427,454ci

Head Gaskets

MLS Head Gaskets

Bore	Thickness	Pkg Qty	Part #	List Price
4.320"	.040"	1	C5816-040	\$100.67
4.375"	.040"	1	C5329-040	\$100.67
4.540"	.040"	1	C5330-040	\$100.67
4.630"	.040"	1	C5331-040	\$100.67

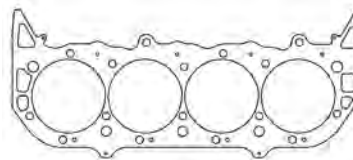

Additional thicknesses available see page 4

NEW!

Copper Head Gaskets

Bore	Thickness	Pkg Qty	Part #	List Price
4.320"	.043"	1	C15413-043	\$127.05
4.530"	.043"	1	C15414-043	\$127.05
4.630"	.043"	1	C15415-043	\$127.05

Individual Gaskets

Valve Cover Gasket (sold individually)

Application	Part #	List Price
Molded Rubber .188"	C5975	\$22.65

Intake Manifold Gaskets

Application	Part #	List Price
Rect Port 1.75" x 2.50" - .060" KF	C5649-060	\$29.41
Oval Port 1.82" x 2.05" - .060" KF	C15041-060	\$29.41

Exhaust Manifold Gaskets

Application	Part #	List Price
1.85" x 1.90" Sq Port - MLS	C5897-030	\$44.28
1.920" Round Port - MLS	C5896-030	\$44.28
2.000" Round Port - MLS	C5349-030	\$44.28
2.130" Round Port - MLS	C5996-030	\$44.28
2.200" Round Port - MLS	C5350-030	\$44.28
2.250" Round Port - MLS	C5251-030	\$44.28



Cometic Gasket - An Exclusive NASCAR Performance Product

CHEVROLET / GM

Big Block V8 - Gen4 1965-90 396,402,427,454ci

Individual Gaskets

Rear Main Seal Kit		
Application	Part #	List Price
2pc 1965-90 - Silicone.....	C5086	\$18.90
2pc 1965-90 - Viton.....	C5682	\$28.55

Cooling/Water Pump Gaskets		
Application	Part #	List Price
Water Pump Mounting - Req 2.....	C5347-039	\$5.30
Water Outlet.....	C5346-047	\$1.13

Timing Cover Sets		
Application	Part #	List Price
1965-95 BBC V8.....	C5057	\$22.65

Oil Pan Gasket Set		
Application	Part #	List Price
4pc Kit.....	C5344	\$33.15

Gasket Kits

To purchase a complete gasket kit order both top end and bottom end gasket kit

TOP END GASKET KIT

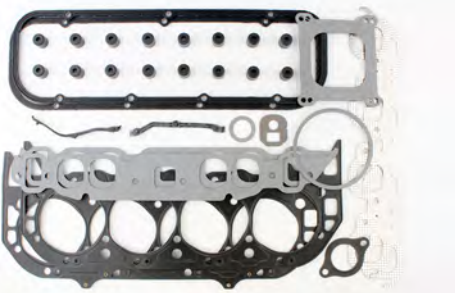

Application	Part #	List Price
454ci 1970-85 4.275" Bore.....	PRO1005T	\$195.69

BOTTOM END GASKET KIT



Application	Part #	List Price
Big Block Gen4.....	PRO1005B	\$50.69

Big Block V8 - Gen5/6 1991-00 454, 502ci

Head Gaskets

MLS Head Gaskets				
Bore	Thickness	Pkg Qty	Part #	List Price
4.320"	.040"	1.....	C5817-040	\$100.67
4.375"	.040"	1.....	C5332-040	\$100.67
4.540"	.040"	1.....	C5333-040	\$100.67
4.630"	.040"	1.....	C5334-040	\$100.67

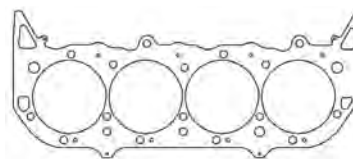

Additional thicknesses available see page 4

Individual Gaskets

Valve Cover Gasket (sold individually)		
Application	Part #	List Price
Molded Rubber .188".....	C5975	\$22.65

Exhaust Manifold Gaskets		
Application	Part #	List Price
1.85" x 1.90" Sq Port - MLS.....	C5897-030	\$44.28
1.920" Round Port - MLS.....	C5896-030	\$44.28
2.000" Round Port - MLS.....	C5349-030	\$44.28
2.130" Round Port - MLS.....	C5996-030	\$44.28
2.200" Round Port - MLS.....	C5350-030	\$44.28
2.250" Round Port - MLS.....	C5251-030	\$44.28

Intake Manifold Gaskets		
Application	Part #	List Price
Rect Port 1.75" x 2.50" - .060" KF.....	C5649-060	\$29.41
Oval Port 1.82" x 2.05" - .060" KF.....	C15041-060	\$29.41

Timing Cover Sets		
Application	Part #	List Price
1990-95 BBC V8.....	C5057	\$22.65
1996-00 BBC V8.....	C5058	\$16.98

Cooling/Water Pump Gaskets		
Application	Part #	List Price
Water Pump Mounting - Req 2.....	C5347-039	\$5.30
Water Outlet.....	C5346-047	\$1.13

Rear Main Seal Kit		
Application	Part #	List Price
2pc 1991-00 Gen 5/6 - Viton.....	C5087	\$29.41

Oil Pan Gasket Set		
Application	Part #	List Price
1pc Molded Rubber.....	C15077	\$28.52



Cometic Gasket - An Exclusive NASCAR Performance Product

CHEVROLET / GM

Big Block V8 - Aftermarket, Race, & Marine Blocks

Head Gaskets

MLS Head Gaskets - Mercury Gen4/5/6 w/4 Bolts in Lifter Valley

Bore	Thickness	Pkg Qty	Part #	List Price
4.500"	.051"	1	C5634-051	\$92.12
4.530"	.051"	1	C5635-051	\$92.12
4.580"	.051"	1	C5636-051	\$92.12
4.600"	.051"	1	C5637-051	\$92.12

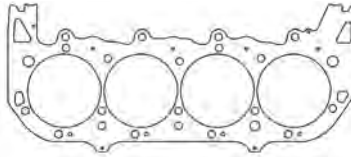

Additional thicknesses available
see page 4

MLS Head Gaskets - Mercury 1050 Gen 4 w/2 Slotted Lifter Valley Bolts

Bore	Thickness	Pkg Qty	Part #	List Price
4.500"	.051"	1	C5638-051	\$92.12
4.530"	.051"	1	C5639-051	\$92.12
4.580"	.051"	1	C5640-051	\$92.12
4.600"	.051"	1	C5641-051	\$92.12

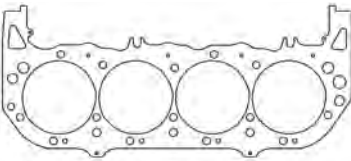

MLS Head Gaskets - Mercury Marine 526/625 Gen

Bore	Thickness	Pkg Qty	Part #	List Price
4.470"	.040"	1	C5760-040	\$100.67

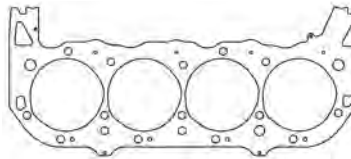

MLS Head Gaskets - Mercury 8.1L 496 - Right Side

Bore	Thickness	Pkg Qty	Part #	List Price
4.280"	.051"	1	C5761-051	\$100.67
4.350"	.051"	1	C5762-051	\$100.67
4.450"	.051"	1	C5763-051	\$100.67

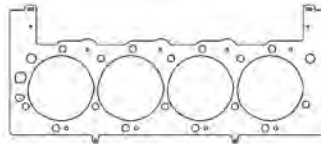

MLS Head Gaskets - Mercury 8.1L 496 - Left Side

Bore	Thickness	Pkg Qty	Part #	List Price
4.280"	.051"	1	C5764-051	\$100.67
4.350"	.051"	1	C5765-051	\$100.67
4.450"	.051"	1	C5766-051	\$100.67

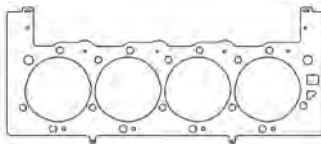

MLS Head Gaskets - Brodix Big Duke/Big Brodie

Bore	Thickness	Pkg Qty	Part #	List Price
4.310"	.040"	1	C5432-040	\$92.12
4.570"	.040"	1	C5433-040	\$92.12
4.630"	.040"	1	C5434-040	\$92.12

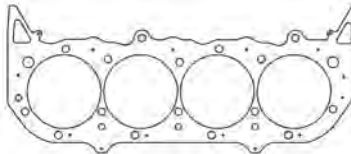

MLS Head Gaskets - ZL1 1969 7.0L 427ci Aluminum Round Bore

Bore	Thickness	Pkg Qty	Part #	List Price
4.250"	.040"	1	C5746-040	\$100.67
4.300"	.040"	1	C5747-040	\$100.67
4.375"	.040"	1	C5759-040	\$100.67

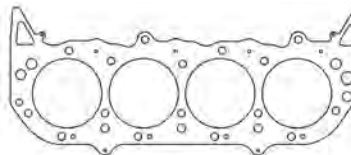



Cometic Gasket - An Exclusive NASCAR Performance Product

CHEVROLET / GM

Big Block V8 - Aftermarket, Race, & Marine Blocks

Individual Gaskets

Valve Cover Gasket (sold individually)		
Application	Part #	List Price
Molded Rubber .188"	C5975	\$22.65

Exhaust Manifold Gaskets		
Application	Part #	List Price
Brodix Big Brodie - .064" AM	C5429-064	\$21.89
Brodix Big Duke - .064" AM	C5418-064	\$21.89
Mercury 525/625 EFI - MLS	C15364-030	\$46.51
Mercury 1050 - MLS	C5820-051	\$70.07

Timing Cover Sets		
Application	Part #	List Price
1965-95 BBC V8	C5057	\$22.65
1996-00 BBC V8	C5058	\$16.98

Cooling/Water Pump Gaskets		
Application	Part #	List Price
Water Pump Mounting - Req 2	C5347-039	\$5.30
Water Outlet	C5346-047	\$1.13

Intake Manifold Gaskets		
Application	Part #	List Price
Brodix Big Brodie Oval - .060" KF	C5430-060	\$25.95
Brodix Big Brodie Rectangle-.060" KF	C5428-060	\$25.95
Brodix Big Duke - .060" KF	C5419-060	\$25.95
Mercury 1050 - MLS	C5821-051	\$73.58

Rear Main Seal Kits		
Application	Part #	List Price
2pc 1965-90 - Silicone	C5086	\$18.90
2pc 1965-90 - Viton	C5682	\$29.41
1pc 1991-00 Gen 5/6 - Viton	C5087	\$29.41

Oil Pan Gasket Set		
Application	Part #	List Price
4pc Kit 1965-90	C5344	\$33.15
4pc Kit Bolt Holes@Mains	C5254	\$33.15
1pc Molded Rubber 91-00	C15077	\$28.52

Prostock Racing V8

Head Gaskets

MLS Head Gaskets - DRCE-2 4.900" Bore Centers 500ci				
Bore	Thickness	Pkg Qty	Part #	List Price
4.675"	.051"	1	C5449-051	\$130.14
4.700"	.051"	1	C5450-051	\$130.14
4.780"	.051"	1	C5451-051	\$130.14

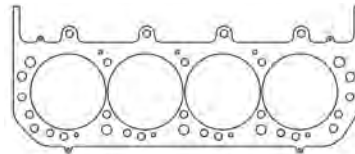

Additional thicknesses available see page 4

MLS Head Gaskets - DRCE-3 4.900" Bore Centers 500ci				
Bore	Thickness	Pkg Qty	Part #	List Price
4.675"	.051"	1	C5796-051	\$130.14
4.700"	.051"	1	C5797-051	\$130.14
4.780"	.051"	1	C5798-051	\$130.14

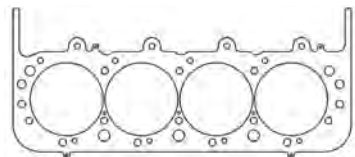

MLS Head Gasket - IHRA 5.00" Bore Centers 800ci				
Bore	Thickness	Pkg Qty	Part #	List Price
4.755"	.040"	1	C5850-040	\$130.14

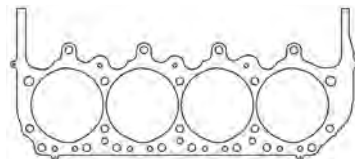

MLX Head Gasket - 5.20" Bore Centers				
Bore	Thickness	Pkg Qty	Part #	List Price
4.860"	.040"	1	C5013-040	\$115.84

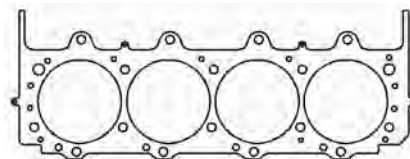

NEW!

MLS Head Gaskets - BRODIX 5.0 Bore Space Big Block V8				
Bore	Thickness	Pkg Qty	Part #	List Price
4.700"	.041"	1	C15397-041	\$130.14
4.760"	.041"	1	C15398-041	\$130.14
4.795"	.041"	1	C15399-041	\$130.14

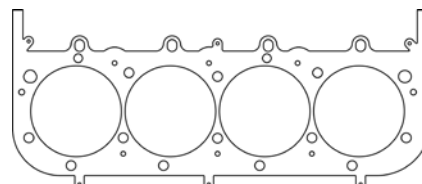



Cometic Gasket - An Exclusive NASCAR Performance Product

CHEVROLET / GM

6.5L Diesel V8 1992-00

Head Gaskets

MLS Head Gaskets - Right Side

Bore	Thickness	Pkg Qty	Part #	List Price
4.100"	.045"	1	C5885-045	\$102.13

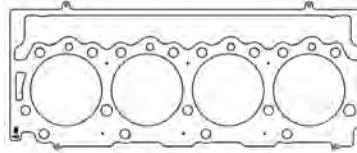

Additional thicknesses available
see page 4

MLS Head Gaskets - Left Side

Bore	Thickness	Pkg Qty	Part #	List Price
4.100"	.045"	1	C5884-045	\$102.13

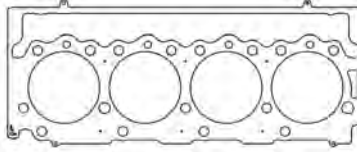

Head Bolt Kit

Bore	Part #	List Price
ARP 190,000 psi	COM-0001	\$280.68

6.6L Duramax Diesel V8 2001-07

Head Gaskets

NEW!

MLX Head Gaskets - Right Side

Bore	Thickness	Pkg Qty	Part #	List Price
4.130"	.053"	1	C15375-053	\$198.70
4.130"	.062"	1	C15375-062	\$198.70

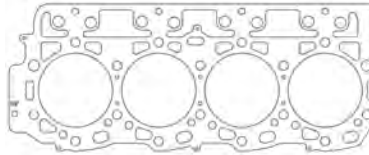

Additional thicknesses available
see page 4

NEW!

MLX Head Gaskets - Left Side

Bore	Thickness	Pkg Qty	Part #	List Price
4.130"	.053"	1	C15376-053	\$198.70
4.130"	.062"	1	C15376-062	\$198.70

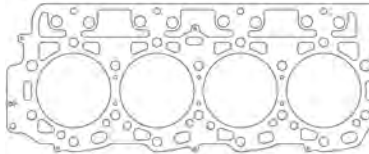

MLS Head Gaskets - Right Side

Bore	Thickness	Pkg Qty	Part #	List Price
4.100"	.040"	1	C5882-040	\$149.87

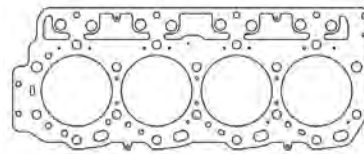

MLS Head Gaskets - Left Side

Bore	Thickness	Pkg Qty	Part #	List Price
4.100"	.040"	1	C5883-040	\$149.87

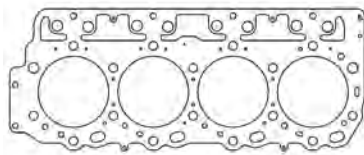

Individual Gaskets

Exhaust Manifold Gaskets

Application	Part #	List Price
2001-04 8mm Bolts - MLS	C15042-030	\$50.10

Rear Main Seal Kit

Application	Part #	List Price
2001-07	C15044	\$61.16

Timing Cover Set

Application	Part #	List Price
2001-07	C15045	\$42.67

Oil Pan Gasket Set

Application	Part #	List Price
2001-06 17 Bolt - .060" KF	C15043	\$18.44



Cometic Gasket - An Exclusive NASCAR Performance Product

CHEVROLET / GM

6.6L Duramax Diesel V8 2001-07

Gasket Kits

To purchase a complete gasket kit order both top end and bottom end gasket kit

TOP END GASKET KITS



Application	Part #	List Price
6.6L Duramax 2001-04 4.100" Bore	PRO3008T	\$466.99
6.6L Duramax 2004-07 4.100" Bore	PRO3009T	\$574.11

BOTTOM END GASKET KIT

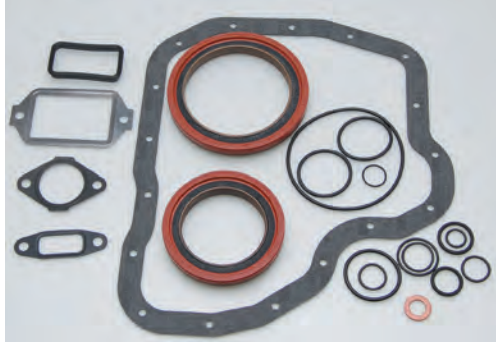

Application	Part #	List Price
6.6L Duramax 2001-07	PRO3008B	\$177.77

CHRYSLER / DODGE

2.0L DOHC 4cyl ECC/420A 1995-99

Head Gaskets

MLS Head Gaskets				
Bore	Thickness	Pkg Qty	Part #	List Price
87.5mm	.040"	1	C5497-040	\$89.49
88.5mm	.040"	1	C5498-040	\$89.49

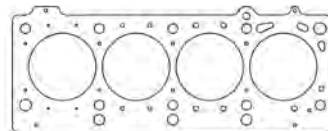

Additional thicknesses available see page 4

Individual Gaskets

Valve Cover Gasket Set		
Application	Part #	List Price
1995-99 2.0L DOHC	C15046	\$2.65

Cam Seal Set		
Application	Part #	List Price
Pair - 48 x 35 x 7	C15049	\$13.42

Intake Manifold Gaskets		
Application	Part #	List Price
Intake Manifold Gasket - .060" AFM	C15047-060	\$11.41
Intake Plenum Gasket - .031" Fiber	C15048-031	\$4.71

Front Crank Seal Set		
Application	Part #	List Price
1995-99 2.0L DOHC	C15053	\$20.59

Exhaust Manifold Gasket		
Application	Part #	List Price
2.040" X 1.100" Port - MLS	C4161-030	\$23.74

Oil Pan Gasket Set		
Application	Part #	List Price
Molded Rubber	C15050	\$28.55

Throttle Body Gasket		
Application	Part #	List Price
Molded Rubber	C15051	\$3.61

Rear Main Seal		
Application	Part #	List Price
1995-99 2.0L DOHC	C15052	\$13.14

Valve Stem Seal Set (16 Pack)		
Application	Part #	List Price
5 x 10.8 x 18.3 x 16.9 - Hat Style	3180V-16	\$32.49

See page 26 for StreetPro gaskets



Cometic Gasket - An Exclusive NASCAR Performance Product

CHRYSLER / DODGE

2.0L DOHC 4cyl ECC/420A 1995-99

Gasket Kits



To purchase a complete gasket kit order both top end and bottom end gasket kit

TOP END GASKET KIT

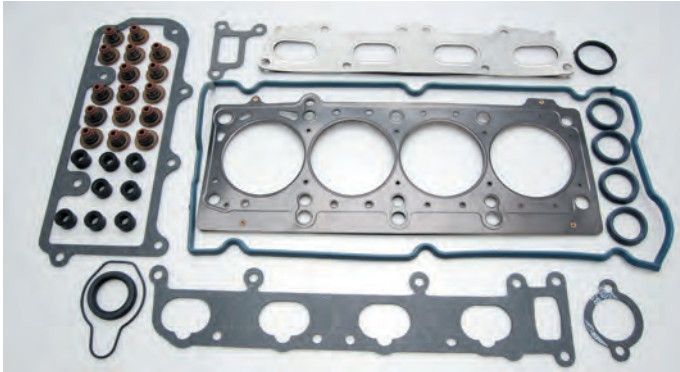

Application	Part #	List Price
1995-99 420A 2.0L DOHC 87.5mm Bore	PRO2005T	\$152.91

BOTTOM END GASKET KIT

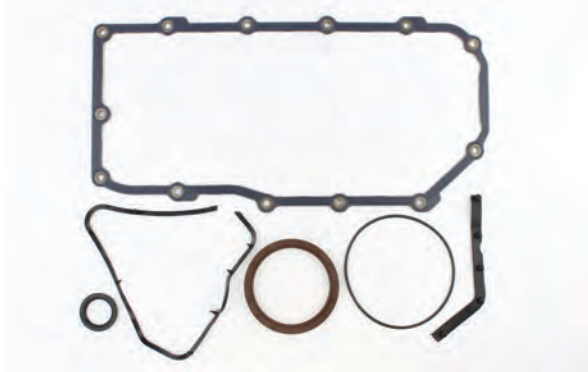

Application	Part #	List Price
1995-99 420A 2.0L DOHC.....	PRO2005B	\$73.15

2.4L DOHC Turbo 4cyl "SRT4" 2003-05

Head Gaskets

MLS Head Gaskets

Bore	Thickness	Pkg Qty	Part #	List Price
87.5mm030"	1	C4548-030	\$98.23
90mm030"	1	C4549-030	\$98.23

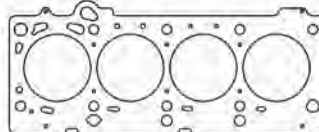

Additional thicknesses available see page 4

2.2L DOHC 4cyl 1991-93

Head Gaskets

MLS Head Gaskets

Bore	Thickness	Pkg Qty	Part #	List Price
89.5mm066"	1	C5733-066	\$136.33

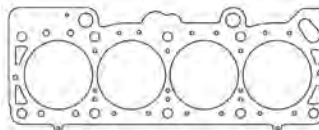

Additional thicknesses available see page 4

2.2L SOHC 4cyl 1982-90, 2.5L SOHC 4cyl 1986-95

Head Gaskets

MLS Head Gaskets

Bore	Thickness	Pkg Qty	Part #	List Price
89.5mm066"	1	C5734-066	\$136.33

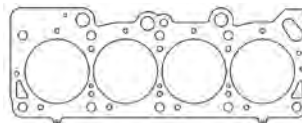

Additional thicknesses available see page 4



Cometic Gasket - An Exclusive NASCAR Performance Product

CHRYSLER / DODGE

3.5L SOHC V6 1999-10, 4.0L SOHC V6 2007-11

Head Gaskets

MLS Head Gasket - Right Side				
Bore	Thickness	Pkg Qty	Part #	List Price
96.5mm	.075"	1	C5015-075	\$79.40

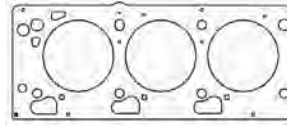

Additional thicknesses available
see page 4

MLS Head Gasket - Left Side				
Bore	Thickness	Pkg Qty	Part #	List Price
96.5mm	.075"	1	C5016-075	\$79.40

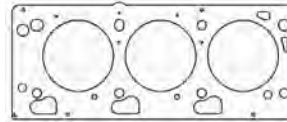

3.7L SOHC V6 2002-13 Powertech "EKG"

Head Gaskets

MLS Head Gasket				
Bore	Thickness	Pkg Qty	Part #	List Price
95mm	.030"	1	C5794-030	\$98.23

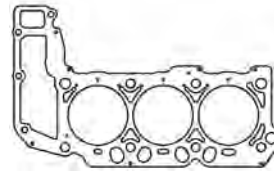

Additional thicknesses available
see page 4

4.0L Inline 6 242ci 1987-2006

87-01 Cherokee, 93-04 Grand Cherokee, 87-90 Wagoneer, 87-92 Comanche, 91-06 Wrangler

Head Gaskets

MLS Head Gaskets				
Bore	Thickness	Pkg Qty	Part #	List Price
3.950	.050"	1	C5987-050	\$119.96
4.000	.050"	1	C5988-050	\$119.96
4.060	.050"	1	C5989-050	\$119.96

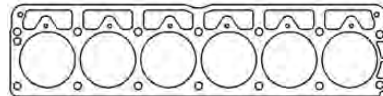

Additional thicknesses available
see page 4

Individual Gaskets

Timing Cover Set			
Application	Part #	List Price	
3.8/4.0/4.2L I6 1965-2006	C5047	\$16.98	

4.7L SOHC V8 1999-13 Powertech

Head Gaskets

MLS Head Gaskets - 1999-07				
Bore	Thickness	Pkg Qty	Part #	List Price
93mm	.030"	1	C5213-030	\$98.23
95mm	.030"	1	C5214-030	\$98.23

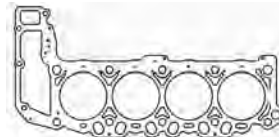

Additional thicknesses available
see page 4

MLS Head Gasket - 2008-13				
Bore	Thickness	Pkg Qty	Part #	List Price
94mm	.030"	1	C5803-030	\$98.23

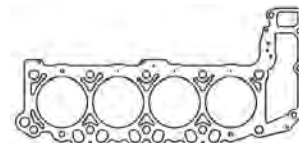



Cometic Gasket - An Exclusive NASCAR Performance Product

CHRYSLER / DODGE

Polyspherical 318 V8 1957-67 (A Engine)

Head Gaskets

NEW!

MLS Head Gaskets

Bore	Thickness	Pkg Qty	Part #	List Price
4.030"	.040"	1	C15296-040	\$103.05

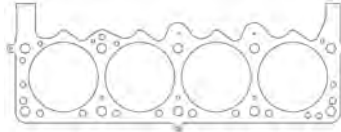

Additional thicknesses available see page 4

5.2L & 5.9L Magnum V8 1992-03

Head Gaskets

MLS Head Gaskets

Bore	Thickness	Pkg Qty	Part #	List Price
4.040"	.040"	1	C5554-040	\$89.49
4.040"	.120"	1	C5565-120	\$228.43

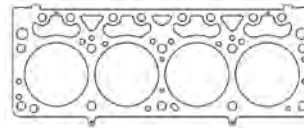

Additional thicknesses available see page 4

Individual Gaskets

Valve Cover Gasket (sold individually)

Application	Part #	List Price
10 Bolt - .047" KF	C5557-047	\$29.41

Oil Pan Gasket Set

Application	Part #	List Price
4pc Set	C5560-094	\$30.65

Intake Manifold Gaskets

Application	Part #	List Price
2.150" x 1.140" Port - .047" KF	C5555-047	\$19.57
China Rail Gaskets	C5556-047	\$7.35

Timing Cover Sets

Application	Part #	List Price
1992-96	C5059	\$22.65
1997-03	C5060	\$22.65

Exhaust Manifold Gasket

Application	Part #	List Price
1.195" x 1.675" - .064" AM	C5558-064	\$24.54

Rear Main Seal

Application	Part #	List Price
2pc Viton	C5564	\$47.90

Cooling/Water Pump Gaskets

Application	Part #	List Price
Water Pump Cover Gasket	C5561-018	\$11.03
Thermostat Gasket	C5562-018	\$1.63

Fuel Pump Gasket

Application	Part #	List Price
Fuel Pump to Block	C5642-031	\$2.27

318/340/360ci V8 "LA" 1964-92

Head Gaskets

MLS Head Gaskets

Bore	Thickness	Pkg Qty	Part #	List Price
4.040"	.040"	1	C5633-040	\$89.49
4.080"	.040"	1	C5622-040	\$89.49
4.125"	.040"	1	C5457-040	\$89.49
4.180"	.040"	1	C5456-040	\$89.49

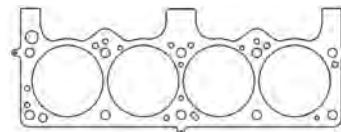

Additional thicknesses available see page 4

MLS Head Gaskets - w/318A Engine Quest or Edelbrock Heads

Bore	Thickness	Pkg Qty	Part #	List Price
4.040"	.040"	1	C5916-040	\$98.23
4.080"	.040"	1	C5917-040	\$98.23
4.125"	.040"	1	C5918-040	\$98.23
4.180"	.040"	1	C5919-040	\$98.23

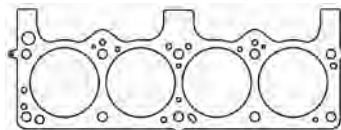

NEW!

Copper Head Gaskets

Bore	Thickness	Pkg Qty	Part #	List Price
4.200"	.043"	1	C15416-043	\$112.13



Cometic Gasket - An Exclusive NASCAR Performance Product

CHRYSLER / DODGE

318/340/360ci V8 "LA" 1964-92

Individual Gaskets

Valve Cover Gasket (sold individually)		
Application	Part #	List Price
5 Bolt - .094" KF.....	C5623-094	\$19.57

Timing Cover Set		
Application	Part #	List Price
1964-91 Set.....	C5061	\$28.31

Intake Manifold Gaskets		
Application	Part #	List Price
1.170" x 2.300" - .060" KF.....	C5624-060	\$29.41
China Rail Gaskets.....	C5625-060	\$7.35

Oil Pan Gasket Sets		
Application	Part #	List Price
4pc 318/340ci V8.....	C5627-094	\$30.65
4pc 360ci V8.....	C5508-094	\$30.65

Exhaust Manifold Gaskets		
Application	Part #	List Price
1.205" x 1.845" - .064" AM.....	C5628-064	\$23.30
1.310" x 1.640" - MLS.....	C5901-030	\$44.28

Rear Main Seal Kit		
Application	Part #	List Price
273/318/340ci 2pc - Viton.....	C5683	\$31.95
360ci 2pc - Viton.....	C5684	\$29.41

Cooling / Water Pump Gaskets		
Application	Part #	List Price
Water Pump Gasket.....	C15054-060	\$11.67
Thermostat Gasket.....	C5574-018	\$1.13

Fuel Pump Gasket		
Application	Part #	List Price
Fuel Pump to Block.....	C5642-031	\$2.27

Gasket Kits



To purchase a complete gasket kit order both top end and bottom end gasket kit

TOP END GASKET KIT

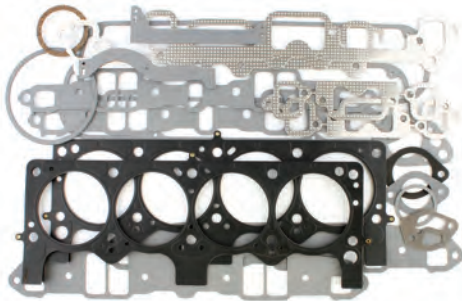

Application	Part #	List Price
1968-89 318, 1968-73 340, 1971-80 360.....	PRO1000T	\$191.57
4.080" Bore		

BOTTOM END GASKET KITS

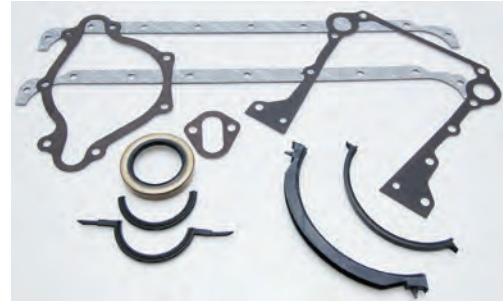

Application	Part #	List Price
360ci V8.....	PRO1000B	\$66.12
318/340ci V8.....	PRO1002B	\$66.12



Cometic Gasket - An Exclusive NASCAR Performance Product

CHRYSLER / DODGE

5.7L Hemi V8 2003-Present

Head Gaskets

MLX Head Gaskets - Right Side

Bore	Thickness	Pkg Qty	Part #	List Price
4.000"	.040"	1	C15315-040	\$120.22

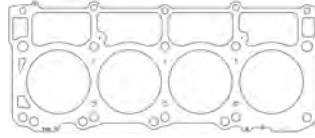

Additional thicknesses available
see page 4

MLX Head Gaskets - Left Side

Bore	Thickness	Pkg Qty	Part #	List Price
4.000"	.040"	1	C15316-040	\$120.22

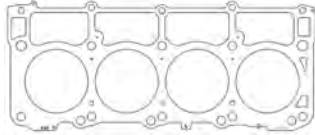

MLS Head Gaskets - Right Side

Bore	Thickness	Pkg Qty	Part #	List Price
3.950"	.027"	1	C5467-027	\$98.23
4.100"	.027"	1	C5749-027	\$98.23

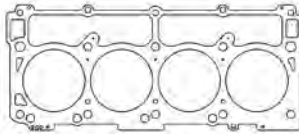

Additional thicknesses available
see page 4

MLS Head Gaskets - Left Side

Bore	Thickness	Pkg Qty	Part #	List Price
3.950"	.027"	1	C5468-027	\$98.23
4.100"	.027"	1	C5750-027	\$98.23

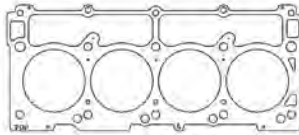

Individual Gaskets

Valve Cover Gasket (sold individually)

Application	Part #	List Price
Molded Rubber (Need 2)	C5193	\$16.98

Thermostat Housing Gasket

Application	Part #	List Price
Molded Rubber	C5198	\$3.35

Intake Manifold Gasket Set

Application	Part #	List Price
Molded Rubber - Set of 8	C5196	\$19.81

Oil Pan Gasket Set

Application	Part #	List Price
Intergrated Windage Tray	C5201	\$67.87

Throttle Body Gasket

Application	Part #	List Price
Molded Rubber	C5199	\$9.99

Timing Cover Set

Application	Part #	List Price
2003-15 5.7L Hemi	C5202	\$39.64

Exhaust Gaskets

Application	Part #	List Price
MLS Exhaust Gaskets - Pair	C5854-030	\$38.55

Rear Main Seal Kit

Application	Part #	List Price
Seal and Housing Gasket	C5203	\$20.14

Valve Stem Seal Set (16 Pack)

Application	Part #	List Price
Hat Style - Viton Steel Body - EXH	3260V-16	\$64.27
Hat Style - Viton Steel Body - INT	3261V-16	\$41.82

Water Pump Gasket

Application	Part #	List Price
Molded Rubber	C5204	\$6.75



Cometic Gasket - An Exclusive NASCAR Performance Product

CHRYSLER / DODGE

5.7L Hemi V8 2003-15

Gasket Kits



To purchase a complete gasket kit order both top end and bottom end gasket kit

TOP END GASKET KIT



Application	Part #	List Price
2003-08 5.7L V8 3.950 Bore	PRO1022T	\$243.07

BOTTOM END GASKET KIT



Application	Part #	List Price
2003-08 5.7L V8	PRO1022B	\$138.85

6.1L Hemi V8 2005-10

Head Gaskets

MLS Head Gaskets				
Bore	Thickness	Pkg Qty	Part #	List Price
4.100"	.040"	1	C5876-040	\$98.23
4.125"	.040"	1	C5441-040	\$98.23
4.185"	.040"	1	C5042-040	\$98.23
4.250"	.040"	1	C5890-040	\$98.23

NEW!

MLX Head Gasket				
Bore	Thickness	Pkg Qty	Part #	List Price
4.100"	.040"	1	C15149-040	\$120.22
4.100"	.044"	1	C15149-044	\$120.22
4.100"	.054"	1	C15149-054	\$120.22
4.100"	.058"	1	C15149-058	\$120.22

NEW!

MLS Head Gaskets - Aluminum Sleeved Block				
Bore	Thickness	Pkg Qty	Part #	List Price
4.055"	.040"	1	C5525-040	\$98.23
4.125"	.070"	1	C5526-070	\$136.33
4.125"	.075"	1	C5526-075	\$136.33
4.125"	.040"	1	C5526-040	\$98.23
4.185"	.040"	1	C5527-040	\$98.23

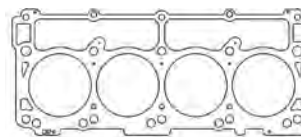
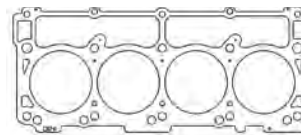
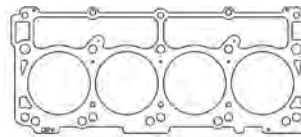

Additional thicknesses available see page 4

Individual Gaskets

Valve Cover Gasket (sold individually)		
Application	Part #	List Price
Molded Rubber (Need 2)	C5193	\$16.98

Thermostat Housing Gasket		
Application	Part #	List Price
Molded Rubber	C5198	\$3.25

Intake Manifold Gasket Set		
Application	Part #	List Price
6.1L - .060" KF	C5197	\$36.17

Oil Pan Gasket Set		
Application	Part #	List Price
Intergrated Windage Tray	C5201	\$85.11

Throttle Body Gasket		
Application	Part #	List Price
Molded Rubber	C5199	\$9.99

Timing Cover Set		
Application	Part #	List Price
2003-15 6.1L Hemi	C5202	\$39.64

See page 32 for additional gaskets



Cometic Gasket - An Exclusive NASCAR Performance Product

CHRYSLER / DODGE

6.1L Hemi V8 2005-10

Individual Gaskets

Exhaust Gaskets

Application	Part #	List Price
MLS Exhaust Gaskets - Pair	C5872-030	\$41.04

Rear Main Seal Kit

Application	Part #	List Price
Seal and Housing Gasket.....	C5203	\$20.14

Valve Stem Seal Set (16 Pack)

Application	Part #	List Price
Hat Style - Viton Steel Body - EXH.....	3260V-16	\$64.27
Hat Style - Viton Steel Body - INT	3261V-16	\$41.82

Water Pump Gasket

Application	Part #	List Price
Molded Rubber	C5204	\$6.75

Gasket Kits



To purchase a complete gasket kit order both top end and bottom end gasket kit

TOP END GASKET KIT

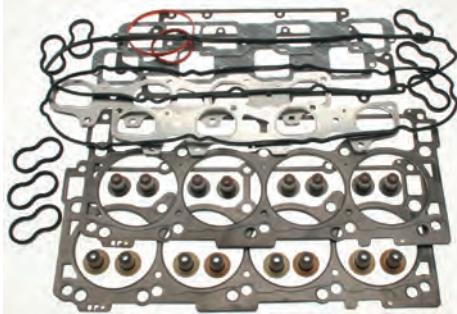

Application	Part #	List Price
2005-10 6.1L Hemi V8 4.125" Bore.....	PRO1023T	\$260.09

BOTTOM END GASKET KIT

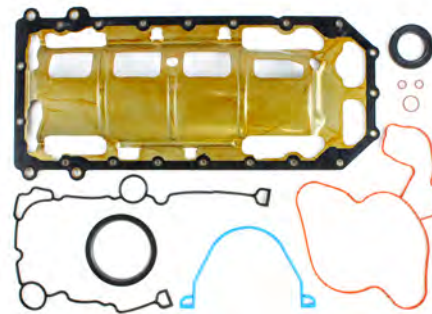

Application	Part #	List Price
2005-10 6.1L Hemi V8.....	PRO1023B	\$154.28

6.2L Hemi V8 2015-Present "Hellcat"

Head Gaskets

NEW!

MLX Head Gasket - Right Side

Bore	Thickness	Pkg Qty	Part #	List Price
4.150"040"1.....	C15292-040	\$120.22

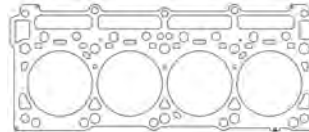

Additional thicknesses available see page 4

NEW!

MLX Head Gasket - Left Side

Bore	Thickness	Pkg Qty	Part #	List Price
4.150"040"1.....	C15293-040	\$120.22

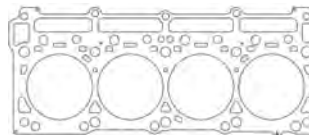

Additional thicknesses available see page 4

6.4L Hemi V8 2011-Present "Apache"

Head Gaskets

MLS Head Gasket - Right Side

Bore	Thickness	Pkg Qty	Part #	List Price
4.120"040"1.....	C5026-040	\$98.23

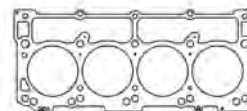

Additional thicknesses available see page 4

MLS Head Gasket - Left Side

Bore	Thickness	Pkg Qty	Part #	List Price
4.120"040"1.....	C5027-040	\$98.23

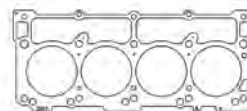



Cometic Gasket - An Exclusive NASCAR Performance Product

CHRYSLER / DODGE

6.4L Hemi V8 2011-Present "Apache"

Head Gaskets

MLX Head Gasket - Right Side				
Bore	Thickness	Pkg Qty	Part #	List Price
4.150"	.040"	1	C15172-040	\$120.22

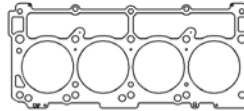

Additional thicknesses available see page 4

MLX Head Gasket - Left Side				
Bore	Thickness	Pkg Qty	Part #	List Price
4.150"	.040"	1	C15173-040	\$120.22

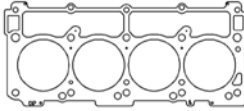

7.0L Hemi V8 2016-Present "Drag Pak"

Head Gaskets

NEW!

MLX Head Gasket - Right Side				
Bore	Thickness	Pkg Qty	Part #	List Price
4.200"	.054"	1	C15391-054	\$115.07

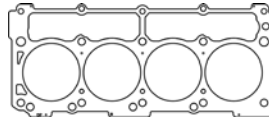

Additional thicknesses available see page 4

NEW!

MLX Head Gasket - Left Side				
Bore	Thickness	Pkg Qty	Part #	List Price
4.200"	.054"	1	C15392-054	\$115.07

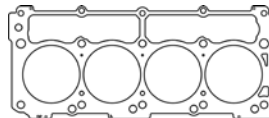

Small Block V8 - A-8 Sprint & A-4 Midget

Head Gaskets

MLS Head Gaskets - A-8 Sprint Block				
Bore	Thickness	Pkg Qty	Part #	List Price
4.165"	.040"	1	C5828-040	\$89.49
4.200"	.040"	1	C5829-040	\$89.49
4.250"	.040"	1	C5830-040	\$89.49

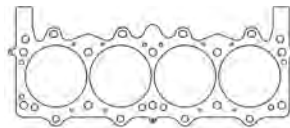

Additional thicknesses available see page 4

MLS Head Gaskets - A-4 Midget Block				
Bore	Thickness	Pkg Qty	Part #	List Price
4.165"	.040"	1	C5831-040	\$89.49
4.200"	.040"	1	C5832-040	\$89.49

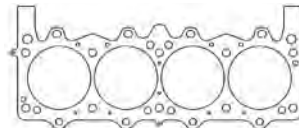

Individual Gaskets

Valve Cover Gasket (sold individually)		
Application	Part #	List Price
Midget & Sprint Head	C5784-060	\$16.59

Oil Pan Gasket Set		
Application	Part #	List Price
Midget Block - .060" AFM	C5596-060	\$25.70

Intake Manifold Gasket		
Application	Part #	List Price
A-4 Midget Intake Gasket	C5590	\$13.46



Cometic Gasket - An Exclusive NASCAR Performance Product

CHRYSLER / DODGE

Small Block V8 - R3 Block w/W2, W7, W8, or W9 Heads

Head Gaskets

MLS Head Gaskets - R3 Block w/W2 Heads

Bore	Thickness	Pkg Qty	Part #	List Price
4.100"	.040"	1	C5567-040	\$89.49
4.200"	.040"	1	C5466-040	\$89.49

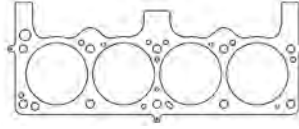

Additional thicknesses available
see page 4

MLS Head Gaskets - R3 Block w/W7, W8, W9 Heads

Bore	Thickness	Pkg Qty	Part #	List Price
4.060"	.040"	1	C5579-040	\$89.49
4.100"	.040"	1	C5580-040	\$89.49
4.165"	.040"	1	C5581-040	\$89.49
4.185"	.040"	1	C5582-040	\$89.49

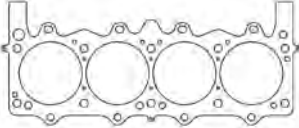

Individual Gaskets

Valve Cover Gaskets (sold individually)

Application	Part #	List Price
W2/W5/W7/W9 Heads	C5568-094	\$19.57
W8 Heads	C5592-094	\$15.94

Thermostat Gasket

Application	Part #	List Price
R3 Block	C5574-018	\$1.13

Intake Manifold Gaskets

Application	Part #	List Price
W2 Heads 1.35" x 2.07"	C5569-060	\$19.57
W7/W8/W9 Heads 1.45" x 2.20"	C5586-031	\$19.57
China Rail Gaskets	C5625-060	\$7.35

Oil Pan Gasket

Application	Part #	List Price
R3 Block - Rails Only	C5575-094	\$24.06

Exhaust Gaskets

Application	Part #	List Price
W2 Heads 1.47" x 1.45"	C5571-064	\$22.06
W7/W8/W9 Heads D-Port	C5593-064	\$23.30

Timing Cover Gasket

Application	Part #	List Price
R3 Block - .018" AFM	C5576-018	\$14.70

Water Pump Gasket

Application	Part #	List Price
R3 Block	C5573-018	\$8.97

Fuel Pump Gasket

Application	Part #	List Price
R3 Block - .031" Fiber	C5642-031	\$2.27

Small Block V8 - R4 Block w/P5 Heads

Head Gaskets

MLS Head Gaskets

Bore	Thickness	Pkg Qty	Part #	List Price
4.200"	.040"	1	C5801-040	\$98.23
4.250"	.040"	1	C5800-040	\$98.23

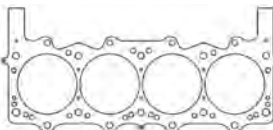

Additional thicknesses available
see page 4

Small Block V8 - R6 Race Block

Head Gaskets

MLX Head Gasket - Right Side

Bore	Thickness	Pkg Qty	Part #	List Price
4.220"	.040"	1	C5670-040	\$115.84

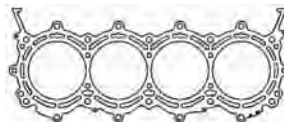

Additional thicknesses available
see page 4

MLX Head Gasket - Left Side

Bore	Thickness	Pkg Qty	Part #	List Price
4.220"	.040"	1	C5671-040	\$115.84

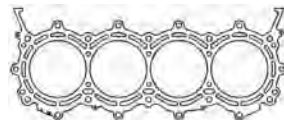



Cometic Gasket - An Exclusive NASCAR Performance Product

CHRYSLER / DODGE

Big Block Wedge 361, 383, 400, 413, 426, & 440ci V8

Head Gaskets

MLS Head Gaskets				
Bore	Thickness	Pkg Qty	Part #	List Price
4.250"	.040"	1	C5459-040	\$98.23
4.350"	.040"	1	C5460-040	\$98.23
4.380"	.040"	1	C5461-040	\$98.23
4.410"	.040"	1	C5462-040	\$98.23
4.500"	.040"	1	C5464-040	\$98.23
4.600"	.040"	1	C5799-040	\$98.23

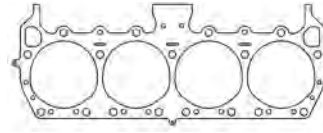

Additional thicknesses available see page 4

NEW!

Copper Head Gaskets				
Bore	Thickness	Pkg Qty	Part #	List Price
4.400"	.043"	1	C15417-043	\$125.30

Individual Gaskets

Valve Cover Gasket (sold individually)		
Application	Part #	List Price
Molded Rubber	C5983	\$22.65

Oil Pan Gasket		
Application	Part #	List Price
Big Block Wedge V8-.060"AFM	C5617-060	\$15.94

Intake Manifold Gaskets		
Application	Part #	List Price
2.31" x 1.23" - .060" KF	C5611-060	\$19.57
China Rail Gaskets	C5612-060	\$7.72

Exhaust Gaskets		
Application	Part #	List Price
1.85" x 1.35" - .064" AM	C5619-064	\$23.30
1.78" x 1.46" - .030" MLS	C5902-030	\$46.51

Water Pump Gaskets		
Application	Part #	List Price
Pump to Block - Pair	C5615-032	\$11.03

Timing Cover Gasket Set		
Application	Part #	List Price
Big Block Wedge V8	C5062	\$28.31

Thermostat Gasket		
Application	Part #	List Price
Big Block Wedge V8	C5616-018	\$1.63

Fuel Pump Gasket		
Application	Part #	List Price
Fuel Pump to Block	C5642-031	\$2.27

Rear Main Seal Kit		
Application	Part #	List Price
2pc Viton	C5686	\$333.57

Gasket Kits

To purchase a complete gasket kit order both top end and bottom end gasket kit

TOP END GASKET KIT

Application	Part #	List Price
Big Block Wedge V8 4.410" Bore	PRO1001T	\$191.57

BOTTOM END GASKET KIT

Application	Part #	List Price
Big Block Wedge V8	PRO1001B	\$72.73



Cometic Gasket - An Exclusive NASCAR Performance Product

CHRYSLER / DODGE

392 Hemi V8 1957-58

Head Gaskets

MLS Head Gaskets

Bore	Thickness	Pkg Qty	Part #	List Price
4.000"	.040"	1	C5210-045	\$98.23
4.100"	.040"	1	C5211-045	\$98.23

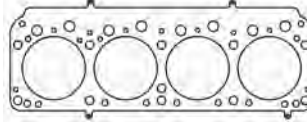

Additional thicknesses available see page 4

NEW!

Copper Head Gaskets

Bore	Thickness	Pkg Qty	Part #	List Price
4.060"	.043"	1	C15418-043	\$112.13

Individual Gaskets

Valve Cover Gaskets

Application	Part #	List Price
392 Hemi - 188" ML (pair)	C5236-188	\$45.31

Oil Pan Gasket Set

Application	Part #	List Price
1958-59 4pc Set	C15055	\$38.09

Intake Manifold Gasket Set

Application	Part #	List Price
Includes Valley Gasket	C5237	\$63.39

Distributor Gasket

Application	Part #	List Price
392 Hemi - .031" Fiber	C5239-031	\$1.68

Exhaust Gaskets

Application	Part #	List Price
1957-58 - .064" AM	C5238-064	\$35.69

Timing Cover Gasket Set

Application	Part #	List Price
1955-59 Early Hemi	C5063	\$28.31

Cooling/Water Pump Gaskets

Application	Part #	List Price
Pump to Block - 4 Pack	C5228-060	\$7.69
Water Outlet	C5229-060	\$4.03
Water Inlet	C5230-032	\$1.63

Carburetor Gasket Kits

Application	Part #	List Price
392 Hemi 2bbl Kit	C5240	\$8.58
392 Hemi 4bbl Kit	C5241	\$14.52

Gasket Kits



To purchase a complete gasket kit order both top end and bottom end gasket kit

TOP END GASKET KIT

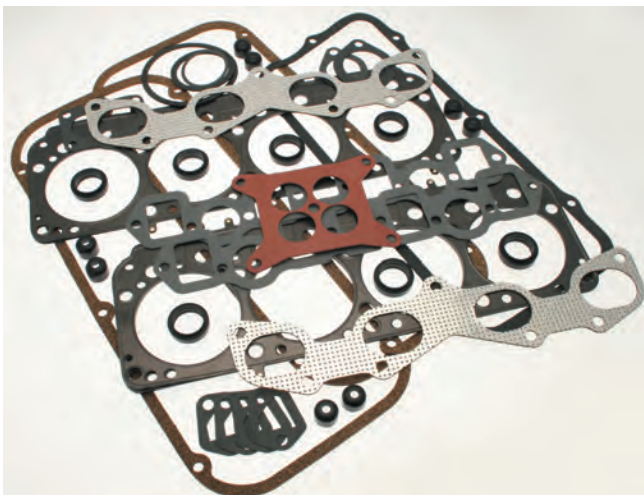

Application	Part #	List Price
392 Hemi V8 1957-58 4.100" Bore	PRO1028T	\$175.09

BOTTOM END GASKET KIT

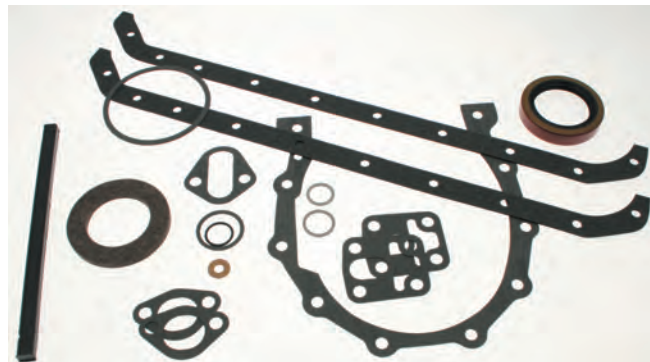

Application	Part #	List Price
392 Hemi V8 1957-58	PRO1028B	\$72.73



Cometic Gasket - An Exclusive NASCAR Performance Product

CHRYSLER / DODGE

426 Hemi 1966 & Later (Gasket bores .060" larger than listed)

Head Gaskets

MLS Head Gaskets				
Bore	Thickness	Pkg Qty	Part #	List Price
4.250"	.040"	1	C5445-040	\$98.23
4.280"	.040"	1	C5454-040	\$98.23
4.310"	.040"	1	C5455-040	\$98.23
4.375"	.040"	1	C5446-040	\$98.23
4.500"	.040"	1	C5447-040	\$98.23

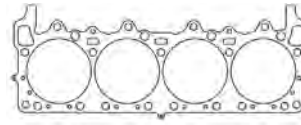

Additional thicknesses available see page 4

NEW!

Copper Head Gaskets				
Bore	Thickness	Pkg Qty	Part #	List Price
4.320"	.043"	1	C15419-043	\$125.30

Individual Gaskets

Valve Cover Gasket (sold individually)		
Application	Part #	List Price
Molded Rubber	C5976	\$22.65

Oil Pump Gasket		
Application	Part #	List Price
426 Hemi	C5604-032	\$4.92

Intake Manifold Gaskets		
Application	Part #	List Price
1.85" x 2.00" - .047" KF	C5598-047	\$19.57

Oil Pan Gasket		
Application	Part #	List Price
426 Hemi - .060" AFM	C5606-060	\$15.94

Exhaust Gaskets		
Application	Part #	List Price
1.84" x 1.89" - .030" MLS	C5965-030	\$40.93

Fuel Pump Gasket		
Application	Part #	List Price
Fuel Pump to Block	C5642-031	\$2.27

Cooling / Water Pump Gaskets		
Application	Part #	List Price
Pump to Block - Pair	C5601-018	\$11.03
Pump to Housing	C5602-032	\$11.03
Thermostat Gasket	C5603-018	\$1.63

Distributor Gasket		
Application	Part #	List Price
426 Hemi	C5607-060	\$1.30

Rear Main Seal Kit		
Application	Part #	List Price
2pc Viton	C5686	\$33.57

Gasket Kits

To purchase a complete gasket kit order both top end and bottom end gasket kit

TOP END GASKET KIT

Application	Part #	List Price
426 Hemi 7.0L 1966-71 4.100" Bore	PRO1021T	\$170.97

BOTTOM END GASKET KIT

Application	Part #	List Price
426 Hemi 7.0L 1966-71	PRO1021B	\$83.75



Cometic Gasket - An Exclusive NASCAR Performance Product

CHRYSLER / DODGE

8.0L V10 1992-Early 96, (Gen 1 Viper)

Head Gaskets

MLS Head Gaskets

Bore	Thickness	Pkg Qty	Part #	List Price
4.030"	.051"	1	C5113-051	\$206.91
4.165"	.051"	1	C5114-051	\$206.91

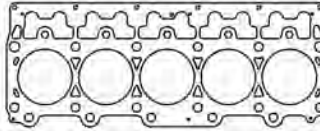

Additional thicknesses available
see page 4

Individual Gaskets

Intake Manifold Gaskets

Application	Part #	List Price
1992+Up - .039" Fiber	C5827-039	\$22.10

Exhaust Manifold Gaskets

Application	Part #	List Price
1992-E96 - .030" MLS	C5679-030	\$33.15

8.0/8.3L V10 Late 1996-07, (Gen 2/3 Viper)

Head Gaskets

MLS Head Gasket

Bore	Thickness	Pkg Qty	Part #	List Price
4.060"	.051"	1	C5814-051	\$130.14
4.125"	.051"	1	C5815-051	\$130.14
4.165"	.051"	1	C5816-051	\$130.14

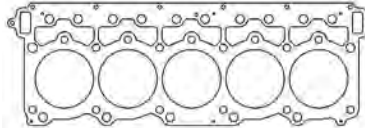

Additional thicknesses available
see page 4

MLX Head Gasket w/1/2" Studs

Bore	Thickness	Pkg Qty	Part #	List Price
4.125"	.054"	1	C5585-054	\$191.97

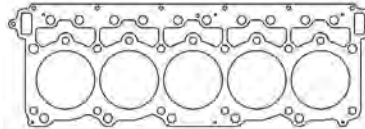

MLX Head Gasket w/9/16" Studs

Bore	Thickness	Pkg Qty	Part #	List Price
4.125"	.054"	1	C5487-054	\$191.97

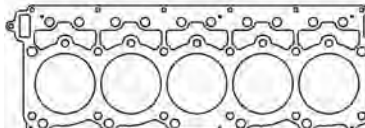

Individual Gaskets

Intake Manifold Gasket

Application	Part #	List Price
1992-Up - .039" Fiber	C5827-039	\$22.10

Exhaust Manifold Gaskets

Application	Part #	List Price
1996-03 Gen 2 - .020" MLS	C5825-020	\$33.15
2004-05 Gen 3 - .030" MLS	C5865-030	\$33.15

8.4L V10 2008-10, (Gen 4 Viper)

Head Gaskets

MLS Head Gasket

Bore	Thickness	Pkg Qty	Part #	List Price
4.125"	.045"	1	C5107-045	\$130.14

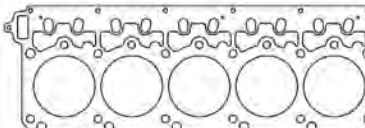

Additional thicknesses available
see page 4

MLX Head Gasket w/9/16" Studs

Bore	Thickness	Pkg Qty	Part #	List Price
4.125"	.054"	1	C5504-054	\$191.97

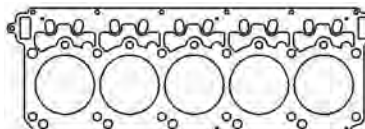

Individual Gaskets

Exhaust Manifold Gasket Set

Application	Part #	List Price
2010 - Up MLS	C15150-040	\$53.96



Cometic Gasket - An Exclusive NASCAR Performance Product

CHRYSLER / DODGE

8.4L V10 2013-17 (Gen 5 Viper)

Head Gaskets

NEW!

MLS Head Gasket - Left Side

Bore	Thickness	Pkg Qty	Part #	List Price
4.125"	.040"	1	C15377-040	\$130.14

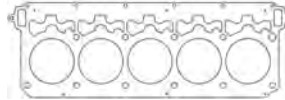

Additional thicknesses available
see page 4

NEW!

MLS Head Gasket - Right Side

Bore	Thickness	Pkg Qty	Part #	List Price
4.125"	.040"	1	C15378-040	\$130.14

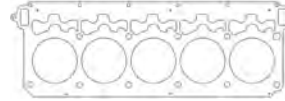

Prostock Hemi 500ci V8

Head Gaskets

MLS Head Gaskets - Gen1 Hemi 99

Bore	Thickness	Pkg Qty	Part #	List Price
4.660"	.051"	1	C5444-051	\$130.14
4.685"	.051"	1	C5443-051	\$130.14
4.700"	.051"	1	C5442-051	\$130.14
4.720"	.051"	1	C5438-051	\$130.14

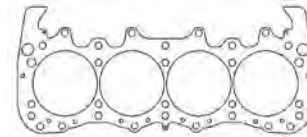

Additional thicknesses available
see page 4

MLS Head Gaskets - Gen2 "DPS2"

Bore	Thickness	Pkg Qty	Part #	List Price
4.750"	.050"	1	C5045-050	\$161.17

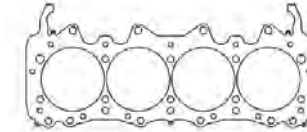

CUMMINS

3.9L 4BT Diesel 4cyl 1983+

Head Gasket

MLX Head Gasket

Bore	Thickness	Pkg Qty	Part #	List Price
4.100"	.061"	1	C5591-061	\$118.97

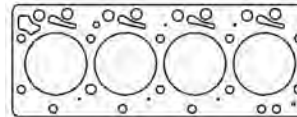

Additional thicknesses available
see page 4

Individual Gaskets

Valve Cover Gasket Set

Application	Part #	List Price
3.9L 4BT	C15056	\$22.65

Thermostat Housing Seal

Application	Part #	List Price
3.9L 4BT	C15059	\$2.46

Intake Manifold Gaskets

Application	Part #	List Price
3.9L 4BT	C15057	\$10.89

Oil Pan Gasket

Application	Part #	List Price
3.9L 4BT - .031" Fiber	C15060	\$31.37

Exhaust Manifold Gaskets Set

Application	Part #	List Price
3.9L 4BT - 4 Pack	C15058	\$22.79

Rear Main Seal

Application	Part #	List Price
3.9L 4BT	C15062	\$74.63

Valve Stem Seal

Application	Part #	List Price
8x12.3x12x17 Viton - Need 8	3164V	\$1.90

Pushrod Cover Gasket

Application	Part #	List Price
3.9L 4BT 1983-97	C15064	\$14.75

Timing Cover Seal

Application	Part #	List Price
3.9L 4BT	C15063	\$73.12

Fuel Pump Gaskets

Application	Part #	List Price
Fuel Pump Gasket	C5389-032	\$1.78
Injection Pump Gasket	C15061	\$3.91

Water Pump Gasket

Application	Part #	List Price
3.9L 4BT 1983-97 - O-Ring	C15065	\$1.70

See page 40 for StreetPro gasket kits



Cometic Gasket - An Exclusive NASCAR Performance Product

CUMMINS

3.9L 4BT Diesel 4cyl 1983+

Gasket Kits



To purchase a complete gasket kit order both top end and bottom end gasket kit

TOP END GASKET KIT

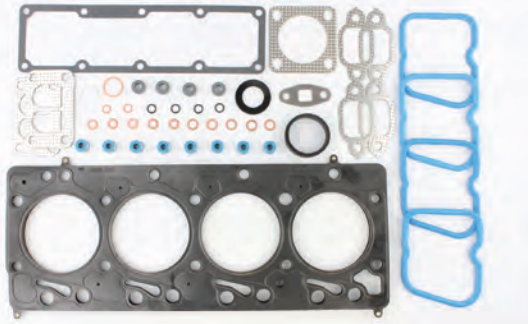

Application	Part #	List Price
3.9L 4BT 4cyl Diesel 4.100" Bore	PRO3000T	\$374.87

BOTTOM END GASKET KIT



Application	Part #	List Price
3.9L 4BT 4cyl Diesel.....	PRO3000B	\$242.04

5.9L 12v 6BT Inline 6 Diesel 1992-98

Head Gasket

MLX Head Gasket

Bore	Thickness	Pkg Qty	Part #	List Price
4.100"061"	1.....	C5955-061	\$234.46

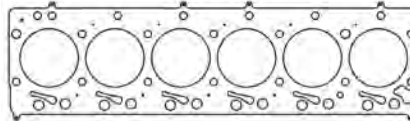

Additional thicknesses available see page 4

Individual Gaskets

Valve Cover Gasket Set

Application	Part #	List Price
5.9L 6BT 1992-98	C15066	\$39.64

Thermostat Housing Seal

Application	Part #	List Price
5.9L 6BT 1992-98	C15059	\$2.46

Intake Manifold Gasket Set

Application	Part #	List Price
5.9L 6BT 1992-98	C15067	\$44.27

Oil Pan Gasket

Application	Part #	List Price
5.9L 6BT 1992-98	C15068	\$37.89

Exhaust Manifold Gaskets Set

Application	Part #	List Price
5.9L 6BT 1992-98 - .040" MLS	C5725-040	\$49.74

Rear Main Seal

Application	Part #	List Price
5.9L 6BT 1992-98	C15062	\$74.63

Valve Stem Seal

Application	Part #	List Price
8x12.3x12x17 Viton - Need 12	3164V	\$1.90

Pushrod Cover Gasket

Application	Part #	List Price
5.9L 6BT 1989-99	C15069	\$14.13

Timing Cover Seal

Application	Part #	List Price
5.9L 6BT 1992-98	C15063	\$75.31

Fuel Pump Gasket

Application	Part #	List Price
Fuel Pump Gasket	C5389-032	\$1.79
Injection Pump Gasket	C15061	\$3.91

Water Pump Gasket

Application	Part #	List Price
3.9L 4BT 1983-98 - O-Ring	C15065	\$1.70

See page 41 for StreetPro gasket kits



Cometic Gasket - An Exclusive NASCAR Performance Product

CUMMINS

5.9L 12v 6BT Inline 6 Diesel 1992-97

Gasket Kits



To purchase a complete gasket kit order both top end and bottom end gasket kit

TOP END GASKET KIT

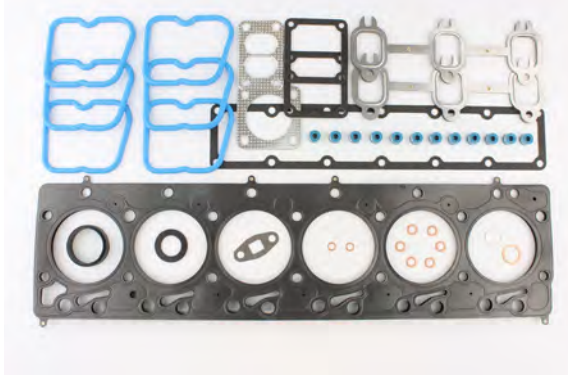

Application	Part #	List Price
5.9L 6BT I6 Diesel 92-98 4.100" Bore	PRO3001T	\$374.87

BOTTOM END GASKET KIT



Application	Part #	List Price
5.9L 6BT I6 Diesel 92-98	PRO3001B	\$242.04

5.9L 24v ISB Inline 6 Diesel 1998.5-02

Head Gasket

MLX Head Gasket

Bore	Thickness	Pkg Qty	Part #	List Price
4.100"	.061"	1	C5855-061	\$234.46

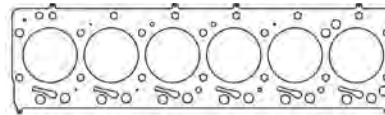

Additional thicknesses available see page 4

Individual Gaskets

Valve Cover Gasket Set

Application	Part #	List Price
5.9L ISB 1998.5-02	C5614	\$45.31

Oil Pan Gasket

Application	Part #	List Price
5.9L 6BT 1998.5-02	C15068	\$37.89

Intake Manifold Gasket Set

Application	Part #	List Price
5.9L ISB 1998.5-02	C15067	\$44.27

Rear Main Seal

Application	Part #	List Price
5.9L 6BT 1998.5-02	C15062	\$74.63

Exhaust Manifold Gaskets Set

Application	Part #	List Price
5.9L ISB 1998.5-02	C5726-040	\$49.74

Pushrod Cover Gasket

Application	Part #	List Price
5.9L 6BT 1998.5-02	C15069	\$14.13

Valve Stem Seals

Application	Part #	List Price
Intake VSS - Yellow (Need 12)	3214V	\$2.25
Exhaust VSS-Green(Need 12)	3215V	\$2.94

Water Pump Gasket

Application	Part #	List Price
3.9L 4BT 1998.5-02 - O-Ring	C15065	\$1.70

Timing Cover Seal

Application	Part #	List Price
5.9L 6BT 1998.5-02	C15063	\$75.31

See page 42 for StreetPro gasket kits



Cometic Gasket - An Exclusive NASCAR Performance Product

CUMMINS

5.9L 24v ISB Inline 6 Diesel 1998.5-02

Gasket Kit



To purchase a complete gasket kit order both top end and bottom end gasket kit

TOP END GASKET KIT

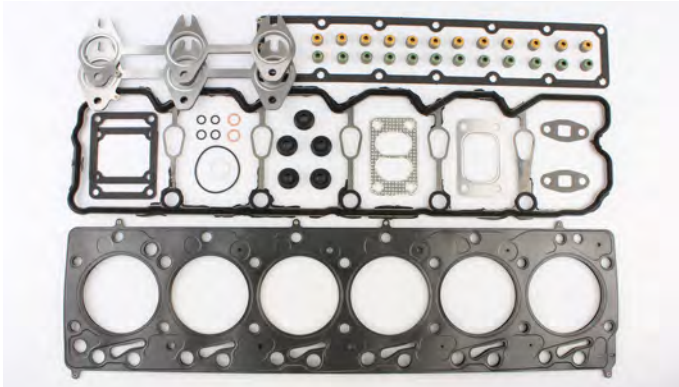

Application	Part #	List Price
5.9L 24v ISB 6cyl 1998.5-02	PRO3002T	\$407.00

BOTTOM END GASKET KIT

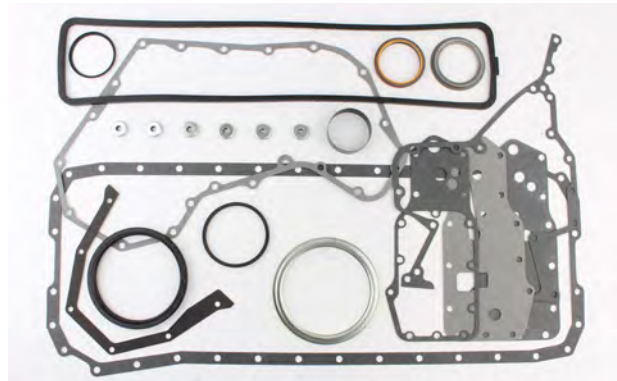

Application	Part #	List Price
5.9L 24v ISB 6cyl 1998.5-02	PRO3002B	\$171.34

5.9L 24v ISB Common Rail Inline 6 Diesel 2003-07

Head Gasket

MLX Head Gasket

Bore	Thickness	Pkg Qty	Part #	List Price
4.100"061"	1	C5597-061	\$234.46

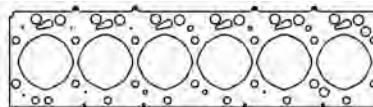

Additional thicknesses available see page 4

Individual Gaskets

Fuel Injector Seal Kit

Application	Part #	List Price
5.9L Common Rail 2003-07	C15072	\$42.65

Valve Stem Seals

Application	Part #	List Price
Intake VSS - Yellow (Need 12)	3218V	\$1.85
Exhaust VSS-Green(Need 12)	3219V	\$1.85

Valve Cover Gasket Set

Application	Part #	List Price
5.9L Common Rail 2003-07	C15070	\$38.64

Pushrod Cover Gasket

Application	Part #	List Price
5.9L Common Rail 2003-07	C15071	\$14.27

Intake Manifold Gasket Set

Application	Part #	List Price
5.9L Common Rail 2003-07	C15067	\$44.27

Thermostat Seal

Application	Part #	List Price
5.9L Common Rail 2003-07	C15073	\$7.11

Exhaust Manifold Gaskets Set

Application	Part #	List Price
5.9L Common Rail 2003-07	C5726-040	\$49.74

See page 43 for StreetPro gasket kits



Cometic Gasket - An Exclusive NASCAR Performance Product

CUMMINS

5.9L 24v ISB Common Rail Inline 6 Diesel 2003-07

Gasket Kit



TOP END GASKET KIT

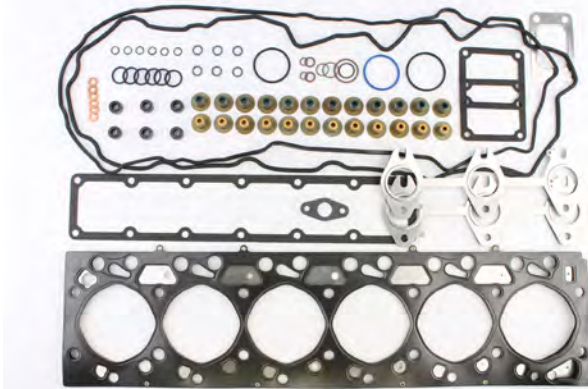

Application	Part #	List Price
5.9L 24v Common Rail 03-07.....	PRO3003T	\$434.86

6.7L 24v ISB Inline 6 Diesel 2007.5+Up

Head Gasket

MLX Head Gasket				
Bore	Thickness	Pkg Qty	Part #	List Price
4.312"052"1.....	C5609-052	\$234.46

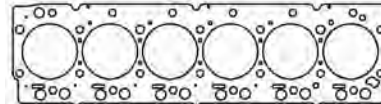

Additional thicknesses available see page 4

Individual Gaskets

Valve Stem Seal		
Application	Part #	List Price
VSS - Yellow (Need 24).....	3218V	\$1.85

Rear Main Seal		
Application	Part #	List Price
6.7L 24v ISB 2007.5+Up	C15062	\$74.63

Intake Gasket Set		
Application	Part #	List Price
6.7L 24v ISB 2007.5+Up	C15076	\$49.74

Timing Cover Seal		
Application	Part #	List Price
6.7L 24v ISB 2007.5+Up	C15063	\$75.31

Exhaust Manifold Gaskets Set		
Application	Part #	List Price
6.7L 24v ISB 2007.5+Up (MLS).....	C5726-040	\$49.74

Water Pump Gasket		
Application	Part #	List Price
6.7L 24v ISB 2007.5+Up	C15065	\$1.70

Thermostat Seal		
Application	Part #	List Price
6.7L 24v ISB 2007.5+Up	C15073	\$7.11

Oil Cooler Gasket Set		
Application	Part #	List Price
6.7L 24v ISB 2007.5+Up	C15075	\$44.89

Oil Pan Gasket		
Application	Part #	List Price
6.7L 24v ISB 2007.5+Up	C15074	\$58.06

Pushrod Cover Gasket		
Application	Part #	List Price
6.7L 24v ISB 2007.5+Up	C15071	\$14.27

See page 44 for StreetPro gasket kits



Cometic Gasket - An Exclusive NASCAR Performance Product

CUMMINS

6.7L 24v ISB Inline 6 Diesel 2007.5+Up

Gasket Kits



To purchase a complete gasket kit order both top end and bottom end gasket kit

TOP END GASKET KIT

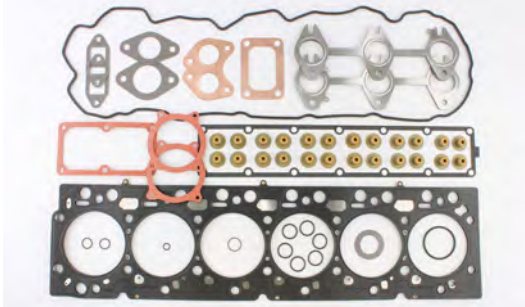

Application	Part #	List Price
6.7L 24v ISB 6cyl 2007.5+Up 4.312" Bore	PRO3004T	\$434.86

BOTTOM END GASKET KIT



Application	Part #	List Price
6.7L 24v ISB 6cyl 2007.5+Up	PRO3004B	\$208.83

FORD

1.6L Sigma 2011-16

Head Gasket

MLX Head Gasket

Bore	Thickness	Pkg Qty	Part #	List Price
82mm028"	1	C4963-028	\$115.84

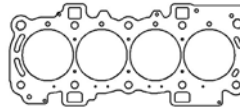

Additional thicknesses available
see page 4

1.6L & 1.8L CVH 4cyl 1985-93

Head Gasket

MLS Head Gasket

Bore	Thickness	Pkg Qty	Part #	List Price
83mm051"	1	C5756-051	\$98.23

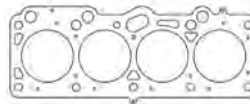

Additional thicknesses available
see page 4

1.9L CVH 4cyl 1985-96

Head Gasket

MLS Head Gasket

Bore	Thickness	Pkg Qty	Part #	List Price
82mm051"	1	C5136-051	\$98.23

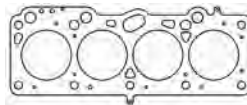

Additional thicknesses available
see page 4

2.0L SOHC/DOHC NEP/YB Group A

Head Gasket

MLS Head Gasket

Bore	Thickness	Pkg Qty	Part #	List Price
92.5mm040"	1	C4218-040	\$95.53

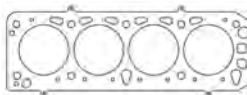

Additional thicknesses available
see page 4

See page 45 for additional gaskets



Cometic Gasket - An Exclusive NASCAR Performance Product

FORD

2.0L SOHC/DOHC NEP/YB Group A

Individual Gaskets

Intake Gasket Set		
Application	Part #	List Price
Cosworth YB	C4502	\$43.63

Oil Pan Gasket		
Application	Part #	List Price
Cosworth YB Rails only	C4640	\$16.44

Exhaust Manifold Gasket Set		
Application	Part #	List Price
Cosworth YB	C4334	\$17.52

Front Cover Gasket		
Application	Part #	List Price
Cosworth YB.....	C4641	\$9.79

Valve Cover Gaskets		
Application	Part #	List Price
Early YB Engine - .060" AFM.....	C4635	\$29.51
Late YB Engine - .060" AFM.....	C4636	\$29.51

Cooling/Water Pump Gasket		
Application	Part #	List Price
Water Pump Gasket	C4637	\$5.58
Water Outlet Gasket	C4638	\$2.48
Thermostat Gasket.....	C4639	\$2.33

2.0L ZETEC DOHC 4cyl 1995-04

Head Gasket

MLS Head Gasket				
Bore	Thickness	Pkg Qty	Part #	List Price
87mm027"	1.....	C4279-027	\$89.49

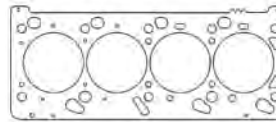

Additional thicknesses available see page 4

Individual Gaskets

Valve Cover Gaskets		
Application	Part #	List Price
2.0L Zetec DOHC 1995-97	C4643	\$28.31
2.0L Zetec DOHC 1998-04.....	C4644	\$28.31

Valve Stem Seals		
Application	Part #	List Price
2.0L Zetec 1995-97 (16pk)	3181V-16	\$44.56
2.0L Zetec 1998-04 (16pk)	3182V-16	\$47.99

Exhaust Manifold Gasket Set		
Application	Part #	List Price
2.0L Zetec 1994-04	C4645	\$18.44

Oil Pan Gasket		
Application	Part #	List Price
2.0L Zetec 1995-04	C4649	\$26.39

Intake Gasket Sets		
Application	Part #	List Price
2.0L Zetec 1998-04	C4646	\$15.05
2.0L Zetec 1995-97	C4647	\$45.18

Thermostat Gaskets		
Application	Part #	List Price
2.0L Zetec 1995-04 - Seal	C4651	\$1.85
2.0L Zetec 1995-04 - Housing	C4652	\$4.72

Cam Seal		
Application	Part #	List Price
2.0L Zetec 1994-04	C4648	\$13.31

Rear Main Seal Set		
Application	Part #	List Price
2.0L Zetec 1995-04	C4650	\$16.42



Cometic Gasket - An Exclusive NASCAR Performance Product

FORD

2.0L ZETEC DOHC 4cyl 1995-04

Gasket Kits



To purchase a complete gasket kit order both top end and bottom end gasket kit

TOP END GASKET KITS

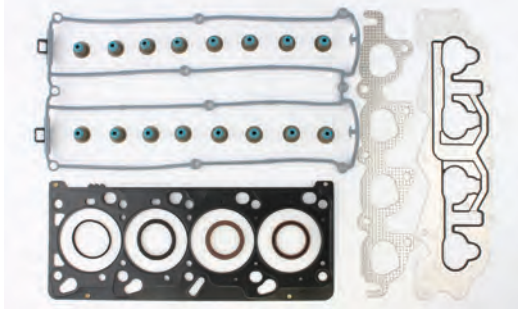

Application	Part #	List Price
2.0L Zetec DOHC 1995-97 87mm Bore	PRO2029T	\$235.95
2.0L Zetec DOHC 1998-04 87mm Bore	PRO2030T	\$235.95

BOTTOM END GASKET KITS

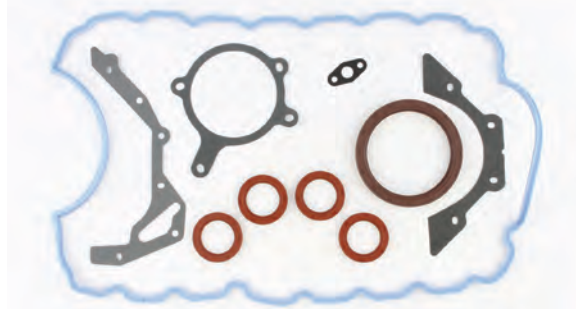

Application	Part #	List Price
2.0L Zetec DOHC 1995-97	PRO2029B	\$109.21
2.0L Zetec DOHC 1998-04	PRO2030B	\$109.21

2.3L "2300" SOHC 1974-97 4cyl

Head Gaskets

MLS Head Gaskets

Bore	Thickness	Pkg Qty	Part #	List Price
3.830"	.040"	1	C5369-040	\$73.62
3.940"	.040"	1	C5709-040	\$73.62

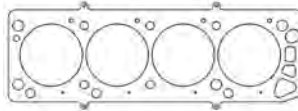

Additional thicknesses available see page 4

Individual Gaskets

Valve Cover Gaskets

Application	Part #	List Price
2300 2.3L 1974-93	C4653	\$22.65

Exhaust Manifold Gasket Set

Application	Part #	List Price
2300 2.3L 1974-93	C5372-064	\$15.94

Intake Gasket Set

Application	Part #	List Price
2300 2.3L	C5371-060	\$13.52

Oil Pan Gaskets

Application	Part #	List Price
2300 2.3L 1974-2/19/86	C5373	\$17.00
2300 2.3L 2/20/86-1990	C4669	\$26.62
2300 2.3L 1991-92	C4741	\$20.90
2300 2.3L 1993	C4778	\$20.90

Valve Stem Seals

Application	Part #	List Price
2300 2.3L 1974-93 (need 8)	3168V	\$2.36

Water Pump Gasket

Application	Part #	List Price
2300 2.3L 1974-93	C4654	\$2.46

Rear Main Seal Sets

Application	Part #	List Price
2300 2.3L 1974-81 2pc	C5688	\$28.22
2300 2.3L 1982-93 1pc	C5189	\$17.78



Cometic Gasket - An Exclusive NASCAR Performance Product

FORD

2.3L "2300" SOHC 1974-97 4cyl

Gasket Kits



To purchase a complete gasket kit order both top end and bottom end gasket kit

TOP END GASKET KIT

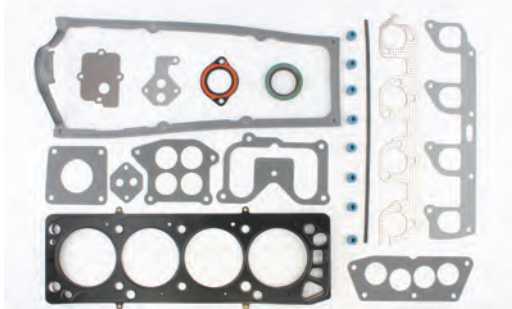

Application	Part #	List Price
2300 2.3L 1974-97 3.830" Bore.....	PRO2031T	\$196.62

BOTTOM END GASKET KIT

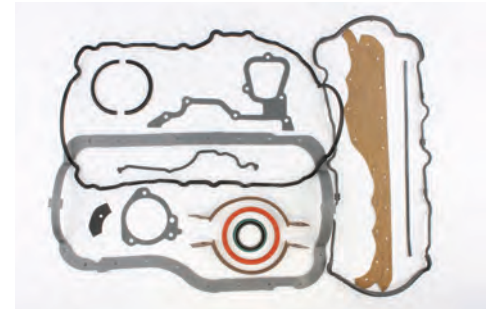

Application	Part #	List Price
2300 2.3L 1974-97	PRO2031B	\$213.00

2.0L 2012-15 EcoBoost DOHC

Head Gasket

NEW!

MLS Head Gasket

Bore	Thickness	Pkg Qty	Part #	List Price
89mm034"1	C15317-040	\$98.23

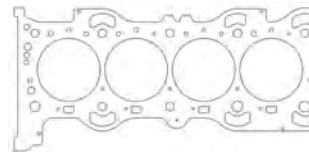

Additional thicknesses available see page 4

2.3L 2016-17 EcoBoost DOHC: 2016-2017 Ford Focus RS

Head Gasket

NEW!

MLS Head Gasket

Bore	Thickness	Pkg Qty	Part #	List Price
89mm040"1	C15249-040	\$115.84

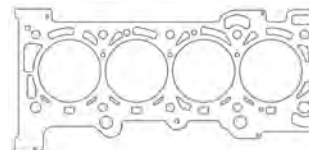

Additional thicknesses available see page 4

2.0L 2003-11 & 2.3L 2003-08 Duratec DOHC

Head Gaskets

MLS Head Gasket

Bore	Thickness	Pkg Qty	Part #	List Price
89.5mm018"1	C5843-018	\$98.23
92mm018"1	C5842-018	\$98.23

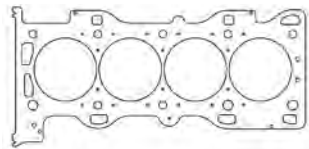

Additional thicknesses available see page 4

Individual Gaskets

Intake Gasket Set

Application	Part #	List Price
2.3L Duratec 2003-08.....	C4842-060	\$18.32

Exhaust Manifold Gaskets

Application	Part #	List Price
2.3L Duratec (w/ extra port).....	C4840-064	\$24.54
2.3L Duratec (w/o extra port).....	C4841-064	\$24.54



Cometic Gasket - An Exclusive NASCAR Performance Product

FORD

2.5L Duratec DOHC 2009 - Present

Head Gasket

MLS Head Gasket

Bore	Thickness	Pkg Qty	Part #	List Price
90mm	.040"	1	C5906-040	\$98.23

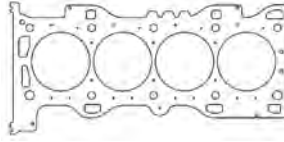

Additional thicknesses available see page 4

3.5L EcoBoost V6 2010-Present

Head Gaskets

MLX Head Gasket - Right Side

Bore	Thickness	Pkg Qty	Part #	List Price
92.5mm	.040"	1	C5452-040	\$97.98

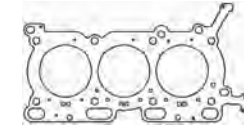

Additional thicknesses available see page 4

MLX Head Gasket - Left Side

Bore	Thickness	Pkg Qty	Part #	List Price
92.5mm	.040"	1	C5453-040	\$97.98

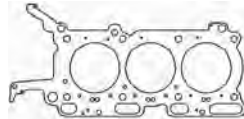

3.9L AJ35 DOHC V8 2003-06

Head Gaskets

MLS Head Gasket - Right Side

Bore	Thickness	Pkg Qty	Part #	List Price
87mm	.030"	1	C5770-030	\$100.67
93mm	.030"	1	C5771-030	\$100.67

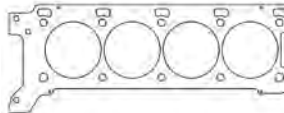

Additional thicknesses available see page 4

MLS Head Gasket - Left Side

Bore	Thickness	Pkg Qty	Part #	List Price
87mm	.030"	1	C5772-030	\$100.67
93mm	.030"	1	C5773-030	\$100.67

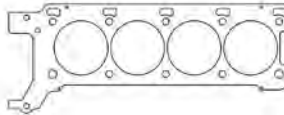

4.0L Falcon Inline 6 1998-02

Head Gasket

MLS Head Gasket

Bore	Thickness	Pkg Qty	Part #	List Price
3.695"	.040"	1	C4597-040	\$175.38



Additional thicknesses available see page 4

4.0L V6 1997-2010

Head Gaskets

NEW!

MLS Head Gasket - Left Side

Bore	Thickness	Pkg Qty	Part #	List Price
103mm	.040"	1	C15382-040	\$96.70

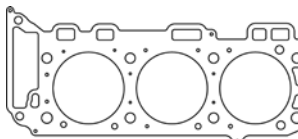

Additional thicknesses available see page 4

NEW!

MLS Head Gasket - Right Side

Bore	Thickness	Pkg Qty	Part #	List Price
103mm	.040"	1	C15381-040	\$96.70

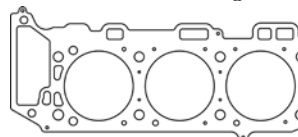



Cometic Gasket - An Exclusive NASCAR Performance Product

FORD

4.0L Barra Inline 6 DOHC 2002-Present

Head Gasket

MLS Head Gasket				
Bore	Thickness	Pkg Qty	Part #	List Price
93mm	.030"	1	C5957-030	\$175.38

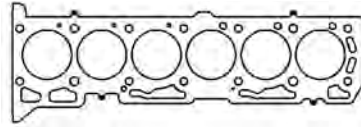

Additional thicknesses available see page 4

4.6L & 5.4L SOHC/DOHC Modular V8

Head Gaskets

MLS Head Gaskets - Right Side				
Bore	Thickness	Pkg Qty	Part #	List Price
92mm	.030"	1	C5119-030	\$135.07
94mm	.030"	1	C5503-030	\$135.07

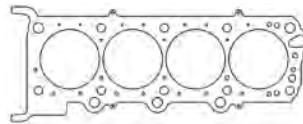

Additional thicknesses available see page 4

MLS Head Gaskets - Left Side				
Bore	Thickness	Pkg Qty	Part #	List Price
92mm	.030"	1	C5118-030	\$135.07
94mm	.030"	1	C5502-030	\$135.07

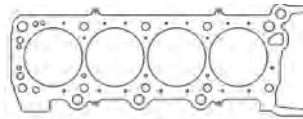

MLX Head Gaskets - Right Side				
Bore	Thickness	Pkg Qty	Part #	List Price
92mm	.032"	1	C15258-032	\$171.61
94mm	.032"	1	C15260-032	\$171.61

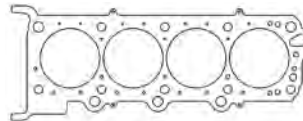

MLX Head Gaskets - Left Side				
Bore	Thickness	Pkg Qty	Part #	List Price
92mm	.032"	1	C15259-032	\$171.61
94mm	.032"	1	C15261-032	\$171.61

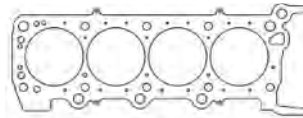

Individual Gaskets

Valve Cover Gasket Sets		
Application	Part #	List Price
4.6L DOHC 1996-98	C5177	\$67.97
4.6L SOHC 1996-04	C5178	\$45.31
4.6L SOHC 2002-04 Truck	C5179	\$45.31

Throttle Body Gaskets		
Application	Part #	List Price
SOHC 1996-01 Spacer-TB	C15078	\$3.40
DOHC 1996-98 .020" Fiber	C15079	\$5.10
SOHC 1996-00 Spacer-Manifold	C15080	\$11.60
4.6L SOHC 1999-11 - Rubber	C15081	\$7.10

Intake Gaskets		
Application	Part #	List Price
4.6L DOHC 1998	C5180	\$27.77
4.6L DOHC 1996-97	C5181	\$42.44
4.6L DOHC 1996-98 - Cover	C5182	\$44.06
4.6L DOHC 1996-98 - Plenum	C5183	\$53.57
4.6L SOHC 1995-00	C5184	\$33.19
4.6L SOHC 2000-04 Truck	C5185	\$44.32
4.6L SOHC 00-04 Truck Plenum	C5186	\$30.67
4.6L SOHC 97-99 Truck Plenum	C5187	\$28.27

Oil Pan Gasket		
Application	Part #	List Price
4.6/5.4L 1996-04	C5188	\$36.59

Exhaust Gaskets		
Application	Part #	List Price
4.6/5.4L SOHC 1991-01	C5853-030	\$35.12
4.6L DOHC 1993-99	C5012-030	\$39.80
5.4L Shelby Mustang 2007	C5805-030	\$44.32

Rear Main Seal		
Application	Part #	List Price
4.6/5.4L 1996-04 - 1pc	C5189	\$17.78

Front Crank Seals		
Application	Part #	List Price
4.6/5.4L SOHC/DOHC 1996-99	C5192	\$19.16
4.6/5.4L SOHC 2000-04	C5191	\$13.62

Water Pump O-Ring		
Application	Part #	List Price
4.6/5.4L SOHC/DOHC 1992-09	C5190	\$4.68



Cometic Gasket - An Exclusive NASCAR Performance Product

FORD

4.6L & 5.4L SOHC/DOHC Modular V8

Gasket Kits



To purchase a complete gasket kit order both top end and bottom end gasket kit

TOP END GASKET KITS



BOTTOM END GASKET KITS

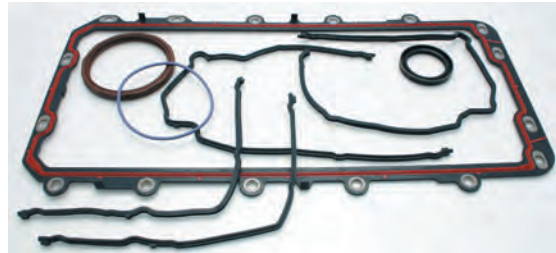

Application	Part #	List Price
4.6L DOHC 1996-98 92mm Bore	PRO1017T	\$411.99
4.6L SOHC 1996-98 92mm Bore	PRO1018T	\$263.67
4.6L SOHC 1999-04 92mm Bore	PRO1019T	\$232.67
4.6L SOHC 1997-04 Truck 92mm Bore.....	PRO1020T	\$263.67

Application	Part #	List Price
4.6L DOHC 1996-98	PRO1017B	\$77.14
4.6L SOHC 1996-98	PRO1018B	\$88.16
4.6L SOHC 1999-04	PRO1019B	\$99.18
4.6L SOHC 1997-04 Truck	PRO1020B	\$159.46

4.6L SOHC 3v Heads Modular 2005-10

Head Gaskets

MLS Head Gasket - Right Side

Bore	Thickness	Pkg Qty	Part #	List Price
94mm030"	1	C5970-030	\$135.07

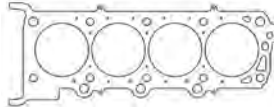

Additional thicknesses available
see page 4

MLS Head Gasket - Left Side

Bore	Thickness	Pkg Qty	Part #	List Price
94mm030"	1	C5969-030	\$135.07

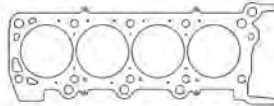

Individual Gaskets

Exhaust Gaskets

Application	Part #	List Price
4.6/5.4L 3V Heads - MLS D-Port.....	C5997-030	\$39.03
4.6/5.4L 3V Heads - MLS	C5852-030	\$39.03

5.4L SOHC 3v Heads Modular 2004-14

Head Gaskets

MLS Head Gasket - Right Side

Bore	Thickness	Pkg Qty	Part #	List Price
94mm030"	1	C5972-030	\$135.07

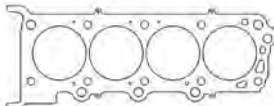

Additional thicknesses available
see page 4

MLS Head Gasket - Left Side

Bore	Thickness	Pkg Qty	Part #	List Price
94mm030"	1	C5971-030	\$135.07

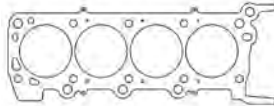

Individual Gaskets

Exhaust Gaskets

Application	Part #	List Price
4.6/5.4L 3V Heads - MLS D-Port.....	C5997-030	\$39.03
4.6/5.4L 3V Heads - MLS	C5852-030	\$39.03



Cometic Gasket - An Exclusive NASCAR Performance Product

FORD

5.0L "Coyote" DOHC Modular V8 2011-14

Head Gaskets

MLS Head Gasket - Left Side				
Bore	Thickness	Pkg Qty	Part #	List Price
94mm040"1	C5287-040	\$135.07

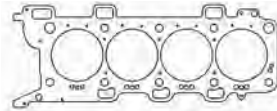

Additional thicknesses available see page 4

MLS Head Gasket - Right Side				
Bore	Thickness	Pkg Qty	Part #	List Price
94mm040"1	C5286-040	\$135.07

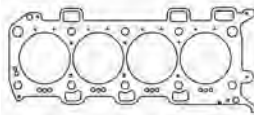

NEW!

MLX Head Gasket - Left Side				
Bore	Thickness	Pkg Qty	Part #	List Price
94mm040"1	C15368-040	\$166.61

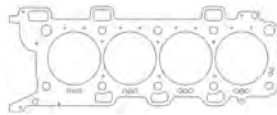

NEW!

MLX Head Gasket - Right Side				
Bore	Thickness	Pkg Qty	Part #	List Price
94mm040"1	C15367-040	\$166.61



Individual Gaskets

Exhaust Gaskets			
Application	Part #	List Price	
5.0L DOHC Coyote - MLS	C5392-030	\$46.33	

5.0L "Coyote" DOHC Modular V8 2015-17

Head Gaskets

MLS Head Gasket - Left Side				
Bore	Thickness	Pkg Qty	Part #	List Price
94mm040"1	C15370-040	\$135.07
94mm045"1	C15370-045	\$135.07
94mm051"1	C15370-051	\$135.07
94mm070"1	C15370-070	\$166.61



Additional thicknesses available see page 4

MLS Head Gasket - Right Side				
Bore	Thickness	Pkg Qty	Part #	List Price
94mm040"1	C15369-040	\$135.07
94mm045"1	C15369-045	\$135.07
94mm051"1	C15369-051	\$135.07
94mm070"1	C15369-070	\$166.61



NEW!

MLX Head Gasket - Left Side				
Bore	Thickness	Pkg Qty	Part #	List Price
94mm040"1	C15366-040	\$166.61



NEW!

MLX Head Gasket - Right Side				
Bore	Thickness	Pkg Qty	Part #	List Price
94mm040"1	C15365-040	\$166.61



Individual Gaskets

Exhaust Gaskets			
Application	Part #	List Price	
5.0L DOHC Coyote - MLS	C5392-030	\$46.53	



Cometic Gasket - An Exclusive NASCAR Performance Product

FORD

5.2L "Voodoo" DOHC Modular V8 2015-2018

Head Gaskets

NEW!

MLS Head Gasket - Left Side

Bore	Thickness	Pkg Qty	Part #	List Price
95mm	0.036	1	C15388-036	\$135.07

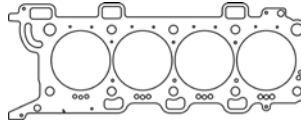

Additional thicknesses available see page 4

NEW!

MLS Head Gasket - Right Side

Bore	Thickness	Pkg Qty	Part #	List Price
95mm	0.036	1	C15387-036	\$135.07

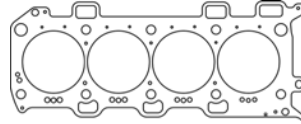

5.8L "Trinity" DOHC Modular V8 2013-14

Head Gaskets

MLX Head Gasket - Left Side

Bore	Thickness	Pkg Qty	Part #	List Price
95.25mm	0.051"	1	C5017-051	\$166.61

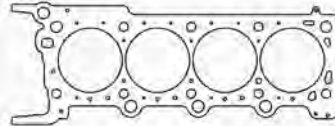

Additional thicknesses available see page 4

MLX Head Gasket - Right Side

Bore	Thickness	Pkg Qty	Part #	List Price
95.25mm	0.030"	1	C5018-051	\$166.61

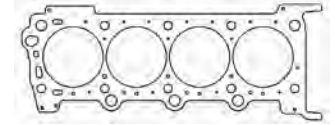

4.6/5.4L 2v/4v Modular V8 w/Darton Solid Sleeves

Head Gaskets

MLS Head Gasket - Left Side

Bore	Thickness	Pkg Qty	Part #	List Price
95.25mm	0.040"	1	C5856-040	\$135.07

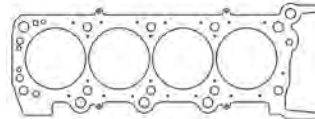

Additional thicknesses available see page 4

MLS Head Gasket - Right Side

Bore	Thickness	Pkg Qty	Part #	List Price
95.25mm	0.030"	1	C5857-040	\$135.07

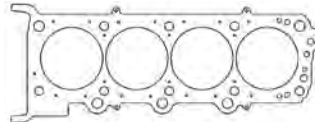

4.6/5.4L 2v/4v Modular V8 w/Darton M.I.D. Sleeves

Head Gaskets

MLS Head Gasket - Left Side

Bore	Thickness	Pkg Qty	Part #	List Price
95.25mm	0.040"	1	C5858-040	\$135.07

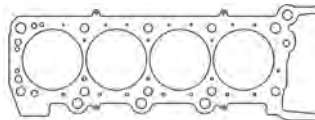

Additional thicknesses available see page 4

MLS Head Gasket - Right Side

Bore	Thickness	Pkg Qty	Part #	List Price
95.25mm	0.030"	1	C5859-040	\$135.07

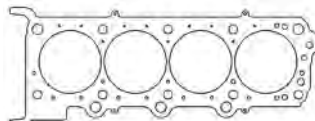



Cometic Gasket - An Exclusive NASCAR Performance Product

FORD

239, 256, 272, 292, 312 Y-Block V8 1956-64

Head Gasket

MLS Head Gasket - Left Side				
Bore	Thickness	Pkg Qty	Part #	List Price
3.860"040"1.....	C15170-040	\$100.67

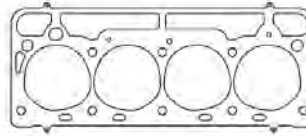

Additional thicknesses available see page 4

MLS Head Gasket - Right Side				
Bore	Thickness	Pkg Qty	Part #	List Price
3.860"040"1.....	C15171-040	\$100.67

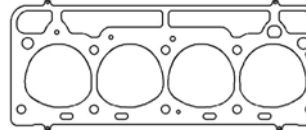

Individual Gaskets

Exhaust Gasket Set		
Application	Part #	List Price
Y-Block 1956-64	C15082-064	\$31.68

Oil Pan Gasket		
Application	Part #	List Price
Y-Block 1956-64	C15084	\$23.30

Intake Gasket Set		
Application	Part #	List Price
Y-Block 1956-64	C15083	\$34.87

Timing Cover Gasket		
Application	Part #	List Price
Y-Block 1956-64	C15085	\$13.73

Valve Cover Gasket (sold individually)		
Application	Part #	List Price
Y-Block 1956-64	C15086	\$25.74

Water Pump O-Ring		
Application	Part #	List Price
Y-Block 1956-64	C15087	\$16.33

Gasket Kits



To purchase a complete gasket kit order both top end and bottom end gasket kit

TOP END GASKET KIT

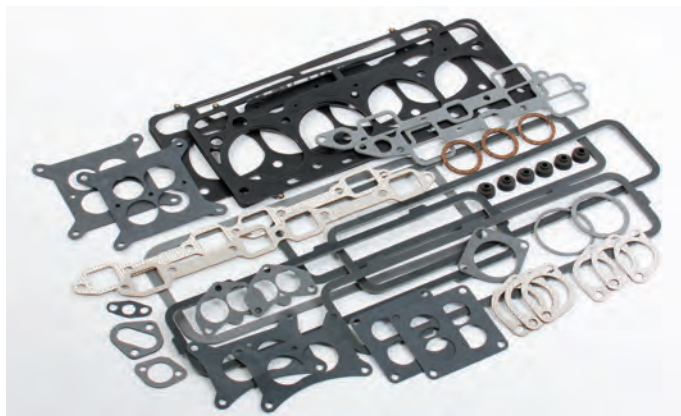

Application	Part #	List Price
239-312 Y-Block 1956-64 3.860" Bore	PRO1039T	\$273.97

BOTTOM END GASKET KIT

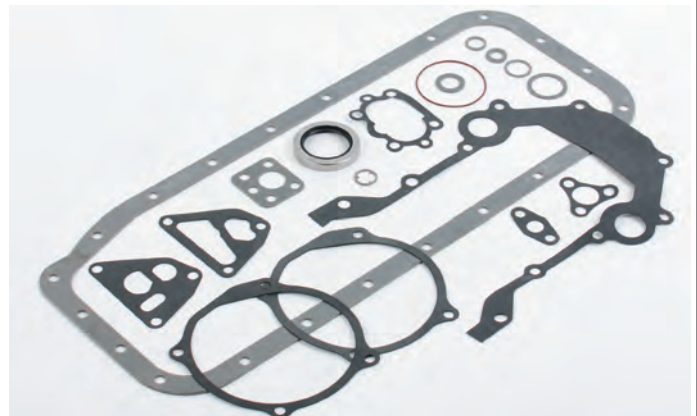

Application	Part #	List Price
239-312 Y-Block 1956-64	PRO1039B	\$138.85



Cometic Gasket - An Exclusive NASCAR Performance Product

FORD

Windsor Small Block V8 SVO & non-SVO 1962-00

Head Gaskets

MLS Head Gaskets - SVO Round Bore

Bore	Thickness	Pkg Qty	Part #	List Price
4.030"	.040"	1	C5478-040	\$89.49
4.060"	.040"	1	C5479-040	\$89.49
4.080"	.040"	1	C5480-040	\$89.49
4.100"	.040"	1	C5481-040	\$89.49
4.155"	.040"	1	C5483-040	\$89.49
4.195"	.051"	1	C5509-051	\$89.49
4.200"	.040"	1	C5485-040	\$89.49

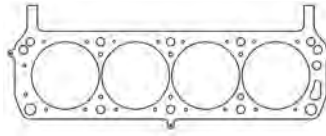

Additional thicknesses available
see page 4

NEW!

MLX Head Gasket - SVO Round Bore

Bore	Thickness	Pkg Qty	Part #	List Price
4.100"	.040"	1	C15372-040	\$115.07
4.200"	.040"	1	C5757-040	\$115.07

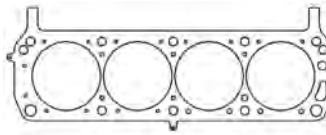

MLS Head Gaskets - non SVO Round Bore

Bore	Thickness	Pkg Qty	Part #	List Price
4.030"	.040"	1	C5511-040	\$89.49
4.060"	.040"	1	C5512-040	\$89.49
4.080"	.040"	1	C5513-040	\$89.49
4.100"	.040"	1	C5514-040	\$89.49
4.155"	.040"	1	C5515-040	\$89.49
4.200"	.040"	1	C5517-040	\$89.49

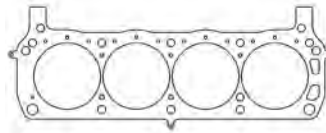

NEW!

MLX Head Gasket - non-SVO Round Bore

Bore	Thickness	Pkg Qty	Part #	List Price
4.100"	.040"	1	C15371-040	\$115.07
4.200"	.040"	1	C5025-040	\$115.07

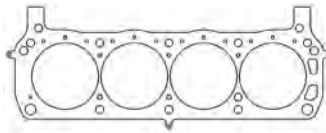

NEW!

Copper Head Gaskets

Bore	Thickness	Pkg Qty	Part #	List Price
4.000"	.043"	1	C15420-043	\$109.13

Individual Gaskets

Valve Cover Gasket (sold individually)

Application	Part #	List Price
289/302/351-Molded Rubber	C5974	\$16.98
SVO, M6049 Heads .094" KF	C5659-094	\$12.28

Timing Cover Sets

Application	Part #	List Price
260/289/302/351W 1962-78	C5064	\$24.92
302/351W 1979-97	C5065	\$24.92

Intake Manifold Gaskets

Application	Part #	List Price
N351 2.120" x 1.280"	C5652-060	\$26.99
M6049 Yates 3C 2.00" x 1.35"	C5268-047	\$26.17
China Rail Gaskets	C5653-060	\$4.49

Oil Pan Gasket Sets

Application	Part #	List Price
289/302 4pc Kit	C15091	\$33.15
351W 4pc Kit	C5279-094	\$33.15
351W 4pc Kit - For Stokers	C15092	\$33.15

Exhaust Manifold Gaskets

Application	Part #	List Price
N351 1.585" x 1.681" .064" AM	C5655-064	\$24.54
351W 1.52" x 1.57" MLS	C15176-030	\$41.04
289/302 1.120" x 1.480" MLS	C5898-030	\$41.04
289/302 1.127" x 1.750" MLS	C5899-030	\$41.04
Yates 1.725" x 1.890" .064" AM	C5357-064	\$35.63
Yates MLS Ind Ports (8 pcs)	C5665-040	\$38.55

Rear Main Seals

Application	Part #	List Price
289/302 Viton 2pc 1968-82	C5688	\$28.22
351W Viton 2pc 1969-83	C5689	\$29.91
289/302 1pc 1983-01	C5189	\$17.78
351W 1pc 1983-01	C15090	\$15.98
351W w/302 Crank	C5384	\$97.85

See page 55 for additional gaskets



Cometic Gasket - An Exclusive NASCAR Performance Product

FORD

Windsor Small Block V8 SVO & non-SVO 1965-00

Individual Gaskets

Carb/Throttle Body Gaskets		
Application	Part #	List Price
Holley 4bbl Open Plenum Carb.....	C5263	\$5.73
5.0L 1986-93 TB Gasket.....	C15099	\$6.08
5.0/5.8L 85-97 Truck TB Gasket.....	C15100	\$3.40
3.8/5.0L 89-95 TB Gasket.....	C15101	\$3.40

Water Pump Gaskets		
Application	Part #	List Price
289/302/351W 67-91 WP Gasket	C5662-060	\$8.97
302/351W 69-85 Cover Plate	C5353	\$9.79
289/302 63-65.5 Plate to Block	C15093	\$10.46
289/302/351W 63-69 Pump to Plate	C15094	\$10.46
351W 80-87 Water Pump Plate.....	C15095	\$8.62
302/351W 86-97 Pump to Plate	C15096	\$8.62
351W 88-95 Pump to Block.....	C15097	\$8.62
302 91-01 Plate to Block Gsk.....	C15098	\$8.62

Fuel Pump Gasket		
Application	Part #	List Price
Small Block Ford	C5389-060	\$1.79

Gasket Kits



To purchase a complete gasket kit order both top end and bottom end gasket kit

TOP END GASKET KITS

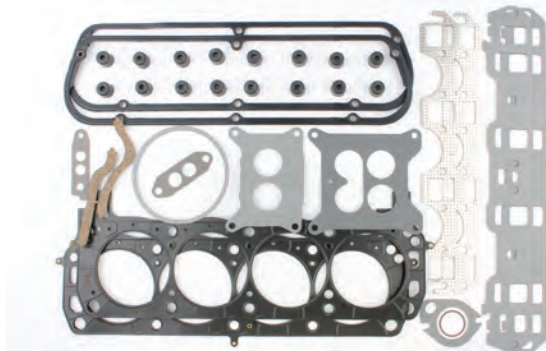

Application	Part #	List Price
289ci 65-68 & 302ci 68-85 4.100" Bore.....	PRO1015T	\$236.89
302ci EFI 86-95 4.100" Bore	PRO1016T	\$278.09
351ci Windsor 69-87 4.100" Bore.....	PRO1013T	\$278.09
351ci Windsor EFI 88-95 4.100" Bore	PRO1014T	\$273.97

BOTTOM END GASKET KITS

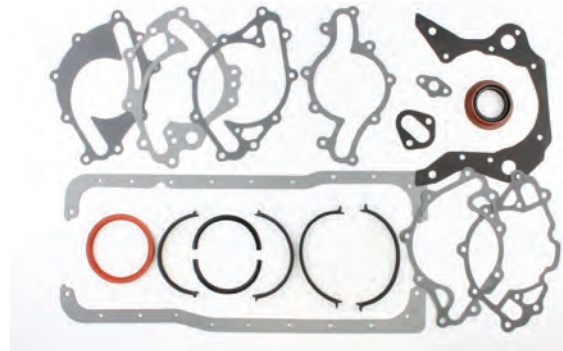

Application	Part #	List Price
289/302ci 65-95.....	PRO1015B	\$77.14
351ci Windsor 69-95.....	PRO1013B	\$110.20

Small Block Ford V8 - Aftermarket & Race

Head Gaskets

MLS Head Gaskets-SVO Yates w/Valve Pockets-LHS				
Bore	Thickness	Pkg Qty	Part #	List Price
4.100"	.040"	1	C5358-040	\$89.49
4.180"	.040"	1	C5364-040	\$89.49
4.200"	.040"	1	C5366-040	\$89.49

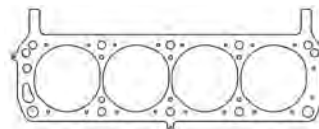

Additional thicknesses available see page 4

MLS Head Gaskets-SVO Yates w/Valve Pockets-RHS				
Bore	Thickness	Pkg Qty	Part #	List Price
4.100"	.040"	1	C5359-040	\$89.49
4.180"	.040"	1	C5365-040	\$89.49
4.200"	.040"	1	C5367-040	\$89.49

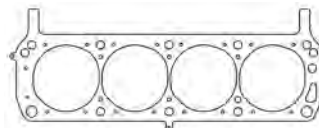

See page 56 for additional gaskets



Cometic Gasket - An Exclusive NASCAR Performance Product

FORD

Small Block Ford V8 - Aftermarket & Race

Head Gaskets

MLS Head Gaskets - Brodix Track 1, Edelbrock RPM Performer, AFR Heads w/Coolant Channels

Bore	Thickness	Pkg Qty	Part #	List Price
4.030"	.040"	1	C5909-040	\$98.23
4.080"	.040"	1	C5910-040	\$98.23
4.100"	.040"	1	C5911-040	\$98.23
4.155"	.040"	1	C5912-040	\$98.23
4.200"	.040"	1	C5913-040	\$98.23

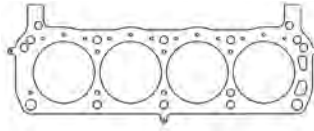

Additional thicknesses available see page 4

MLS Head Gaskets - New Boss 302 Blocks (will not work with OEM non-SVO heads)

Bore	Thickness	Pkg Qty	Part #	List Price
4.030"	.040"	1	C5958-040	\$89.49
4.080"	.040"	1	C5959-040	\$89.49
4.100"	.040"	1	C5960-040	\$89.49
4.155"	.040"	1	C5961-040	\$89.49
4.200"	.040"	1	C5962-040	\$89.49

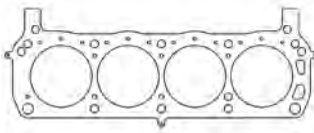

NEW!

MLX Head Gasket - New Boss 302 Blocks

Bore	Thickness	Pkg Qty	Part #	List Price
4.200"	.040"	1	C15373-040	\$115.07

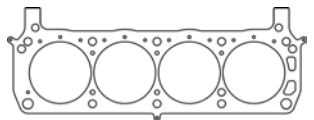

MLS Head Gasket - World Products Man-o-War 10 Degree Heads-6 Bolts per Cylinder

Bore	Thickness	Pkg Qty	Part #	List Price
4.080"	.040"	1	C5132-040	\$98.23
4.100"	.040"	1	C5133-040	\$98.23
4.155"	.040"	1	C5134-040	\$98.23
4.180"	.040"	1	C5135-040	\$98.23

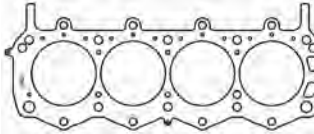

MLS Head Gasket-Brodix ASCS Head/R452 Block

Bore	Thickness	Pkg Qty	Part #	List Price
4.125"	.040"	1	C5217-040	\$89.49

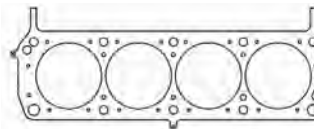

351 Cleveland, 351 Modified, & 400ci V8

Head Gasket

MLS Head Gasket

Bore	Thickness	Pkg Qty	Part #	List Price
4.100"	.040"	1	C5871-040	\$89.49

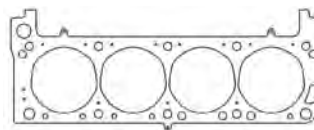

Additional thicknesses available see page 4

Individual Gaskets

Valve Cover Gasket (sold individually)

Application	Part #	List Price
351C/351M/400 .125" KF	C5659-125	\$24.54

Oil Pan Gasket Set

Application	Part #	List Price
351C/351M/400 1970-81	C5278-094	\$33.15

Intake Manifold Gaskets

Application	Part #	List Price
351C/351M/400 4bbl Heads	C15102	\$34.51
351C/351M/400 2bbl Heads	C15103	\$34.51

Water Pump Gaskets

Application	Part #	List Price
Backing Plate Gasket	C5353	\$9.79
Water Pump Gasket w/Cast Iron Pump	C5662-060	\$8.97



Cometic Gasket - An Exclusive NASCAR Performance Product

FORD

351 Cleveland, 351 Modified, & 400ci V8

Individual Gaskets

Exhaust Manifold Gasket		
Application	Part #	List Price
351C/351M/400 4bbl Heads.....	C15104	\$35.69

Timing Cover Set		
Application	Part #	List Price
351C/351M/400 1970-81.....	C5066	\$22.65

Fuel Pump Gasket		
Application	Part #	List Price
351C/351M/400 .031" Fiber.....	C15105	\$2.27

Rear Main Seals		
Application	Part #	List Price
351C/351M/400 - 2pc Poly.....	C5088	\$9.48
351C/351M/400 - 2pc Viton.....	C5689	\$29.91

Ford RY45 V8

Head Gaskets

MLX Head Gaskets - Right Side				
Bore	Thickness	Pkg Qty	Part #	List Price
4.290"040"1.....	C15338-040	\$115.84

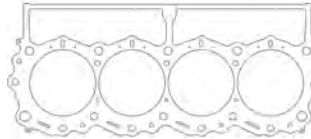

Additional thicknesses available see page 4

MLX Head Gaskets - Left Side				
Bore	Thickness	Pkg Qty	Part #	List Price
4.290"040"1.....	C15337-040	\$115.84

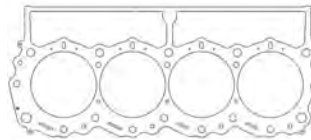

Ford FR9 Race V8

Head Gaskets

MLX Head Gaskets - Right Side				
Bore	Thickness	Pkg Qty	Part #	List Price
4.190"040"1.....	C5587-040	\$115.84

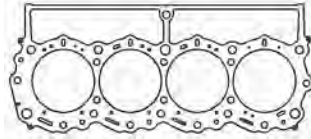

Additional thicknesses available see page 4

MLX Head Gaskets - Left Side				
Bore	Thickness	Pkg Qty	Part #	List Price
4.190"040"1.....	C5588-040	\$115.84

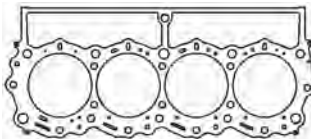

Individual Gaskets

Intake Manifold Gaskets		
Application	Part #	List Price
FR9 V8 - 2.05" x 1.39" .060" KF.....	C15106-060	\$33.19

Exhaust Manifold Gaskets		
Application	Part #	List Price
FR9 V8 - .030" MLS.....	C15107-030	\$58.38

Ford Flathead V8 1932-53

Head Gaskets

MLS Head Gasket - 1932-38 21 Bolt				
Bore	Thickness	Pkg Qty	Part #	List Price
3.156"040"1.....	C5870-040	\$146.53

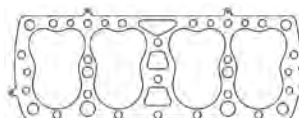

Additional thicknesses available see page 4

See page 58 for additional gaskets



Cometic Gasket - An Exclusive NASCAR Performance Product

FORD

Ford Flathead V8 1932-53

Head Gaskets

MLS Head Gasket - 1938-48 24 Bolt

Bore	Thickness	Pkg Qty	Part #	List Price
3.250"	.051"	1	C5908-051	\$146.53
3.375"	.051"	1	C5108-051	\$146.53

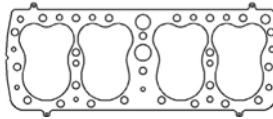

Additional thicknesses available see page 4

NEW!

MLS Head Gasket - 1949-53 24 Bolt - RHS

Bore	Thickness	Pkg Qty	Part #	List Price
3.375"	.051"	1	C15088-051	\$146.53
3.375"	.092"	1	C15088-092	\$190.42

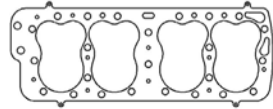

NEW!

MLS Head Gasket - 1949-53 24 Bolt - LHS

Bore	Thickness	Pkg Qty	Part #	List Price
3.375"	.051"	1	C15089-051	\$146.53
3.375"	.092"	1	C15089-092	\$190.42

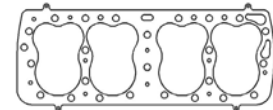

Individual Gaskets

Carburetor Gaskets (sold individually)

Application	Part #	List Price
Holley Air Cleaner Gasket	C15108	\$2.97
59A, 8BA, 8CM 2bbl Gasket	C15109	\$3.38

Timing Cover Gaskets

Application	Part #	List Price
59A 1945-48 .015" Fiber	C15134	\$6.23
8BA/8CM 1948-53 .015" Fiber	C15135	\$6.23

Intake Manifold Gaskets

Application	Part #	List Price
59A 1945-48 .060" KF	C15120	\$34.44
8BA/8CM 1948-53 .060" KF	C15121	\$34.44

Water Pump Gaskets

Application	Part #	List Price
59A 1945-48 .015" Fiber	C15136	\$4.94
8BA/8CM 1948-53 .015" Fiber	C15137	\$6.23

Exhaust Manifold Gaskets

Application	Part #	List Price
59A, 8BA, 8CM 1945-53 8PK	C15116	\$41.59

Fuel Pump Gaskets

Application	Part #	List Price
59A 45-48 Fuel Pump Stand	C15117	\$1.82
59A 46-53 Fuel Pump Cover	C15118	\$1.30
8BA/8CM 48-53 Fuel Pump Mount	C15119	\$1.30

Distributor Gaskets

Application	Part #	List Price
59A 45-48 Distributor Base	C15110	\$3.90
59A 45-48 Distributor Cap Cover	C15111	\$2.86
59A Distributor Terminal Housing	C15112	\$2.61
59A 32-41 Distributor Base	C15113	\$3.90
59A 32-41 Distributor Cap Cover	C15114	\$2.61
59A Distributor Coil Base	C15115	\$2.86

Oil Pump/Pan Gaskets

Application	Part #	List Price
59A 32-41 Oil Pump Drive Cover	C15122	\$3.65
59A 45-48 Oil Pump Drive Cover	C15123	\$3.65
59A 45-48 Oil Pump Mounting	C15126	\$1.04
59A 45-48 Oil Pump Screen Cover	C15127	\$1.04
8BA/8CM 48-53 Oil Pump Drive Cover	C15130	\$4.16
8BA/8CM 48-53 Oil Pump Relief Nut	C15132	\$1.04
59A 45-48 Drain Plug Gasket	C15124	\$1.57
59A 1938 Drain Plug Gasket	C15125	\$1.04
8BA/8CM 48-53 Drain Plug Gasket	C15133	\$1.04
8BA/8CM Oil Pan Clean Out	C15128	\$6.49
8BA/8CM Oil Pan Gasket	C15129	\$16.63
8BA/8CM Dipstick Tube Gasket	C15131	\$1.30

352, 390, 406, 410, 427, & 428 FE V8

Head Gaskets

MLS Head Gaskets - Top Oiler

Bore	Thickness	Pkg Qty	Part #	List Price
4.080"	.040"	1	C5833-040	\$100.67
4.165"	.040"	1	C5834-040	\$100.67
4.250"	.040"	1	C5835-040	\$100.67
4.300"	.040"	1	C5523-040	\$100.67
4.400"	.040"	1	C5840-040	\$100.67

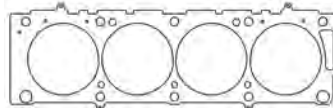

Additional thicknesses available see page 4



Cometic Gasket - An Exclusive NASCAR Performance Product

FORD

352, 390, 406, 410, 427, & 428 FE V8

Head Gaskets

MLS Head Gasket - SOHC Side Oiler				
Bore	Thickness	Pkg Qty	Part #	List Price
4.400"	.040"	1	C5841-040	\$100.67

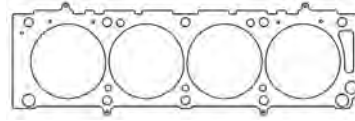

Additional thicknesses available see page 4

Individual Gaskets

Valve Cover Gaskets (sold individually)		
Application	Part #	List Price
All FE & 428CJ/SCJ	C5138-188	\$22.54
427 SOHC LHS	C15138-188	\$23.74
427 SOHC RHS	C15139-188	\$23.74

Timing Cover Sets		
Application	Part #	List Price
352/360 1958-60	C5067	\$22.65
332-428 1961-71	C5068	\$22.65

Intake Manifold Gaskets		
Application	Part #	List Price
STD/Low Riser 428CJ/SCJ	C5137-060	\$30.81
427 SOHC	C15140-060	\$33.97

Oil Pan Gasket		
Application	Part #	List Price
FE V8 1961-71	C5141-125	\$23.30

Exhaust Manifold Gaskets		
Application	Part #	List Price
352-410 FE & 428CJ/SCJ MLS	C5922-030	\$47.60
427 SOHC .064" AM	C15141-064	\$24.54

Rear Main Seal		
Application	Part #	List Price
FE V8 1961-71	C5142	\$25.63

Water Pump Gaskets		
Application	Part #	List Price
FE V8 1961-71 (Pair)	C5140-031	\$3.97

Gasket Kits



To purchase a complete gasket kit order both top end and bottom end gasket kit

TOP END GASKET KIT

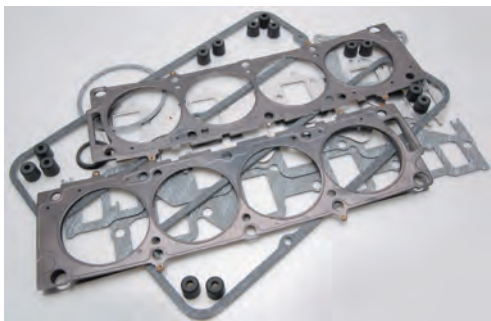

Application	Part #	List Price
352, 390, 410, 428 FE V8 4.300" Bore	PRO1027T	\$181.27

BOTTOM END GASKET KIT



Application	Part #	List Price
352, 390, 410, 428 FE V8	PRO1027B	\$61.71



Cometic Gasket - An Exclusive NASCAR Performance Product

FORD

429ci 7.0L & 460ci 7.5L Big Block V8

Head Gaskets

MLS Head Gaskets

Bore	Thickness	Pkg Qty	Part #	List Price
4.400"	.040"	1	C5666-040	\$98.23
4.440"	.060"	1	C15400-040	\$98.23
4.500"	.040"	1	C5667-040	\$98.23
4.600"	.040"	1	C15142-040	\$98.23
4.670"	.040"	1	C5668-040	\$98.23

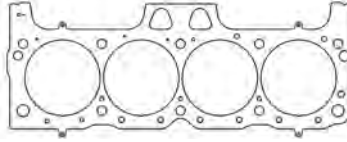

Additional thicknesses available see page 4

NEW!

Copper Head Gaskets

Bore	Thickness	Pkg Qty	Part #	List Price
4.520"	.043"	1	C15421-043	\$125.30

Individual Gaskets

Valve Cover Gaskets (sold individually)

Application	Part #	List Price
429/460 Big Block .125" KF	C5205-125	\$20.86

Timing Cover Set

Application	Part #	List Price
429/460 1968-85	C5069	\$22.65

Intake Manifold Gaskets

Application	Part #	List Price
Stock 429/460 Heads	C5043-060	\$33.97
CJ/SCJ 2.24" x 2.60" Port	C5206-060	\$32.34

Oil Pan Gasket

Application	Part #	List Price
429/460 4 pc set	C5125-094	\$39.47

Exhaust Manifold Gaskets

Application	Part #	List Price
429/460 Oval Port - .030" MLS	C5900-030	\$45.36

Rear Main Seal

Application	Part #	List Price
429/460 Big Block 2pc	C5208	\$15.99

Water Pump Gaskets

Application	Part #	List Price
429/460 Big Block	C5209-031	\$12.74

Gasket Kits



To purchase a complete gasket kit order both top end and bottom end gasket kit

TOP END GASKET KIT

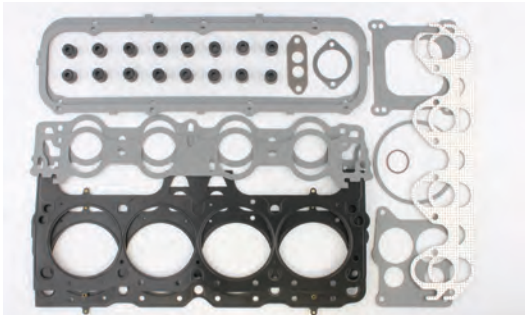

Application	Part #	List Price
429/460ci Big Block V8 68-78 4.500" Bore	PRO1012T	\$232.77

BOTTOM END GASKET KIT

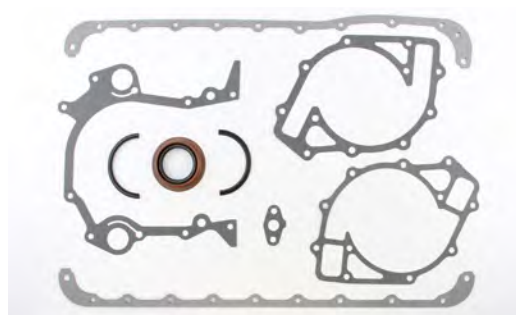

Application	Part #	List Price
429/460ci Big Block V8 68-78	PRO1012B	\$67.22



Cometic Gasket - An Exclusive NASCAR Performance Product

FORD

Prostock Racing V8

Head Gaskets

MLS Head Gaskets - D/E460 PROSTOCK				
Bore	Thickness	Pkg Qty	Part #	List Price
4.600"	.045"	1	C5731-045	\$130.14
4.685"	.045"	1	C5732-045	\$130.14

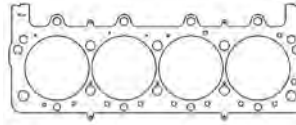

Additional thicknesses available see page 4

MLS Head Gaskets - A460/C460 PROSTOCK				
Bore	Thickness	Pkg Qty	Part #	List Price
4.400"	.045"	1	C5745-045	\$130.14
4.600"	.045"	1	C5743-045	\$130.14
4.685"	.045"	1	C5744-045	\$130.14

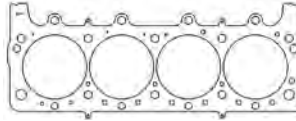

MLS Head Gaskets- A500 PROSTOCK - LHS				
Bore	Thickness	Pkg Qty	Part #	List Price
4.600"	.045"	1	C5727-045	\$130.14
4.685"	.045"	1	C5729-045	\$130.14

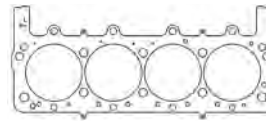

MLS Head Gaskets - A500 PROSTOCK - RHS				
Bore	Thickness	Pkg Qty	Part #	List Price
4.600"	.045"	1	C5728-045	\$130.14
4.685"	.045"	1	C5730-045	\$130.14

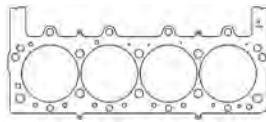

MLS Head Gasket - 460 w/Hemi 14 Bolt Head				
Bore	Thickness	Pkg Qty	Part #	List Price
4.700"	.040"	1	C5888-040	\$130.14

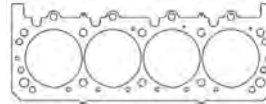

MLS Head Gasket - JC50 500ci PROSTOCK - LHS				
Bore	Thickness	Pkg Qty	Part #	List Price
4.735"	.052"	1	C5284-052	\$161.17

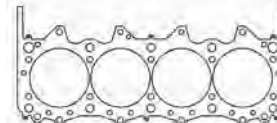

MLS Head Gasket - JC50 500ci PROSTOCK - RHS				
Bore	Thickness	Pkg Qty	Part #	List Price
4.735"	.052"	1	C5285-052	\$161.17

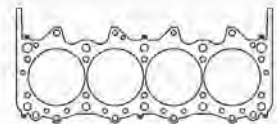

MLS Head Gaskets - 800ci W/5.0" Bore Centers				
Bore	Thickness	Pkg Qty	Part #	List Price
4.770"	.040"	1	C5875-040	\$98.23
4.770"	.040"	1	C5875-051	\$98.23

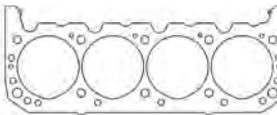

Individual Gaskets

Exhaust Manifold Gaskets			
Application	Part #	List Price	
JC50 500ci - .030" MLS	C5257-030	\$58.38	

6.0L Powerstroke Diesel 2003-08

Head Gaskets

MLX Head Gasket - 2003-06 18mm Dowels				
Bore	Thickness	Pkg Qty	Part #	List Price
96mm	.062"	1	C5589-062	\$152.30

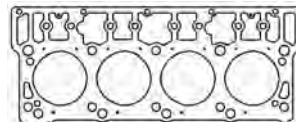

Additional thicknesses available see page 4



Cometic Gasket - An Exclusive NASCAR Performance Product

FORD

6.0L Powerstroke Diesel 2003-08

Head Gaskets

MLX Head Gasket - 2007-08 20mm Dowels

Bore	Thickness	Pkg Qty	Part #	List Price
96mm062"1	C5984-062\$152.30

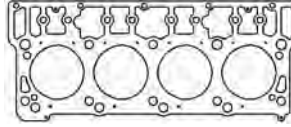

Additional thicknesses available see page 4

Individual Gaskets

Valve Cover Gasket Set

Application	Part #	List Price
6.0L Powerstroke 03-08	C15143\$22.65

HPOP Cover Gasket

Application	Part #	List Price
6.0L Powerstroke 03-07	C15145\$26.97

Intake Manifold Gasket Set

Application	Part #	List Price
6.0L Powerstroke 03-08	C15144\$104.16

Oil Cooler O-Ring Kit

Application	Part #	List Price
6.0L Powerstroke 03-07	C15146\$127.58

Exhaust Manifold Gasket

Application	Part #	List Price
6.0L Powerstroke 03-08 - MLS	C5089-030\$49.74

Cylinder Head Dowels (sold individually)

Application	Part #	List Price
6.0L Powerstroke 03-06 18mm	C15147\$3.91
6.0L Powerstroke 07-08 20mm	C15148\$7.66

Valve Stem Seals (sold individually)

Application	Part #	List Price
6.0L Powerstroke 03-08 (Req 32)	3217V\$4.10

Gasket Kits



To purchase a complete gasket kit order both top end and bottom end gasket kit

TOP END GASKET KITS

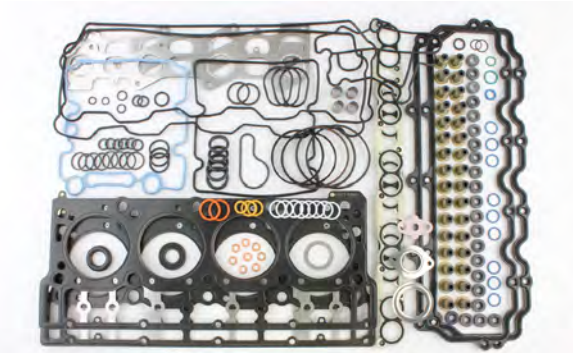

Application	Part #	List Price
6.0L Powerstroke 03-06 96mm Bore	PRO3005T\$788.35
6.0L Powerstroke 07-08 96mm Bore	PRO3006T\$788.35

BOTTOM END GASKET KIT

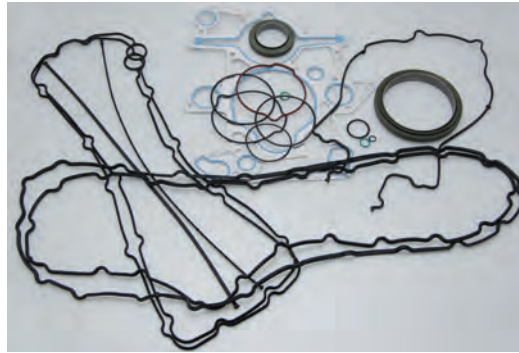

Application	Part #	List Price
6.0L Powerstroke 03-08	PRO3005B\$146.70



Cometic Gasket - An Exclusive NASCAR Performance Product

FORD

6.4L Powerstroke Diesel 2008-10

Head Gasket

MLX Head Gasket				
Bore	Thickness	Pkg Qty	Part #	List Price
103mm062"1	C5610-062	\$152.30

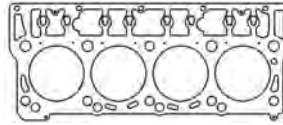

Additional thicknesses available see page 4

MLX Head Gasket - REV B				
Bore	Thickness	Pkg Qty	Part #	List Price
103mm062"1	C15175-062	\$152.30

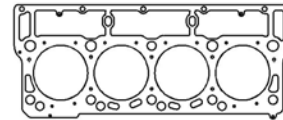

Individual Gaskets

Valve Cover Gasket Set		
Application	Part #	List Price
6.4L Powerstroke 08-10	C15151	\$33.98

Turbo Mounting Kit		
Application	Part #	List Price
6.4L Powerstroke 08-10	C15154	\$73.63

Intake Manifold Gasket Set		
Application	Part #	List Price
6.4L Powerstroke 08-10	C15152	\$36.98

Fuel Injector Seal Kit		
Application	Part #	List Price
6.4L Powerstroke 08-10 (does 8)	C15155	\$23.92

Exhaust Manifold Gasket		
Application	Part #	List Price
6.4L Powerstroke 08-10 - MLS	C5089-030	\$49.74

Oil Cooler O-Ring Kit		
Application	Part #	List Price
6.4L Powerstroke 08-10	C15156	\$63.10

Valve Stem Seals (sold individually)		
Application	Part #	List Price
6.4L Powerstroke 08-10 (Req 32)	3217V	\$4.10

Cooling/Water Pump Gaskets		
Application	Part #	List Price
Thermostat Housing Seal	C15157	\$5.74
Lower Coolant Hose Gasket	C15158	\$6.49
Upper Coolant hose Gasket	C15159	\$5.95

Gasket Kits



To purchase a complete gasket kit order both top end and bottom end gasket kit

TOP END GASKET KIT

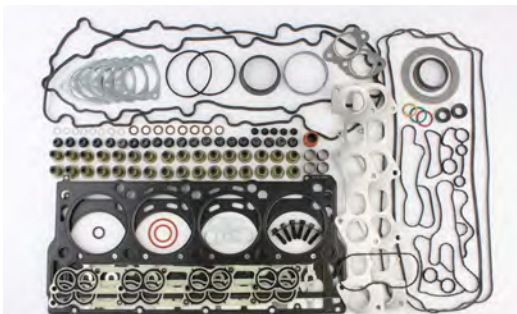

Application	Part #	List Price
6.4L Powerstroke 08-10 103mm Bore	PRO3007T	\$788.35

BOTTOM END GASKET KIT

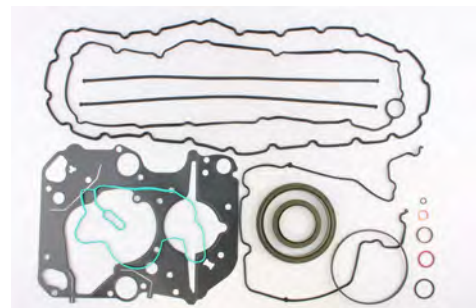

Application	Part #	List Price
6.4L Powerstroke 08-10	PRO3007B	\$192.76



Cometic Gasket - An Exclusive NASCAR Performance Product

FORD

6.7L Scorpion Diesel 2011-Up

Head Gaskets

MLX Head Gasket - RHS

Bore	Thickness	Pkg Qty	Part #	List Price
100mm	.053"	1	C15160-053	\$152.30

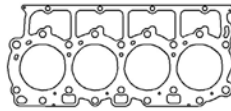

Additional thicknesses available see page 4

MLX Head Gasket - LHS

Bore	Thickness	Pkg Qty	Part #	List Price
100mm	.053"	1	C15161-053	\$152.30

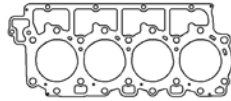

7.3L Powerstroke Diesel 1994-03

Head Gasket

MLS Head Gasket

Bore	Thickness	Pkg Qty	Part #	List Price
4.140"	.066"	1	C5839-066	\$152.30

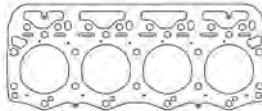

Additional thicknesses available see page 4

NEW!

MLX Head Gasket

Bore	Thickness	Pkg Qty	Part #	List Price
4.140"	.067"	1	C15390-067	\$152.30

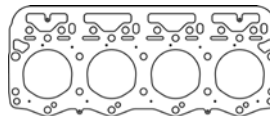

Individual Gaskets

Valve Cover Gaskets (sold individually)

Application	Part #	List Price
7.3L Powerstroke 94-97	C15162	\$56.64
7.3L Powerstroke 98-03	C15163	\$79.30

HPOP Gaskets

Application	Part #	List Price
7.3L Powerstroke 94-95	C15164	\$18.14
7.3L Powerstroke 96-03	C15165	\$18.14

Intake Manifold Gasket Set

Application	Part #	List Price
7.3L Powerstroke .060" AFM	C5090-060	\$29.53

Valve Stem Seals (sold individually)

Application	Part #	List Price
7.3L Powerstroke (need 16)	3216V	\$3.76

Exhaust Manifold Gaskets

Application	Part #	List Price
7.3L Powerstroke .064" AM	C5091-064	\$36.86

Gasket Kits



To purchase a complete gasket kit order both top end and bottom end gasket kit

TOP END GASKET KIT

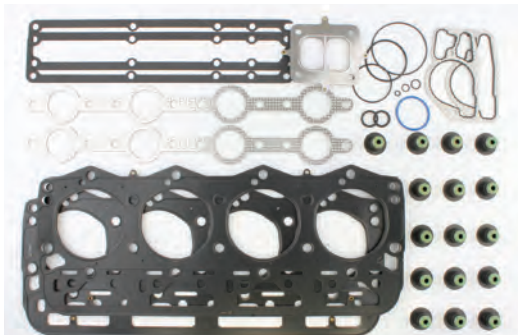

Application	Part #	List Price
7.3L Powerstroke 1994-03 4.140" Bore	PRO3010T	\$450.92

BOTTOM END GASKET KIT



Application	Part #	List Price
7.3L Powerstroke 1994-03	PRO3010B	\$166.13



Cometic Gasket - An Exclusive NASCAR Performance Product

OLDSMOBILE

330, 350, 400, 403, & 455ci V8

Head Gasket

MLS Head Gaskets

Bore	Thickness	Pkg Qty	Part #	List Price
4.125"	.040"	1	C5808-040	\$100.67
4.200"	.040"	1	C5809-040	\$100.67
4.270"	.040"	1	C5811-040	\$100.67
4.400"	.040"	1	C5810-040	\$100.67

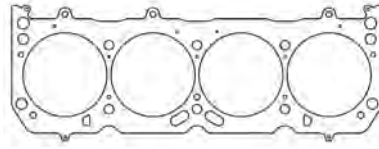

Additional thicknesses available see page 4

Individual Gaskets

Valve Cover Gasket (sold individually)

Application	Part #	List Price
330-455ci Olds V8 .188" ML	C5824-188	\$23.30

Timing Cover Set

Application	Part #	List Price
330-455ci Olds V8 1964-90	C5070	\$22.65

Intake Manifold Gaskets

Application	Part #	List Price
330, 350, & 403 Small V8	C5216-030	\$26.99
400 & 455 Big V8	C5813-060	\$26.99

Water Pump Gaskets

Application	Part #	List Price
330-455ci V8 1968-76 w/AC	C15166	\$8.62
330-455ci V8 1964-90	C15167	\$8.62

Exhaust Manifold Gaskets

Application	Part #	List Price
330-455ci V8 Stock Port .064" AM	C5812-064	\$30.65
330-455ci V8 1.45"x1.92" MLS	C5904-030	\$44.28

Oil Pan Gasket Kit

Application	Part #	List Price
330-455ci Olds V8 4pc Kit	C5822-094	\$31.85

Gasket Kits



To purchase a complete gasket kit order both top end and bottom end gasket kit

TOP END GASKET KIT

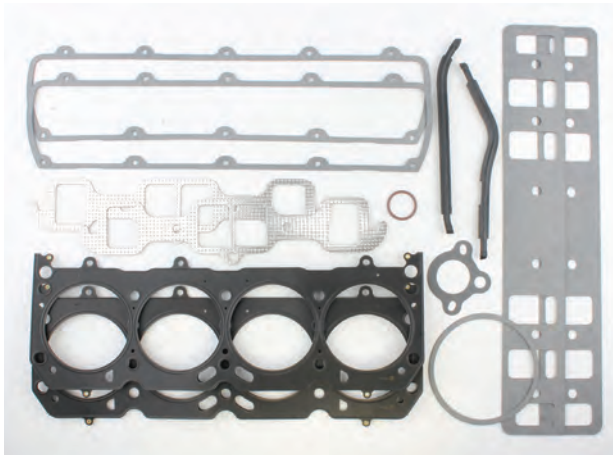

Application	Part #	List Price
Olds 455ci V8 1968-76 4.200" Bore	PRO1009T	\$201.87

BOTTOM END GASKET KIT



Application	Part #	List Price
Olds 455ci V8 1968-76	PRO1009B	\$61.71



Cometic Gasket - An Exclusive NASCAR Performance Product

OLDSMOBILE

371 J-2 Golden Rocket 1957-58

Head Gasket

MLS Head Gasket				
Bore	Thickness	Pkg Qty	Part #	List Price
4.190"	.040"	1	C5129-040	\$100.67

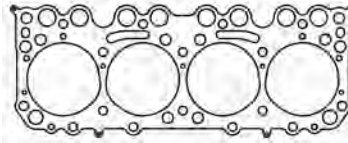

Additional thicknesses available see page 4

Individual Gaskets

Intake Manifold Gaskets		
Application	Part #	List Price
371 J-2 Golden Rocket .060" KF	C5130-060	\$37.41

Exhaust Manifold Gasket Set		
Application	Part #	List Price
371 J-2 Golden Rocket .059" CFM	C5131-059	\$30.34

PONTIAC

389 & 421ci V8

Head Gaskets

NEW!

MLS Head Gaskets-389 (63-67) & 421 (63-66)				
Bore	Thickness	Pkg Qty	Part #	List Price
4.300"	.040"	1	C15262-040	\$100.67
4.300"	.060"	1	C15262-060	\$136.90
4.300"	.080"	1	C15262-080	\$147.97

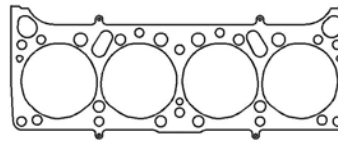

Additional thicknesses available see page 4

326, 350, 400, 428, & 455ci V8

Head Gaskets

MLS Head Gaskets-326 (63-67) & 350 (68-77)				
Bore	Thickness	Pkg Qty	Part #	List Price
3.750"	.040"	1	C5767-040	\$100.67
3.950"	.040"	1	C5710-040	\$100.67

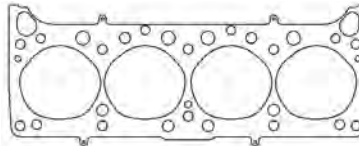

Additional thicknesses available see page 4

MLS Head Gaskets-400 (68-79), 428 (68-69), 455 (70-76)				
Bore	Thickness	Pkg Qty	Part #	List Price
4.160"	.040"	1	C5711-040	\$100.67
4.200"	.040"	1	C5769-040	\$100.67
4.300"	.040"	1	C5712-040	\$100.67
4.380"	.040"	1	C5846-040	\$100.67
4.400"	.040"	1	C5847-040	\$100.67

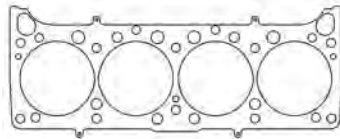

NEW!

Molded Rubber Valve Cover Gaskets (sold individually)		
Application	Part #	List Price
All Models w/Stock Heads	C5044	\$14.72

Timing Cover Set		
Application	Part #	List Price
265-455ci V8 193-81	C5071	\$28.31

Intake Manifold Gaskets		
Application	Part #	List Price
400, 428, & 455ci .060" KF	C5778-060	\$26.99
326-455ci .060" HTS w/o EGR	C15197-060	\$27.05

Oil Pan Gasket Kit		
Application	Part #	List Price
400, 428, & 455ci 4 pc kit	C5176-094	\$19.65

Exhaust Manifold Gaskets		
Application	Part #	List Price
400, 428, & 455ci .064" AM	C5147-064	\$24.53
400, 428, & 455ci D-Port MLS	C5905-030	\$44.28

Water Pump Gasket		
Application	Part #	List Price
400, 428, & 455ci .031" Fiber	C5149-031	\$10.76



Cometic Gasket - An Exclusive NASCAR Performance Product

PONTIAC

326, 350, 400, 428, & 455ci V8

Gasket Kits



To purchase a complete gasket kit order both top end and bottom end gasket kit

TOP END GASKET KIT



Application	Part #	List Price
Big Block 455ci 7.5L 1970-76 4.200" Bore	PRO1010T	\$170.97

BOTTOM END GASKET KIT



Application	Part #	List Price
Big Block 455ci 7.5L 1970-76	PRO1010B	\$44.07

AUSTIN

1000cc 4 Cylinder 1958-65 Healey Sprite Mark I & II

Head Gasket

Copper Head Gasket

Bore	Thickness	Pkg Qty	Part #	List Price
67.5mm043"	1	C4145-043	\$83.32

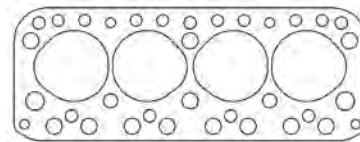

Additional thicknesses available see page 4

1300cc 4 Cylinder Austin Mini

Head Gasket

MLS Head Gasket

Bore	Thickness	Pkg Qty	Part #	List Price
73mm030"	1	C4146-030	\$93.53

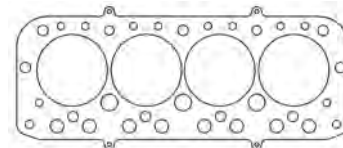

Additional thicknesses available see page 4

BMW

M10 4 Cylinder

Head Gaskets

MLS Head Gasket - 1573/1773cc 1963-77

Bore	Thickness	Pkg Qty	Part #	List Price
86mm051"	1	C4292-051	\$147.33

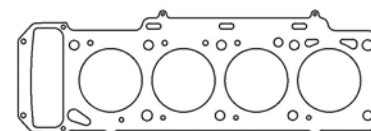

Additional thicknesses available see page 4

See page 68 for additional gaskets



Cometic Gasket - An Exclusive NASCAR Performance Product

BMW

M10 4 Cylinder

Head Gaskets

MLS Head Gasket - 1766/1990cc M10B18/M10B20 1975-88

Bore	Thickness	Pkg Qty	Part #	List Price
90mm	.051"	1	C4293-051	\$147.33

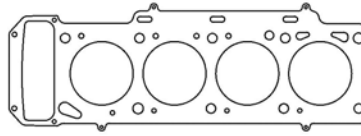

Additional thicknesses available
see page 4

Individual Gaskets

Valve Cover Gasket

Application	Part #	List Price
BMW M10B18/B20 .125" Cork	C4794-125	\$8.82

Oil Pan Gasket Kit

Application	Part #	List Price
BMW M10B18/B20 .062" KF	C4796-062	\$28.93

Intake Manifold Gasket Set

Application	Part #	List Price
BMW M10B18/B20 .060" KF	C4793	\$14.47

Rear Main Seal

Application	Part #	List Price
BMW M10B18/B20	C4797	\$42.56

Exhaust Manifold Gasket Set

Application	Part #	List Price
BMW M10B18/B20 .064" AM	C4883	\$14.11

Thermostat Gasket

Application	Part #	List Price
BMW M10B18/B20 .031" Fiber	C4795-031	\$1.82

Gasket Kits



To purchase a complete gasket kit order both top end and bottom end gasket kit

TOP END GASKET KIT

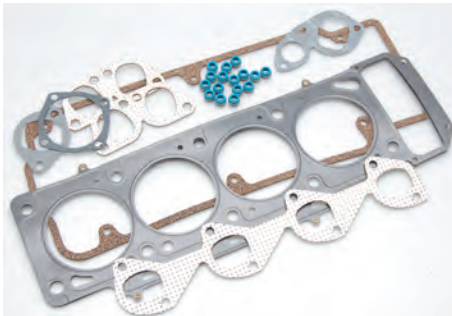

Application	Part #	List Price
M10 1.8/2.0L 1966-88 90mm Bore	PRO2027T	\$213.00

BOTTOM END GASKET KIT



Application	Part #	List Price
M10 1.8/2.0L 1966-88	PRO2027B	\$60.60

M42 1.8L, M44 1.9L 318is 1989-00, 318ti 1992-00, Z3 1996-01

Head Gaskets

MLS Head Gaskets

Bore	Thickness	Pkg Qty	Part #	List Price
85mm	.060"	1	C4348-060	\$178.30
86mm	.060"	1	C4349-060	\$178.30

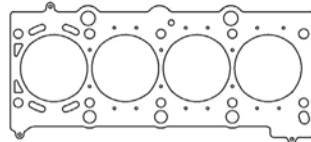

Additional thicknesses available
see page 4



Cometic Gasket - An Exclusive NASCAR Performance Product

BMW

S14B20 1990cc 1986-91, S14B23 2302cc 1986-91 M3 86-91, 320is 1988-91

Head Gaskets

MLS Head Gaskets				
Bore	Thickness	Pkg Qty	Part #	List Price
93.4mm	.051"	1	C4294-051	\$147.33
94.5mm	.051"	1	C4295-051	\$147.33

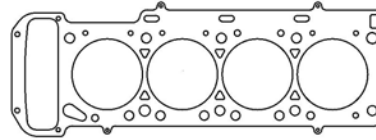

Additional thicknesses available see page 4

M50B20 2.0L 1989-98 320i 1991-95, 520i 1991-95

Head Gasket

MLS Head Gasket				
Bore	Thickness	Pkg Qty	Part #	List Price
82mm	.070"	1	C4332-070	\$237.71

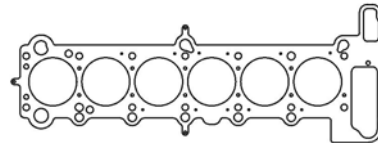

Additional thicknesses available see page 4

M54tuB22 2.2L 1999-Up 320i, 320ci, 520i 00-03, Z3 01-02, Z4 03-Up

Head Gasket

MLS Head Gasket				
Bore	Thickness	Pkg Qty	Part #	List Price
81mm	.030"	1	C4351-030	\$175.38

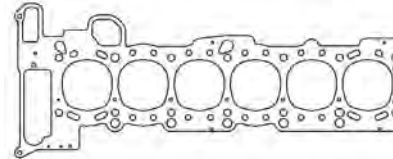

Additional thicknesses available see page 4

M20B20 SOHC 12v 2.0L Inline 6 320 1977-82, 520 1977-81

Head Gasket

MLS Head Gasket				
Bore	Thickness	Pkg Qty	Part #	List Price
81mm	.070"	1	C4393-070	\$237.71

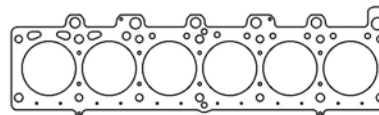

Additional thicknesses available see page 4

M20B25/27 SOHC 12v 2.5/2.7L Inline 6 323i 77-86, Z1 88-93, 525e 83-87, 528e 1981, 325e 83-87

Head Gasket

MLS Head Gasket				
Bore	Thickness	Pkg Qty	Part #	List Price
85mm	.070"	1	C4394-070	\$237.71

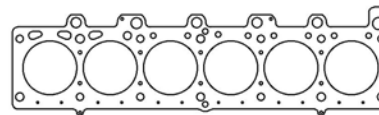

Additional thicknesses available see page 4



Cometic Gasket - An Exclusive NASCAR Performance Product

BMW

M20B25/27 SOHC 12v 2.5/2.7L Inline 6 323i 77-86, Z1 88-93, 525e 83-87, 528e 1981, 325e 83-87

Individual Gaskets

Valve Cover Gasket		
Application	Part #	List Price
BMW M20 2.5/2.7L .059" CFM.....	C4800-059	\$11.79

Oil Pan Gasket		
Application	Part #	List Price
BMW M20 2.5/2.7L.....	C4801-060	\$7.74

Intake Manifold Gasket Set		
Application	Part #	List Price
325e 1984-87 Small Port.....	C4884	\$10.23
325/325is 87-93 Normal Ports.....	C4885	\$13.29

Rear Main Seal		
Application	Part #	List Price
BMW M20 2.5/2.7L.....	C4802	\$21.85

Exhaust Manifold Gasket Set		
Application	Part #	List Price
BMW M20 2.5/2.7L .064" AM	C4798-064	\$14.29

Timing Cover Set		
Application	Part #	List Price
BMW M20 2.5/2.7L.....	C4803	\$11.41

Thermostat Gasket		
Application	Part #	List Price
BMW M20 2.5/2.7L.....	C4799	\$7.53

Water Pump Gasket		
Application	Part #	List Price
BMW M20 2.5/2.7L .020" Fiber	C4804-020	\$2.46

Gasket Kits



To purchase a complete gasket kit order both top end and bottom end gasket kit

TOP END GASKET KIT



Application	Part #	List Price
BMW M20 2.5/2.7L 85mm Bore	PRO2028T	\$267.70

BOTTOM END GASKET KIT



Application	Part #	List Price
M10 1.8/2.0L 1966-88	PRO2027B	\$54.58

M30B25/B28 2.5/2.8L Inline 6, 628Csi 79-81, 525 73-78, 525i 78-81, 525 73-81

Head Gasket

MLS Head Gasket				
Bore	Thickness	Pkg Qty	Part #	List Price
88mm070"	1.....	C4475-070	\$237.51

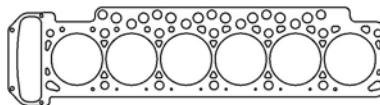

Additional thicknesses available see page 4



Cometic Gasket - An Exclusive NASCAR Performance Product

BMW

M30B30/B32 3.0/3.2L Inline 6 635Csi 76-84, 630Cs 1979, 633Csi 76-79

Head Gasket

MLS Head Gasket				
Bore	Thickness	Pkg Qty	Part #	List Price
90mm070"1	C4476-070	\$237.51

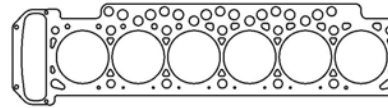

Additional thicknesses available see page 4

S50B30/S52B32 3.0/3.2L Inline 6 (E36) M3 96-99, M Roadster 96-00, M Coupe 96-00 (US Models ONLY)

Head Gasket

MLS Head Gasket				
Bore	Thickness	Pkg Qty	Part #	List Price
87mm070"1	C4329-070	\$237.71

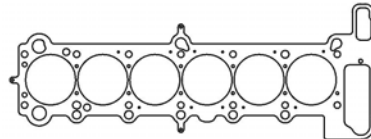

Additional thicknesses available see page 4

S50B30/S52B32 3.0/3.2L Inline 6 (E36) M3 92-00 (Euro Models Only)

Head Gasket

MLS Head Gasket				
Bore	Thickness	Pkg Qty	Part #	List Price
87mm070"1	C4508-070	\$237.71

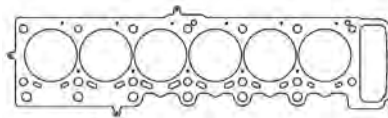

Additional thicknesses available see page 4

N54B30 3.0L Inline 6 (E60) 535i 07-10, (E90/E91/E92/E93) 335i 07-10, (E82/E88) 135i 07-10, X6 08-10, Z4 09-16

Head Gasket

NEW!

MLX Head Gasket				
Bore	Thickness	Pkg Qty	Part #	List Price
85mm044"1	C15257-044	\$188.24

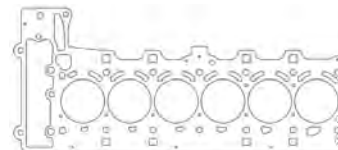

Additional thicknesses available see page 4

S54B32 3.2L Inline 6 M3 (E46) 01-06, Z3 (E36) 01-02, Z4 (E85) 06-Up

Head Gasket

MLS Head Gasket				
Bore	Thickness	Pkg Qty	Part #	List Price
87.5mm070"1	C4505-070	\$210.04

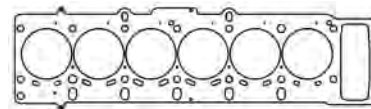

Additional thicknesses available see page 4

M30B34 3.4L Inline 6, 5 Series 85-88, 6 Series 85-87, 7 Series 85-87

Head Gasket

MLS Head Gasket				
Bore	Thickness	Pkg Qty	Part #	List Price
93mm070"1	C4477-070	\$237.51

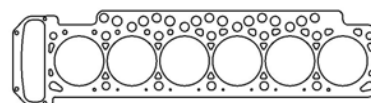

Additional thicknesses available see page 4



Cometic Gasket - An Exclusive NASCAR Performance Product

BMW

M50B25/28 2.5/2.8L Inline 6, 328i 95-00, 528i 95-99, 728i 95-99, Z3 97-99, 325i 91-95, 525i 92-95, 525ix 92-95

Head Gasket

NEW!

MLS Head Gasket

Bore	Thickness	Pkg Qty	Part #	List Price
85mm070"1	C4328-070\$237.71
85mm092"1	C4328-092\$254.37

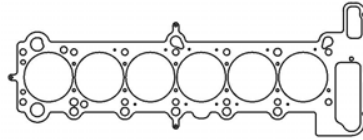

Additional thicknesses available see page 4

M54tuB25/B28 2.5/2.8L & M52B25/M54B30 325i 01-05, 325xi 01-05, 325Ci 01-06, 525i 01-03, Z3 01-06, X5 01-06

Head Gasket

MLS Head Gasket

Bore	Thickness	Pkg Qty	Part #	List Price
85mm030"1	C4352-030\$175.38

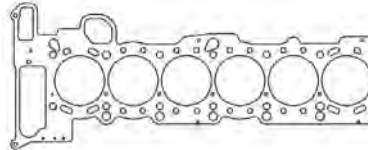

Additional thicknesses available see page 4

S38B35 3.5L Inline 6 M5 84-92, M5i 84-92, M6 84-92

Head Gasket

MLS Head Gasket

Bore	Thickness	Pkg Qty	Part #	List Price
95mm070"1	C4478-070\$237.51

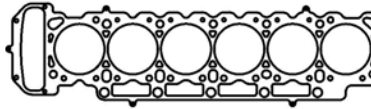

Additional thicknesses available see page 4

S65B40 4.0L V8 M3 (E90, E92, E93) 2007+Up

Head Gaskets

MLS Head Gaskets

Bore	Thickness	Pkg Qty	Part #	List Price
93mm027"1	C5111-027\$140.32
94mm027"1	C5112-027\$140.32

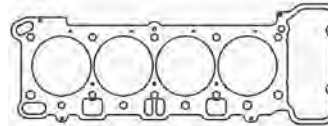

Additional thicknesses available see page 4

N62 4.4L V8 X5 04, 745i 04, 745Ci 04, 545i 04, 645Ci 04

Head Gasket

MLS Head Gasket

Bore	Thickness	Pkg Qty	Part #	List Price
94mm027"1	C4374-027\$147.33

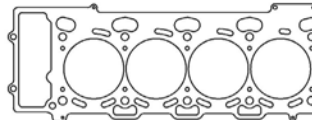

Additional thicknesses available see page 4

S85B50 5.0L V10 M5 05-Up, M6 05-Up

Head Gaskets

NEW!

MLS Head Gaskets

Bore	Thickness	Pkg Qty	Part #	List Price
93mm027"1	C4528-027\$140.32
94.5mm027"1	C4529-027\$140.32
94.5mm051"1	C4529-051\$140.32

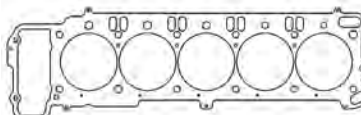

Additional thicknesses available see page 4



Cometic Gasket - An Exclusive NASCAR Performance Product

COVENTRY CLIMAX

FWA SOHC 1.1L 1098cc

Head Gasket

CFM-20 Head Gasket

Bore	Thickness	Pkg Qty	Part #	List Price
74mm	.059"	1	C4301-059	\$85.33

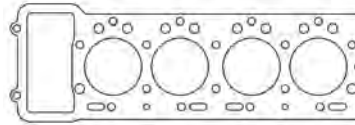

Additional thicknesses available see page 4

FWB/FWE SOHC 1.2L & 1.5L

Head Gasket

CFM-20 Head Gasket

Bore	Thickness	Pkg Qty	Part #	List Price
78mm	.043"	1	C4139-043	\$85.33

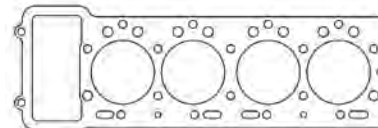

Additional thicknesses available see page 4

FPF DOHC 2.0L

Head Gasket

CFM-20 Head Gasket

Bore	Thickness	Pkg Qty	Part #	List Price
82mm	.059"	1	C4267-059	\$93.59

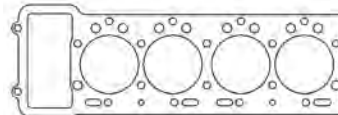

Additional thicknesses available see page 4

FWA/FWB/FWE SOHC 2.0L

Head Gasket

CFM-20 Head Gasket

Bore	Thickness	Pkg Qty	Part #	List Price
80mm	.043"	1	C4229-043	\$85.33

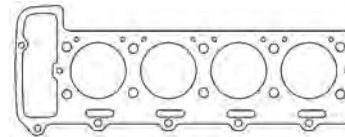

Additional thicknesses available see page 4

FERRARI

308 V8 2v 1974-81

Head Gaskets

MLS Head Gaskets

Bore	Thickness	Pkg Qty	Part #	List Price
81mm	.045"	1	C4430-045	\$147.33
89mm	.045"	1	C4395-045	\$147.33

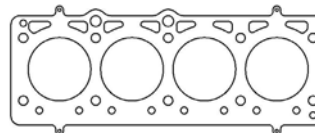

Additional thicknesses available see page 4

308 V8 4v 1982-84

Head Gaskets

MLS Head Gaskets

Bore	Thickness	Pkg Qty	Part #	List Price
83mm	.045"	1	C4428-045	\$147.33
89mm	.045"	1	C4429-045	\$147.33

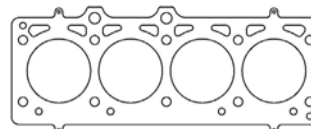

Additional thicknesses available see page 4



Cometic Gasket - An Exclusive NASCAR Performance Product

FERRARI

F40 2.9L Twin Turbo V8 1987-92

Head Gasket

MLS Head Gasket

Bore	Thickness	Pkg Qty	Part #	List Price
84mm060"1	C4482-060\$178.30

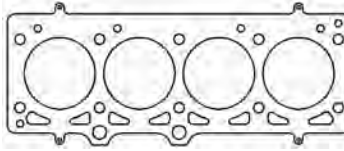

Additional thicknesses available see page 4

FIAT / LANCIA

138.A2 1.5L 1498cc 14 Bolt Head:1986-88 X1/9

Head Gasket

MLS Head Gasket

Bore	Thickness	Pkg Qty	Part #	List Price
88mm044"1	C4952-044\$93.53

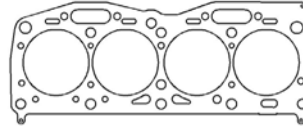

Additional thicknesses available see page 4

D50

Head Gasket

CFM-20 Head Gasket

Bore	Thickness	Pkg Qty	Part #	List Price
79mm059"1	C4131-059\$85.33

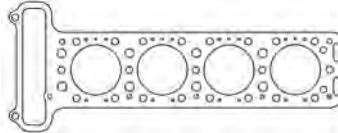

Additional thicknesses available see page 4

D50 Long Block

Head Gasket

CFM-20 Head Gasket

Bore	Thickness	Pkg Qty	Part #	List Price
79mm059"1	C4307-059\$85.33

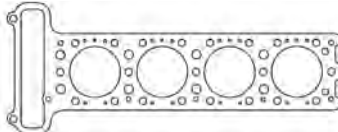

Additional thicknesses available see page 4

Lancia Delta

Head Gasket

MLS Head Gasket

Bore	Thickness	Pkg Qty	Part #	List Price
85mm040"1	C4124-040\$93.53

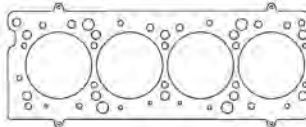

Additional thicknesses available see page 4

FORD / LOTUS

1.6L Sigma 2011-16

Head Gasket

MLX Head Gasket

Bore	Thickness	Pkg Qty	Part #	List Price
82mm028"1	C4963-028\$115.84

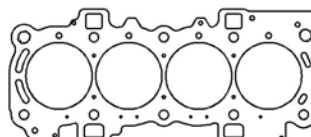

Additional thicknesses available see page 4



Cometic Gasket - An Exclusive NASCAR Performance Product

FORD / LOTUS

1.7L Zetec-S 1997-02 Puma

Head Gasket

MLS Head Gasket				
Bore	Thickness	Pkg Qty	Part #	List Price
83mm	.010"	1	C4223-010	\$58.44

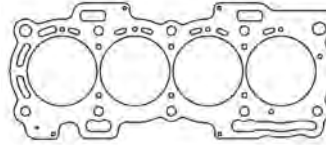

Additional thicknesses available see page 4

2.0L SOHC/DOHC NEP/YB Group A

Head Gasket

MLS Head Gasket				
Bore	Thickness	Pkg Qty	Part #	List Price
92.5mm	.040"	1	C4218-040	\$90.81

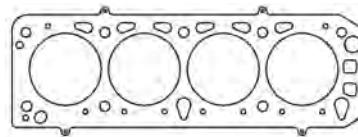

Additional thicknesses available see page 4

Individual Gaskets

Intake Gasket Set			
Application	Part #	List Price	
Cosworth YB	C4502	\$43.63	

Oil Pan Gasket			
Application	Part #	List Price	
Cosworth YB Rails only	C4640	\$16.44	

Exhaust Manifold Gasket Set			
Application	Part #	List Price	
Cosworth YB	C4334	\$17.52	

Front Cover Gasket			
Application	Part #	List Price	
Cosworth YB	C4641	\$9.79	

Valve Cover Gaskets			
Application	Part #	List Price	
Early YB Engine - .060" AFM	C4635	\$29.52	
Late YB Engine - .060" AFM	C4636	\$29.52	

Cooling/Water Pump Gasket			
Application	Part #	List Price	
Water Pump Gasket	C4637	\$5.58	
Water Outlet Gasket	C4638	\$2.48	
Thermostat Gasket	C4639	\$2.33	

2.0L 2012-15 EcoBoost DOHC

Head Gasket

NEW!

MLS Head Gasket				
Bore	Thickness	Pkg Qty	Part #	List Price
89mm	.034"	1	C15317-034	\$98.23
89mm	.066"	1	C15317-066	\$136.33

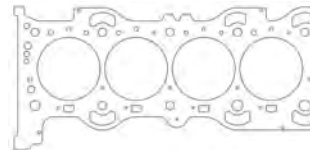

Additional thicknesses available see page 4

2.3L 2016-17 EcoBoost DOHC: 2016-2017 Ford Focus RS

Head Gasket

NEW!

MLS Head Gasket				
Bore	Thickness	Pkg Qty	Part #	List Price
89mm	.040"	1	C15294-040	\$115.84

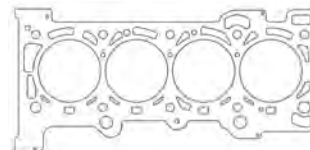

Additional thicknesses available see page 4



Cometic Gasket - An Exclusive NASCAR Performance Product

FORD / LOTUS

Cosworth Ford 4cyl - BDG Belt Driven

Head Gasket

MLS Head Gasket

Bore	Thickness	Pkg Qty	Part #	List Price
91mm	.040"	1	C4494-040	\$93.53

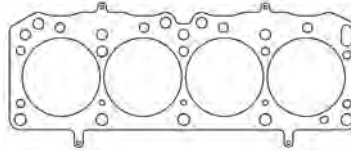

Additional thicknesses available
see page 4

Individual Gaskets

Valve Cover Gasket

Application	Part #	List Price
BDG - Belt Driven .060" AFM	C4886	\$19.25

Cosworth Ford 4cyl - FVA 1.6L/FVC 1.8L Gear Driven

Head Gaskets

MLS Head Gaskets

Bore	Thickness	Pkg Qty	Part #	List Price
87mm	.040"	1	C4138-040	\$93.53
88mm	.040"	1	C4135-040	\$93.53

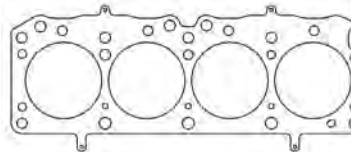

Additional thicknesses available
see page 4

Individual Gaskets

Valve Cover Gasket

Application	Part #	List Price
FVA/FVC .060" AFM	C4887	\$28.22

Oil Pan Gasket

Application	Part #	List Price
FVA/FVC .060" AFM (Rails only)	C4891	\$16.44

Exhaust Gasket Set

Application	Part #	List Price
FVA/FVC .064" AM (4 Pack)	C4888	\$16.64

Rear Cover Gasket

Application	Part #	List Price
FVA/FVC .060" AFM	C4892	\$3.69

Thermostat Housing Gasket

Application	Part #	List Price
FVA/FVC .060" AFM	C4889	\$1.30

Oil Pump Gasket

Application	Part #	List Price
FVA/FVC .060" AFM	C4893	\$2.48

Front Cylinder Head Cover Gasket

Application	Part #	List Price
FVA/FVC .060" AFM	C4890	\$4.86

Front Lower Cover Gasket

Application	Part #	List Price
FVA/FVC .012" Fiber	C4894	\$10.99

Cosworth Ford 4cyl 1.1-2.0L - BDA Series/Lotus Twin Cam, All Pushrod, Chain, & Belt Driven (Kent Engine)

Head Gaskets

MLS Head Gaskets

Bore	Thickness	Pkg Qty	Part #	List Price
82mm	.040"	1	C4102-040	\$93.53
83mm	.040"	1	C4103-040	\$93.53
84mm	.040"	1	C4140-040	\$93.53
85mm	.040"	1	C4133-040	\$93.53
86mm	.040"	1	C4142-040	\$93.53
87mm	.040"	1	C4143-040	\$93.53

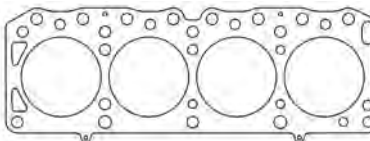

Additional thicknesses available
see page 4



Cometic Gasket - An Exclusive NASCAR Performance Product

FORD / LOTUS

Cosworth Ford 4cyl 1.1-2.0L - BDA Series/Lotus Twin Cam, All Pushrod, Chain, & Belt Driven (Kent Engine)

Individual Gaskets

Valve Cover Gaskets		
Application	Part #	List Price
Lotus Twin Cam Chain Driven.....	C4895	\$24.54
BDA Belt Driven .060" AFM.....	C4896	\$19.25

Oil Pan Gasket		
Application	Part #	List Price
BDA Series .060" AFM (Rails only).....	C4891	\$16.44

Exhaust Gasket Sets		
Application	Part #	List Price
Lotus Twin Cam 2 Bolt (4pk)	C4355-064	\$7.67
BDA 4 Bolt (4pk).....	C4353-064	\$16.39
BDA 3 Bolt (4pk).....	C4354-064	\$16.39

Rear Cover Gasket		
Application	Part #	List Price
FBDA Series .060" AFM	C4892	\$3.69

Intake Gasket Set		
Application	Part #	List Price
BDA Series.....	C4897	\$14.70

Oil Pump Gasket		
Application	Part #	List Price
BDA Series .060" AFM.....	C4893	\$2.48

Thermostat Housing Gasket		
Application	Part #	List Price
BDA Series .060" AFM.....	C4889	\$1.30

Front Lower Cover Gasket		
Application	Part #	List Price
BDA Series .012" Fiber.....	C4894	\$10.99

2.0L ZETEC DOHC 4cyl 1995-04

Head Gasket

MLS Head Gasket				
Bore	Thickness	Pkg Qty	Part #	List Price
87mm027"	1.....	C4279-027	\$89.49

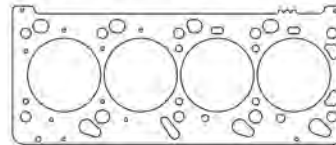

Additional thicknesses available see page 4

Individual Gaskets

Valve Cover Gaskets		
Application	Part #	List Price
2.0L Zetec DOHC 1995-97.....	C4643	\$28.31
2.0L Zetec DOHC 1998-04.....	C4644	\$28.31

Valve Stem Seals		
Application	Part #	List Price
2.0L Zetec 1995-97 (16pk)	3181V-16	\$44.56
2.0L Zetec 1998-04 (16pk)	3182V-16	\$47.99

Exhaust Gasket Sets		
Application	Part #	List Price
2.0L Zetec 1994-04	C4645	\$18.44

Oil Pan Gasket		
Application	Part #	List Price
2.0L Zetec 1995-04	C4649	\$26.39

Intake Gasket Set		
Application	Part #	List Price
2.0L Zetec 1998-04	C4646	\$15.05
2.0L Zetec 1995-97	C4647	\$45.18

Thermostat Gaskets		
Application	Part #	List Price
2.0L Zetec 1995-04 - Seal.....	C4651	\$1.85
2.0L Zetec 1995-04 - Housing.....	C4652	\$4.72

Cam Seal Set		
Application	Part #	List Price
2.0L Zetec 1994-04	C4648	\$13.31

Rear Main Seal Set		
Application	Part #	List Price
2.0L Zetec 1995-04	C4650	\$16.42



Cometic Gasket - An Exclusive NASCAR Performance Product

FORD / LOTUS

2.0L ZETEC DOHC 4cyl 1995-04

Gasket Kits



To purchase a complete gasket kit order both top end and bottom end gasket kit

TOP END GASKET KITS

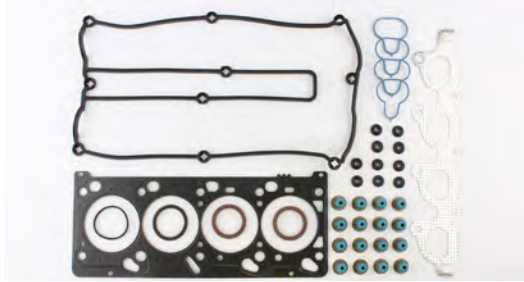

Application	Part #	List Price
2.0L Zetec DOHC 1995-97 87mm Bore	PRO2029T	\$235.95
2.0L Zetec DOHC 1998-04 87mm Bore	PRO2030T	\$235.95

BOTTOM END GASKET KITS

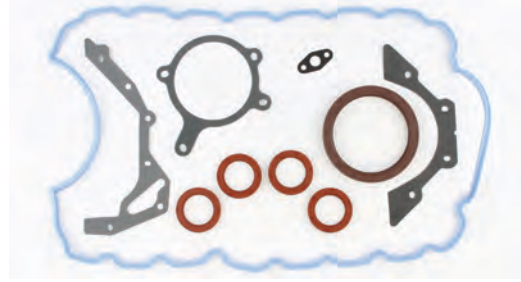

Application	Part #	List Price
2.0L Zetec DOHC 1995-97	PRO2029B	\$109.21
2.0L Zetec DOHC 1998-04	PRO2030B	\$109.21

2.3L "2300" SOHC 1974-97 4cyl

Head Gaskets

MLS Head Gaskets

Bore	Thickness	Pkg Qty	Part #	List Price
3.830"040"1.....	C5369-040	\$73.62
3.940"040"1.....	C5709-040	\$73.62

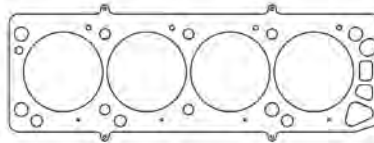

Additional thicknesses available see page 4

Individual Gaskets

Valve Cover Gasket

Application	Part #	List Price
2300 2.3L 1974-93	C4653	\$22.65

Exhaust Gasket Set

Application	Part #	List Price
2300 2.3L 1974-93	C5372-064	\$15.94

Intake Gasket

Application	Part #	List Price
2300 2.3L	C5371-060	\$13.51

Oil Pan Gaskets

Application	Part #	List Price
2300 2.3L 1974-2/19/86	C5373	\$17.00
2300 2.3L 2/20/86-1990	C4669	\$26.62
2300 2.3L 1991-92	C4741	\$20.90
2300 2.3L 1993	C4778	\$20.90

Rear Main Seal Sets

Application	Part #	List Price
2300 2.3L 1974-81 2pc	C5688	\$28.22
2300 2.3L 1982-93 1pc	C5189	\$17.78

Valve Stem Seals

Application	Part #	List Price
2300 2.3L 1974-93 (need 8)	3168V	\$2.43

Water Pump Gasket

Application	Part #	List Price
2300 2.3L 1974-93	C4654	\$2.46



Cometic Gasket - An Exclusive NASCAR Performance Product

FORD / LOTUS

2.3L "2300" SOHC 1974-97 4cyl

Gasket Kits



To purchase a complete gasket kit order both top end and bottom end gasket kit

TOP END GASKET KIT

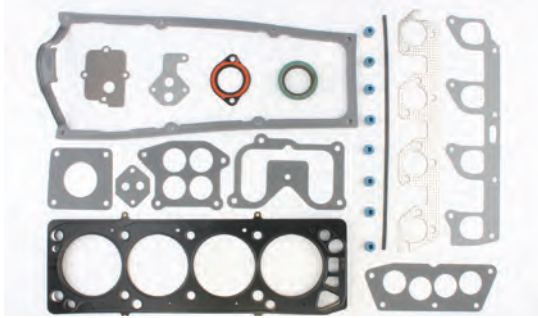

Application	Part #	List Price
2300 2.3L 1974-97 3.830" Bore.....	PRO2031T	\$196.62

BOTTOM END GASKET KIT

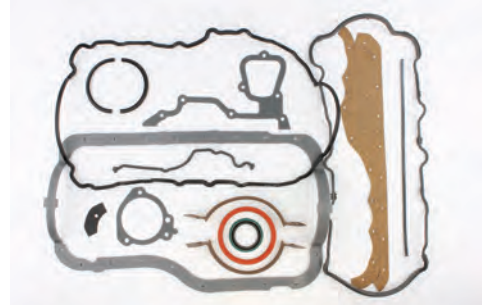

Application	Part #	List Price
2300 2.3L 1974-97	PRO2031B	\$213.00

2.0L 2003-11 & 2.3L 2003-08 Duratec DOHC

Head Gaskets

MLS Head Gaskets

Bore	Thickness	Pkg Qty	Part #	List Price
89.5mm018"	1	C5843-018	\$98.23
92mm018"	1	C5842-018	\$98.23

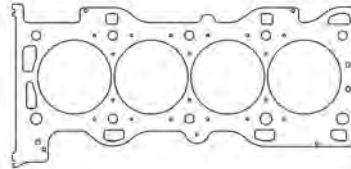

Additional thicknesses available see page 4

Individual Gaskets

Intake Gasket

Application	Part #	List Price
2.3L Duratec 2003-08	C4842-060	\$18.32

Exhaust Manifold Gaskets

Application	Part #	List Price
2.3L Duratec (w/ extra port)	C4840-064	\$24.54
2.3L Duratec (w/o extra port)	C4841-064	\$24.54

2.5L Duratec DOHC 2009 - Present

Head Gasket

MLS Head Gasket

Bore	Thickness	Pkg Qty	Part #	List Price
90mm040"	1	C5906-040	\$98.23

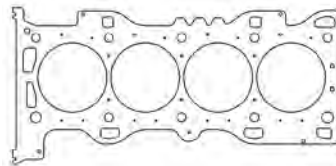

Additional thicknesses available see page 4

3.0L Essex V6 1966-88

Head Gasket

MLS Head Gasket

Bore	Thickness	Pkg Qty	Part #	List Price
95mm040"	1	C4971-040	\$72.36



Additional thicknesses available see page 4



Cometic Gasket - An Exclusive NASCAR Performance Product

CHEVROLET / GM

ECOTEC 4 Cylinder

Head Gaskets

MLS Head Gasket - LSJ 2.0L

Bore	Thickness	Pkg Qty	Part #	List Price
87mm027"1	C5921-027	\$98.23

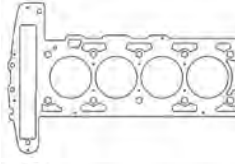

Additional thicknesses available see page 4

MLX Head Gasket - LSJ 2.0L

Bore	Thickness	Pkg Qty	Part #	List Price
87mm040"1	C5032-040	\$136.33

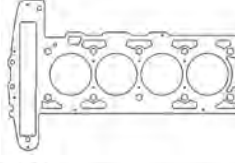

MLX Head Gasket - LNF 2.0L 08-10

Bore	Thickness	Pkg Qty	Part #	List Price
88mm032"1	C15256-032	\$136.33

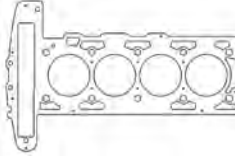

MLX Head Gasket - LTG 2.0L DOHC

Bore	Thickness	Pkg Qty	Part #	List Price
87mm028"1	C4964-028	\$136.33

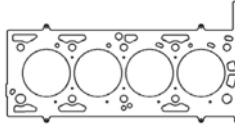

Additional thicknesses available see page 4

NEW!

MLS Head Gaskets - L61/L42 2.2L DOHC

Bore	Thickness	Pkg Qty	Part #	List Price
75mm075"1	C5768-075	\$136.33
87mm040"1	C5768-040	\$98.23
89mm040"1	C5804-040	\$98.23

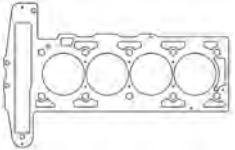

Individual Gaskets

MLS Exhaust Gasket

Application	Part #	List Price
2000-2009 2.2/2.4L	C4150-030	\$23.74

2.2L 134ci "LN2": Cavalier/Sunfire FWD 1998-02, S-10/Sonoma RWD 1994-03

Head Gaskets

MLS Head Gaskets

Bore	Thickness	Pkg Qty	Part #	List Price
90mm030"1	C5914-030	\$98.23
93mm030"1	C5915-030	\$98.23

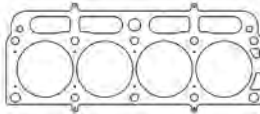

Additional thicknesses available see page 4

2.4L 146ci "LD9" Twin Cam 1996-2001

Head Gaskets

MLS Head Gasket - 1996-99 w/EGR

Bore	Thickness	Pkg Qty	Part #	List Price
3.595"030"1	C5298-030	\$98.23

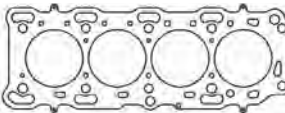

Additional thicknesses available see page 4

MLS Head Gaskets - 1999-01 w/o EGR

Bore	Thickness	Pkg Qty	Part #	List Price
3.595"030"1	C5866-030	\$98.23
3.595"075"1	C5866-075	\$136.33





Cometic Gasket - An Exclusive NASCAR Performance Product

HONDA

D15B1/B2/B7 1988-95, D16A6/A7 1988-91 SOHC

Head Gaskets

MLS Head Gaskets				
Bore	Thickness	Pkg Qty	Part #	List Price
75.5mm	.030"	1	C4117-030	\$93.53
76mm	.030"	1	C4118-030	\$93.53
77mm	.030"	1	C4119-030	\$93.53
78mm	.030"	1	C4120-030	\$93.53
79mm	.030"	1	C4121-030	\$93.53

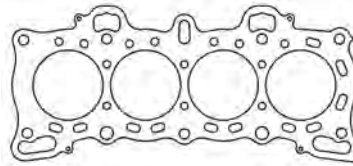

Additional thicknesses available see page 4

Individual Gaskets

Valve Cover Gasket Set		
Application	Part #	List Price
D15B1/B2/B7, D16A6/A7	C4701	\$31.71

Oil Pan Gasket		
Application	Part #	List Price
D15B1/B2/B7, D16A6/A7	C4660	\$34.65

Intake Gasket		
Application	Part #	List Price
D15B1/B2/B7, D16A6/A7	C4702-060	\$13.20

Rear Main Seal Set		
Application	Part #	List Price
D15B1/B2/B7, D16A6/A7	C4663	\$17.53

Exhaust Manifold Gasket		
Application	Part #	List Price
D15B1/B2/B7, D16A6/A7 - MLS	C4164-030	\$23.74

Front Crank/Oil Pump Seal		
Application	Part #	List Price
D15B1/B2/B7, D16A6/A7	C4664	\$4.27

Valve Stem Seals (sold individually)		
Application	Part #	List Price
D15B1/B2/B7, D16A6/A7	3170V	\$1.30

Timing Cover Dust Seal Sets		
Application	Part #	List Price
D15B1/B2/B7, D16A6/A7 - Lower	C4661	\$18.92
D15B1/B2/B7, D16A6/A8 - Upper	C4898	\$9.39

Cam Seal		
Application	Part #	List Price
D15B1/B2/B7, D16A6/A7	C4703	\$4.43

Thermostat Seal Set		
Application	Part #	List Price
D15B1/B2/B7, D16A6/A7	C4704	\$8.21

Water Pump Mounting O-ring		
Application	Part #	List Price
D15B1/B2/B7, D16A6/A7	C4700	\$3.76

Gasket Kits



To purchase a complete gasket kit order both top end and bottom end gasket kit

TOP END GASKET KITS



Application	Part #	List Price
D15B1/B2/B7 88-95 76mm Bore	PRO2032T	\$203.18
D16A6/A7 88-91 76mm Bore	PRO2034T	\$174.77

BOTTOM END GASKET KIT



Application	Part #	List Price
D15B1/B2/B7, D16A6/A7	PRO2032B	\$76.43



Cometic Gasket - An Exclusive NASCAR Performance Product

HONDA

D16A1/A9 DOHC 1986-89

Head Gaskets

MLS Head Gaskets

Bore	Thickness	Pkg Qty	Part #	List Price
75.5mm	.030"	1	C4522-030	\$93.53
76mm	.030"	1	C4524-030	\$93.53
77mm	.030"	1	C4525-030	\$93.53
78mm	.030"	1	C4526-030	\$93.53

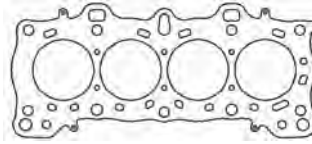

Additional thicknesses available see page 4

Individual Gaskets

Valve Cover Gasket Set

Application	Part #	List Price
D16A1/A9 1986-89	C4706	\$31.71

Oil Pan Gasket

Application	Part #	List Price
D16A1/A9 1986-89	C4660	\$34.65

Intake Gasket

Application	Part #	List Price
D16A1/A9 1986-89	C4707-046	\$4.22

Rear Main Seal Set

Application	Part #	List Price
D16A1/A9 1986-89	C4663	\$17.53

Exhaust Manifold Gasket

Application	Part #	List Price
D16A1/A9 1986-89	C4708	\$8.44

Front Crank/Oil Pump Seal

Application	Part #	List Price
D16A1/A9 1986-89	C4664	\$4.27

Valve Stem Seals (sold individually)

Application	Part #	List Price
D16A1/A9 1986-89	3177V	\$2.01

Water Pump Mounting O-ring

Application	Part #	List Price
D16A1/A9 1986-89	C4700	\$3.76

Cam Seal

Application	Part #	List Price
D16A1/A9 1986-89	C4709	\$8.76

Thermostat Seal

Application	Part #	List Price
D16A1/A9 1986-89	C4710	\$5.19

Gasket Kits



To purchase a complete gasket kit order both top end and bottom end gasket kit

TOP END GASKET KIT

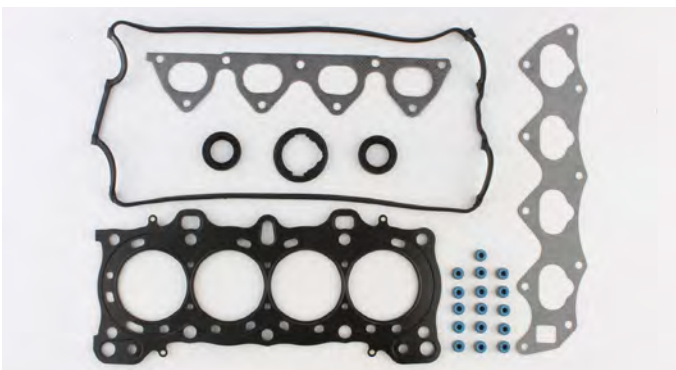

Application	Part #	List Price
D16A1/A9 1986-89 76mm Bore	PRO2033T	\$169.68

BOTTOM END GASKET KIT



Application	Part #	List Price
D16A1/A9 1986-89	PRO2033B	\$63.60



Cometic Gasket - An Exclusive NASCAR Performance Product

HONDA

D16Z6, D16Y5/Y7/Y8, D15Z1 1992-00 SOHC

Head Gaskets

MLS Head Gaskets				
Bore	Thickness	Pkg Qty	Part #	List Price
75.5mm030"1	C4251-030	\$93.53
76mm030"1	C4195-030	\$93.53
77mm030"1	C4196-030	\$93.53
78mm030"1	C4167-030	\$93.53
79mm030"1	C4197-030	\$93.53

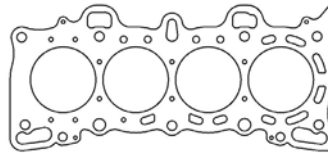

Additional thicknesses available see page 4

Individual Gaskets

Valve Cover Gasket Sets		
Application	Part #	List Price
D16Z6 1992-95	C4655	\$28.31
D16Y5/Y7/Y8 1996-00	C4665	\$22.65

Throttle Body Gaskets		
Application	Part #	List Price
D16Z6 1992-95	C4657-032	\$5.73
D16Y5/Y7/Y8 1996-00	C4667-032	\$5.73

Intake Gaskets		
Application	Part #	List Price
D16Z6 1992-95	C4702-060	\$13.20
D16Y5/Y7/Y8 1996-00	C4666	\$11.71

Oil Pan Gaskets		
Application	Part #	List Price
D16Z6 1992-95	C4660	\$34.65
D16Y5/Y8 1996-00	C4670	\$20.94
D16Y7 1996-00	C4899	\$20.94

Exhaust Manifold Gasket		
Application	Part #	List Price
D16Z6, D16Y5/Y7/Y8 - MLS	C4164-030	\$23.74

Rear Main Seal Set		
Application	Part #	List Price
D16Z6, D16Y5/Y7/Y8	C4663	\$17.54

Valve Stem Seals (sold individually)		
Application	Part #	List Price
D16Z6, D16Y5/Y7/Y8	3170V	\$1.30

Front Crank/Oil Pump Seal		
Application	Part #	List Price
D16Z6, D16Y5/Y7/Y8	C4664	\$4.27

Cam Seal		
Application	Part #	List Price
D16Z6, D16Y5/Y7/Y8	C4658	\$9.95

Timing Cover Dust Seal Set		
Application	Part #	List Price
D16Z6, D16Y5/Y7/Y8 - Lower	C4661	\$18.92

Thermostat Seal		
Application	Part #	List Price
D16Z6, D16Y5/Y7/Y8	C4659	\$5.67

Water Pump Mounting O-ring		
Application	Part #	List Price
D16Z6, D16Y5/Y7/Y8	C4662	\$4.72

Gasket Kits

To purchase a complete gasket kit order both top end and bottom end gasket kit

TOP END GASKET KITS

BOTTOM END GASKET KIT

Application	Part #	List Price
D16Z6 1992-95 76mm Bore	PRO2000T	\$169.68
D16Y5/Y7/Y8 1996-00 76mm Bore	PRO2001T	\$170.31

Application	Part #	List Price
D16Z6 1992-95	PRO2000B	\$58.91
D16Y5/Y7/Y8 1996-00	PRO2001B	\$62.02



Cometic Gasket - An Exclusive NASCAR Performance Product

HONDA

D17A1, A2, A6 1.7L SOHC 2001-05

Head Gaskets

MLS Head Gaskets

Bore	Thickness	Pkg Qty	Part #	List Price
76mm	.027"	1	C4474-027	\$93.53
77mm	.027"	1	C4473-027	\$93.53
78mm	.027"	1	C4472-027	\$93.53
79mm	.027"	1	C4471-027	\$93.53

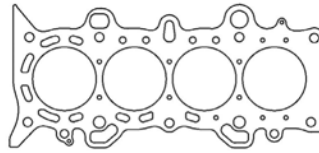

Additional thicknesses available
see page 4

Individual Gaskets

Valve Stem Seals (sold individually)

Application	Part #	List Price
D17A1/A2/A6	3170V	\$1.30

Rear Main Seal

Application	Part #	List Price
D17A1/A2/A6	C4678	\$14.06

Cam Seal

Application	Part #	List Price
D17A1/A2/A6	C4658	\$9.95

Water Pump Mounting O-ring

Application	Part #	List Price
D17A1/A2/A6	C4662	\$4.72

B16A2/A3, B18C1/C5 1.6/1.8L DOHC VTEC

Head Gaskets

MLS Head Gaskets

Bore	Thickness	Pkg Qty	Part #	List Price
81mm	.030"	1	C4231-030	\$93.53
81.5mm	.030"	1	C4232-030	\$93.53
82mm	.030"	1	C4168-030	\$93.53
83mm	.030"	1	C4189-030	\$93.53
84mm	.030"	1	C4188-030	\$93.53
85mm	.030"	1	C4182-030	\$93.53

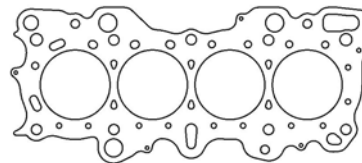

Additional thicknesses available
see page 4

Individual Gaskets

Valve Cover Gasket Set

Application	Part #	List Price
B16A2/A3 & B18C1/C5	C4628	\$22.65

Thermostat Seal

Application	Part #	List Price
B16A2/A3 & B18C1/C5	C4659	\$5.67

Intake Gaskets

Application	Part #	List Price
B16A2/A3 & B18C5	C4671-060	\$22.61
B18C1	C4674	\$17.13

Throttle Body Gaskets

Application	Part #	List Price
B16A3/B18C1 94-95	C4672-032	\$5.73
B16A2/B18C1/C5 96-01	C4656-032	\$5.73

Exhaust Manifold Gasket

Application	Part #	List Price
B16A2/A3 & B18C1/C5 - MLS	C4151-030	\$19.41

Oil Pan Gasket

Application	Part #	List Price
B16A2/A3 & B18C1/C5	C4676	\$19.58

Valve Stem Seals (sold individually)

Application	Part #	List Price
D16Z6, D16Y5/Y7/Y8	3170V	\$1.30

Rear Main Seal

Application	Part #	List Price
B16A2/A3 & B18C1/C5	C4678	\$14.06

Cam Seal Set

Application	Part #	List Price
B16A2/A3 & B18C1/C5	C4675	\$17.05

Water Pump Mounting O-ring

Application	Part #	List Price
B16A2/A3 & B18C1/C5	C4677	\$2.46

See page 85 for StreetPro gasket kits



Cometic Gasket - An Exclusive NASCAR Performance Product

HONDA

B16A2/A3, B18C1/C5 1.6/1.8L DOHC VTEC

Gasket Kits



To purchase a complete gasket kit order both top end and bottom end gasket kit

TOP END GASKET KIT



Application	Part #	List Price
B16A2/A3, B18C5 82mm Bore.....	PRO2002T	\$196.62
B18C1 GS-R 82mm Bore.....	PRO2003T	\$218.47

BOTTOM END GASKET KIT



Application	Part #	List Price
B16A2/A3, B18C1/C5.....	PRO2003B	\$62.12

B18A1/B18B1 1.8L DOHC non-VTEC 1990-01

Head Gaskets

MLS Head Gaskets

Bore	Thickness	Pkg Qty	Part #	List Price
81mm	.030"	1	C4238-030	\$93.53
81.5mm	.030"	1	C4239-030	\$93.53
82mm	.030"	1	C4173-030	\$93.53
83mm	.030"	1	C4181-030	\$93.53
84mm	.030"	1	C4180-030	\$93.53
85mm	.030"	1	C4175-030	\$93.53

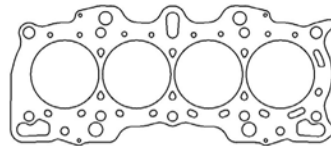

Additional thicknesses available see page 4

Individual Gaskets

Valve Cover Gasket Set

Application	Part #	List Price
B18A1/B1	C4679	\$22.65

Throttle Body Gasket

Application	Part #	List Price
B18A1/B1	C4681	\$5.73

Intake Gasket

Application	Part #	List Price
B18A1/B1 .094" KF.....	C4680-094	\$21.17

Thermostat Seal

Application	Part #	List Price
B18A1/B1	C4659	\$5.67

Exhaust Manifold Gasket

Application	Part #	List Price
B18A1/B1 - .030" MLS.....	C4151-030	\$19.41

Oil Pan Gasket Set

Application	Part #	List Price
B18A1/B1	C4676	\$19.58

Valve Stem Seals (sold individually)

Application	Part #	List Price
B18A1/B1	3177V	\$2.01

Rear Main Seal Set

Application	Part #	List Price
B18A1/B1	C4678	\$14.06

Cam Seal Set

Application	Part #	List Price
B18A1/B1	C4709	\$8.76

Water Pump Mounting O-ring

Application	Part #	List Price
B18A1/B1	C4677	\$2.46

See page 86 for StreetPro gasket kits



Cometic Gasket - An Exclusive NASCAR Performance Product

HONDA

B18A1/B18B1 1.8L DOHC non-VTEC 1990-01

Gasket Kits



To purchase a complete gasket kit order both top end and bottom end gasket kit

TOP END GASKET KIT



Application	Part #	List Price
B18A1/B1 1990-01 82mm Bore.....	PRO2004T	\$192.25

BOTTOM END GASKET KIT



Application	Part #	List Price
B18A1/B1 1990-01	PRO2004B	\$58.91

B Series Hybrid (VTEC Head/non-VTEC Block)

Head Gaskets

MLS Head Gaskets

Bore	Thickness	Pkg Qty	Part #	List Price
81mm	.030"	1	C4237-030	\$93.53
81.5mm	.030"	1	C4236-030	\$93.53
82mm	.030"	1	C4191-030	\$93.53
83mm	.030"	1	C4192-030	\$93.53
84mm	.030"	1	C4193-030	\$93.53
84.5mm	.030"	1	C4241-030	\$93.53
85mm	.030"	1	C4194-030	\$93.53

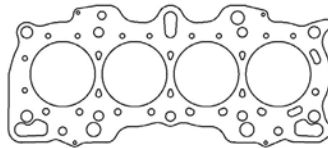

Additional thicknesses available see page 4

Individual Gaskets

Valve Cover Gasket Set

Application	Part #	List Price
B16A2/A3 & B18C1/C5	C4628	\$22.65

Thermostat Seal

Application	Part #	List Price
B Series	C4659	\$5.67

Intake Gaskets

Application	Part #	List Price
B16A2/A3 & B18C5	C4674	\$17.13
B18C1	C4671-060	\$22.61

Throttle Body Gaskets

Application	Part #	List Price
B16A3/B18C1 94-95.....	C4672-032	\$5.73
B16A2/B18C1/C5 96-01.....	C4656-032	\$5.73

Exhaust Manifold Gasket

Application	Part #	List Price
B16A2/A3 & B18C1/C5 - MLS.....	C4151-030	\$19.41

Oil Pan Gasket Set

Application	Part #	List Price
B Series	C4676	\$19.58

Valve Stem Seals (sold individually)

Application	Part #	List Price
B16A2/A3 & B18C1/C5	3170V	\$1.30

Rear Main Seal Set

Application	Part #	List Price
B Series	C4678	\$14.06

Cam Seal Set

Application	Part #	List Price
B16A2/A3 & B18C1/C5	C4675	\$17.05

Water Pump Mounting O-ring

Application	Part #	List Price
B Series	C4677	\$2.46

See page 87 for StreetPro gasket kits



Cometic Gasket - An Exclusive NASCAR Performance Product

HONDA

B Series Hybrid (VTEC Head/non-VTEC Block)

Gasket Kits



To purchase a complete gasket kit order both top end and bottom end gasket kit

TOP END GASKET KITS



Application	Part #	List Price
B20 w/B18C1 Head (GS-R) 84.5mm Bore	PRO2049T	\$218.47
B20 w/B16A2/A3/B18C5 Head 84.5mm Bore ..	PRO2050T	\$196.62

BOTTOM END GASKET KIT



Application	Part #	List Price
B Series	PRO2004B	\$57.91

B20B4, B20Z2 2.0L DOHC non-VTEC 1997-01

Head Gasket

MLS Head Gasket

Bore	Thickness	Pkg Qty	Part #	List Price
85mm030"	1	C4250-030	\$93.53

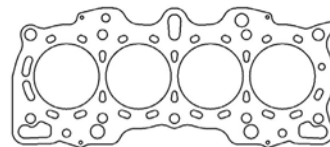

Additional thicknesses available see page 4

Individual Gaskets

Valve Cover Gasket Set

Application	Part #	List Price
B20B4, B20Z2	C4679	\$22.65

Thermostat Seal

Application	Part #	List Price
B20B4, B20Z2	C4659	\$5.67

Intake Gasket

Application	Part #	List Price
B20B4, B20Z2 .094" KF	C4680-094	\$21.17

Oil Pan Gasket Set

Application	Part #	List Price
B18A1/B1	C4676	\$19.58

Exhaust Manifold Gasket

Application	Part #	List Price
B20B4, B20Z2 - .030" MLS	C4151-030	\$19.41

Rear Main Seal

Application	Part #	List Price
B20B4, B20Z2	C4678	\$14.06

Valve Stem Seals (sold individually)

Application	Part #	List Price
B20B4, B20Z2	3177V	\$2.01

Water Pump Mounting O-ring

Application	Part #	List Price
B20B4, B20Z2	C4677	\$2.46

Cam Seal Set

Application	Part #	List Price
B20B4, B20Z2	C4709	\$8.76

See page 88 for StreetPro gasket kits



Cometic Gasket - An Exclusive NASCAR Performance Product

HONDA

B20B4, B20Z2 2.0L DOHC non-VTEC 1997-01

Gasket Kits



To purchase a complete gasket kit order both top end and bottom end gasket kit

TOP END GASKET KIT



Application	Part #	List Price
B20B4, B20Z2 85mm Bore.....	PRO2035T	\$185.69

BOTTOM END GASKET KIT



Application	Part #	List Price
B Series.....	PRO2004B	\$58.91

B20A5 2.0L 1988-91

Head Gaskets

MLS Head Gaskets

Bore	Thickness	Pkg Qty	Part #	List Price
81.5mm	.045"	1	C4564-045	\$93.53
82mm	.045"	1	C4565-045	\$93.53
83mm	.045"	1	C4566-045	\$93.53
84mm	.045"	1	C4567-045	\$93.53

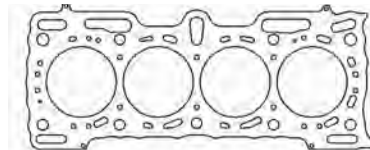

Additional thicknesses available see page 4

F20B 2.0L DOHC 1997-01

Head Gasket

NEW!

MLS Head Gasket

Bore	Thickness	Pkg Qty	Part #	List Price
86mm	.027"	1	C4634-027	\$93.53
86mm	.036"	1	C4634-036	\$93.53

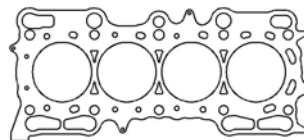

Additional thicknesses available see page 4

B21A1 2.1L 1990-91

Head Gaskets

NEW!

MLS Head Gaskets

Bore	Thickness	Pkg Qty	Part #	List Price
84mm	.040"	1	C4586-040	\$93.53
83mm	.045"	1	C4585-045	\$93.53
84mm	.045"	1	C4586-045	\$93.53

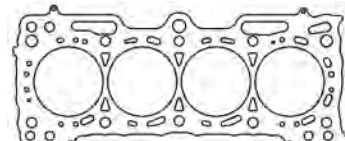

Additional thicknesses available see page 4



Cometic Gasket - An Exclusive NASCAR Performance Product

HONDA

K20A1, K20A2, K20A3 2.0L 2001+, K24A 2.4L 2003+

Head Gaskets

MLS Head Gaskets				
Bore	Thickness	Pkg Qty	Part #	List Price
86mm030"1	C4300-030	\$93.53
87mm030"1	C4311-030	\$93.53
88mm030"1	C4312-030	\$93.53
89mm030"1	C4313-030	\$93.53

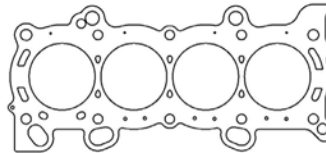

Additional thicknesses available see page 4

NEW! MLX Head Gaskets				
Bore	Thickness	Pkg Qty	Part #	List Price
89mm032"1	C4596-032	\$131.16
89mm036"1	C4596-036	\$131.16
89mm044"1	C4596-044	\$131.16

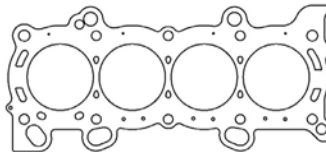

Additional thicknesses available see page 4

Individual Gaskets

Exhaust Manifold Gaskets		
Application	Part #	List Price
K20A1/A3 2002-04 - MLS	C4160-030	\$23.74
K20A2 - MLS	C4162-030	\$23.74

Rear Main Seal		
Application	Part #	List Price
K-Series 2002+	C4705	\$32.31

Intake Gasket		
Application	Part #	List Price
K20A2/A3 2001+	C4668	\$24.27

K20Z3 2.0L 2006-11

Head Gaskets

MLS Head Gaskets				
Bore	Thickness	Pkg Qty	Part #	List Price
86mm030"1	C4561-030	\$95.53
87mm030"1	C4562-030	\$95.53

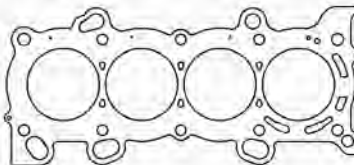

Additional thicknesses available see page 4

Individual Gaskets

Rear Main Seal		
Application	Part #	List Price
K-Series 2002+	C4705	\$32.31

K24Z2/K24Z7 2.4L 2012-15

Head Gaskets

NEW! MLS Head Gaskets				
Bore	Thickness	Pkg Qty	Part #	List Price
87mm030"1	C4594-030	\$95.53
89mm030"1	C4595-030	\$95.53
89mm036"1	C4595-036	\$95.53

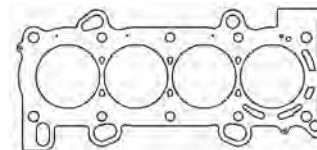

Additional thicknesses available see page 4

Individual Gaskets

Rear Main Seal		
Application	Part #	List Price
K-Series 2002+	C4705	\$32.31



Cometic Gasket - An Exclusive NASCAR Performance Product

HONDA

H22A1/H22A2 2.2L DOHC VTEC 1992-96

Head Gaskets

MLS Head Gaskets

Bore	Thickness	Pkg Qty	Part #	List Price
87mm	.030"	1	C4255-030	\$93.53
88mm	.030"	1	C4198-030	\$93.53
89mm	0.03	1	C4185-030	\$93.53

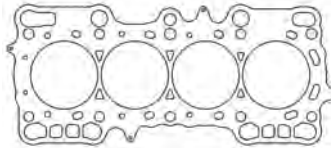

Additional thicknesses available
see page 4

Individual Gaskets

Exhaust Manifold Gasket

Application	Part #	List Price
H22A1/H22A2 - MLS	C4155-030	\$29.15

Water Pump Gasket

Application	Part #	List Price
H22A1/H22A2	C4244	\$5.67

Valve Stem Seals (sold individually)

Application	Part #	List Price
H22A1/H22A2	3170V	\$1.30

Oil Pan Gasket Set

Application	Part #	List Price
H22A1/H22A2	C4158	\$20.90

Thermostat Seal

Application	Part #	List Price
H22A1/H22A2	C4659	\$5.67

Rear Main Seal

Application	Part #	List Price
H22A1/H22A2	C4678	\$14.06

H22A4 1997-01, H22A7 1998-03 2.2L DOHC

Head Gaskets

NEW!

MLS Head Gaskets

Bore	Thickness	Pkg Qty	Part #	List Price
87mm	.018"	1	C4252-018	\$93.53
87mm	.030"	1	C4252-030	\$93.53
88mm	.030"	1	C4253-030	\$93.53
89mm	.030"	1	C4254-030	\$93.53

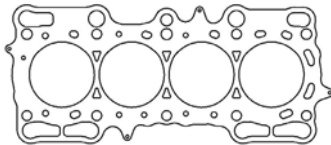

Additional thicknesses available
see page 4

Individual Gaskets

Exhaust Manifold Gasket

Application	Part #	List Price
H22A4/H22A7 - MLS	C4155-030	\$29.15

Water Pump Gasket

Application	Part #	List Price
H22A4/H22A7	C4244	\$5.67

Valve Stem Seals (sold individually)

Application	Part #	List Price
H22A4/H22A7	3170V	\$1.30

Oil Pan Gasket Set

Application	Part #	List Price
H22A4/H22A7	C4158	\$20.90

Thermostat Seal

Application	Part #	List Price
H22A4/H22A7	C4659	\$5.67

Rear Main Seal

Application	Part #	List Price
H22A4/H22A7	C4678	\$14.06

H23A1 2.3L DOHC VTEC 1992-96

Head Gaskets

MLS Head Gaskets

Bore	Thickness	Pkg Qty	Part #	List Price
87.5mm	.030"	1	C4553-030	\$93.53
88mm	.030"	1	C4554-030	\$93.53
89mm	0.03	1	C4555-030	\$93.53

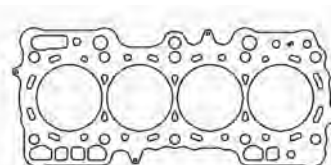

Additional thicknesses available
see page 4



Cometic Gasket - An Exclusive NASCAR Performance Product

HONDA

F22B1/B4/B5/B8 2.2L SOHC 1994-97, *F23A1 1998-02

Head Gaskets

MLS Head Gaskets				
Bore	Thickness	Pkg Qty	Part #	List Price
86mm	.027"	1	C4618-027	\$93.53
87mm	.027"	1	C4619-027*	\$93.53
88mm	.027"	1	C4620-027*	\$93.53
89mm	.027"	1	C4621-027*	\$93.53

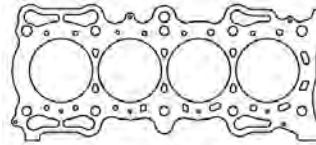

Additional thicknesses available
see page 4

Individual Gaskets

Exhaust Manifold Gasket		
Application	Part #	List Price
F22B1/F23A1 1994-01 .064" AM	C4190-064	\$11.88

F20C1/C2, F22C1 2.0/2.2L DOHC VTEC 1999-09

Head Gaskets

MLS Head Gaskets				
Bore	Thickness	Pkg Qty	Part #	List Price
87.5mm	.030"	1	C4625-030	\$93.53
88mm	.030"	1	C4626-030	\$93.53
88.5mm	.030"	1	C4627-030	\$93.53
89mm	.030"	1	C4335-030	\$93.53

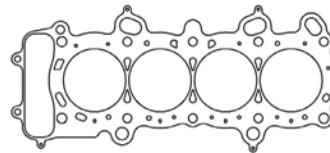

Additional thicknesses available
see page 4

Individual Gaskets

Exhaust Manifold Gasket		
Application	Part #	List Price
F20C1/C2 99-09 - MLS	C4159-030	\$23.74

C30A1, C32B1 DOHC 3.0/3.2L V6 1991-05

Head Gaskets

MLS Head Gaskets				
Bore	Thickness	Pkg Qty	Part #	List Price
91mm	.030"	1	C4550-030	\$105.21
93mm	.030"	1	C4551-030	\$105.21
95mm	.030"	1	C4277-030	\$105.21

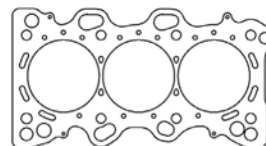

Additional thicknesses available
see page 4

J32A2 3.5L SOHC V6 2001-04 Stock and Darton Sleeves

Head Gaskets

MLS Head Gasket				
Bore	Thickness	Pkg Qty	Part #	List Price
90mm	.027"	1	C4382-027	\$85.33

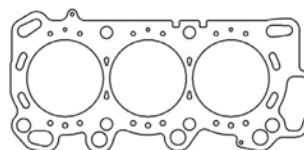

Additional thicknesses available
see page 4



Cometic Gasket - An Exclusive NASCAR Performance Product

HYUNDAI

2.0L Theta II Turbo 4 Cylinder

2010-Up Genesis Coupe, 2011 Sonata Limited, 2009-2013 Kia Forte

Head Gaskets

MLX Head Gasket

Bore	Thickness	Pkg Qty	Part #	List Price
88mm	.032"	1	C4953-032	\$115.84

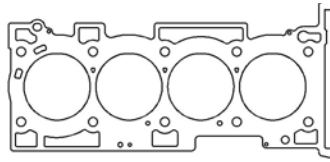

Additional thicknesses available
see page 4

3.8L G6DA DOHC V6

2007-09 Azera, 2007-09 Entourage, 2009+Up Genesis, 2007-09 Veracruz

Head Gaskets

MLX Head Gasket - Left Side

Bore	Thickness	Pkg Qty	Part #	List Price
98mm	.032"	1	C4632-032	\$96.70

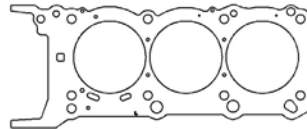

Additional thicknesses available
see page 4

MLX Head Gasket - Right Side

Bore	Thickness	Pkg Qty	Part #	List Price
98mm	.032"	1	C4633-032	\$96.70

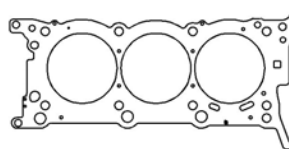

Additional thicknesses available
see page 4

JAGUAR

3.4L DOHC Inline 6

48-53 XK120, 54-57 XK140, 57-61 XK150, 50-57 Mark VII, 56-58 Mark VIII, 57-59 Mark I,
59-67 Mark II, 67-68 340 Mark II, 63-68 S-Type

Head Gaskets

MLS Head Gaskets

Bore	Thickness	Pkg Qty	Part #	List Price
83mm	.040"	1	C4281-040	\$163.76
85mm	.040"	1	C4303-040	\$163.76

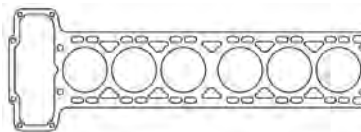

Additional thicknesses available
see page 4

CFM-20 Head Gasket

Bore	Thickness	Pkg Qty	Part #	List Price
83mm	.059"	1	C4302-059	\$128.68
85mm	.059"	1	C4304-059	\$128.68

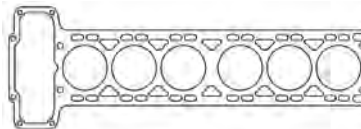

Additional thicknesses available
see page 4

Individual Gaskets

Cam Cover Gasket Set

Application	Part #	List Price
3.4/3.8/4.2L (Trim to Fit)	C4545-060	\$42.07

Oil Pan Gasket

Application	Part #	List Price
3.4/3.8/4.2L .060" AFM	C4259-060	\$23.35

Intake Manifold Gaskets

Application	Part #	List Price
3.8/4.2L Str Port Head	C4230-060	\$17.76
3.4/3.8L B Type Head	C4244-060	\$17.76

Engine Cover Gaskets

Application	Part #	List Price
Front Main Seal Gasket	C4673-188	\$3.19
Rear Main Seal Gasket	C4901-188	\$3.19

See page 93 for additional gaskets



Cometic Gasket - An Exclusive NASCAR Performance Product

JAGUAR

3.4L DOHC Inline 6

48-53 XK120, 54-57 XK140, 57-61 XK150, 50-57 Mark VII, 56-58 Mark VIII, 57-59 Mark I,
59-67 Mark II, 67-68 340 Mark II, 63-68 S-Type

Individual Gaskets

Exhaust Manifold Gasket		
Application	Part #	List Price
3.4/3.8/4.2L.....	C4217-059	\$10.76

Timing Cover Gasket		
Application	Part #	List Price
3.4/3.8/E4.2L .018" AFM.....	C4336-018	\$19.03

Thermostat Gaskets		
Application	Part #	List Price
Series 1 1965-67	C4375-060	\$2.33
Series 2 1968-71	C4379-060	\$2.33

Engine Oil Gaskets		
Application	Part #	List Price
Oil Feed Gasket.....	C4949-032	\$2.33
Oil Filter Housing Gasket.....	C4179-032	\$3.51

Breather Cover Gasket Set		
Application	Part #	List Price
3.4/3.8/4.2L.....	C4544-060	\$7.02

Water Pump Gasket		
Application	Part #	List Price
3.4/3.8/E4.2L .018" AFM.....	C4337-018	\$5.99

3.8L DOHC Inline 6

58-61 XK150 3.8, 58-61 XK150 3.8S, 58-61 Mark IX, 61-64 Mark X 3.8, 59-67 Mark II, 61-64 E-Type Series 1 3.8,
63-68 S-Type 3.8

Head Gaskets

MLS Head Gaskets				
Bore	Thickness	Pkg Qty	Part #	List Price
88mm040"	1.....	C4282-040	\$163.76
89mm040"	1.....	C4306-040	\$163.76

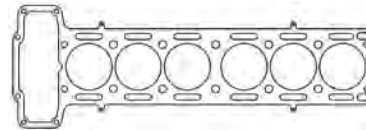

Additional thicknesses available
see page 4

CFM-20 Head Gasket				
Bore	Thickness	Pkg Qty	Part #	List Price
87mm059"	1.....	C4305-059	\$128.68
89mm059"	1.....	C4125-059	\$128.68

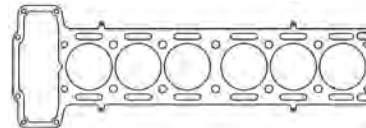

Additional thicknesses available
see page 4

Individual Gaskets

Cam Cover Gasket Set		
Application	Part #	List Price
3.4/3.8/4.2L (Trim to Fit)	C4545-060	\$42.07

Oil Pan Gasket		
Application	Part #	List Price
3.4/3.8/4.2L .060" AFM.....	C4259-060	\$23.35

Intake Manifold Gaskets		
Application	Part #	List Price
3.8/4.2L Str Port Head	C4230-060	\$17.67
3.4/3.8L B Type Head	C4244-060	\$17.67

Engine Cover Gaskets		
Application	Part #	List Price
Front Main Seal Gasket.....	C4673-188	\$3.19
Rear Main Seal Gasket	C4901-188	\$3.19

Exhaust Manifold Gasket		
Application	Part #	List Price
3.4/3.8/4.2L.....	C4217-059	\$10.76

Timing Cover Gasket		
Application	Part #	List Price
3.4/3.8/E4.2L .018" AFM.....	C4336-018	\$19.03

Thermostat Gaskets		
Application	Part #	List Price
Series 1 1965-67	C4375-060	\$2.33
Series 2 1968-71	C4379-060	\$2.33

Engine Oil Gaskets		
Application	Part #	List Price
Oil Feed Gasket.....	C4949-032	\$2.34
Oil Filter Housing Gasket.....	C4179-032	\$3.51

Breather Cover Gasket Set		
Application	Part #	List Price
3.4/3.8/4.2L.....	C4544-060	\$7.02

Water Pump Gasket		
Application	Part #	List Price
3.4/3.8/E4.2L .018" AFM.....	C4337-018	\$5.99



Cometic Gasket - An Exclusive NASCAR Performance Product

JAGUAR

3.9/4.2L AJ33 V8 UK Engine

Head Gaskets

MLS Head Gasket - Left Side

Bore	Thickness	Pkg Qty	Part #	List Price
93mm	.030"	1	C4376-030	\$98.18

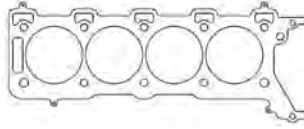

Additional thicknesses available
see page 4

MLS Head Gasket - Right Side

Bore	Thickness	Pkg Qty	Part #	List Price
93mm	.030"	1	C4377-030	\$98.18

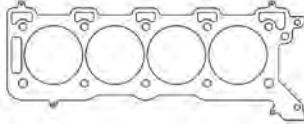

Additional thicknesses available
see page 4

3.9/4.2L AJ30/AJ35 V8 US Engine

Head Gaskets

MLS Head Gaskets - Left Side

Bore	Thickness	Pkg Qty	Part #	List Price
87mm	.030"	1	C5772-030	\$100.67
93mm	.030"	1	C5773-030	\$100.67

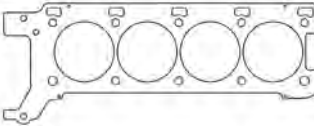

Additional thicknesses available
see page 4

MLS Head Gaskets - Right Side

Bore	Thickness	Pkg Qty	Part #	List Price
87mm	.030"	1	C5770-030	\$100.67
93mm	.030"	1	C5771-030	\$100.67

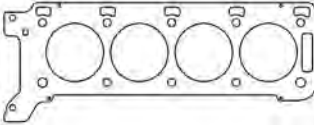

Additional thicknesses available
see page 4

4.2L Inline 6 65-67 Series 1, 64-66 Mark X 4.2, 66-68 420

Head Gaskets

CFM-20 Head Gasket

Bore	Thickness	Pkg Qty	Part #	List Price
93mm	.059"	1	C4338-059	\$128.68

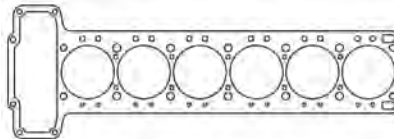

Additional thicknesses available
see page 4

Individual Gaskets

Cam Cover Gasket Set

Application	Part #	List Price
3.4/3.8/4.2L (Trim to Fit)	C4545-060	\$42.07

Oil Pan Gasket

Application	Part #	List Price
3.4/3.8/4.2L .060" AFM	C4259-060	\$23.35

Intake Manifold Gaskets

Application	Part #	List Price
3.8/4.2L Str Port Head	C4230-060	\$17.67
3.4/3.8L B Type Head	C4244-060	\$17.67

Engine Cover Gaskets

Application	Part #	List Price
Front Main Seal Gasket	C4902-018	\$19.03
Rear Main Seal Gasket	C4901-188	\$3.19

Exhaust Manifold Gasket

Application	Part #	List Price
3.4/3.8/4.2L	C4217-059	\$10.76

Timing Cover Gasket

Application	Part #	List Price
3.4/3.8/E4.2L .018" AFM	C4336-018	\$19.03

Thermostat Gaskets

Application	Part #	List Price
Series 1 1965-67	C4375-060	\$2.33
Series 2 1968-71	C4379-060	\$2.33

Engine Oil Gaskets

Application	Part #	List Price
Oil Feed Gasket	C4949-032	\$2.33
Oil Filter Housing Gasket	C4179-032	\$3.51

Breather Cover Gasket Set

Application	Part #	List Price
3.4/3.8/4.2L	C4544-060	\$7.02

Water Pump Gasket

Application	Part #	List Price
3.4/3.8/E4.2L .018" AFM	C4337-018	\$5.99



Cometic Gasket - An Exclusive NASCAR Performance Product

JAGUAR

4.2L Inline 6 68-70 E-Type Series 2, 68-73 XJ6 4.2 Series 1

Head Gaskets

CFM-20 Head Gasket				
Bore	Thickness	Pkg Qty	Part #	List Price
93mm	.059"	1	C4220-059	\$128.68

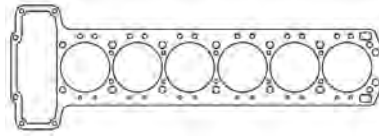

Additional thicknesses available see page 4

Individual Gaskets

Cam Cover Gasket Set		
Application	Part #	List Price
3.4/3.8/4.2L (Trim to Fit)	C4545-060	\$42.07

Oil Pan Gasket		
Application	Part #	List Price
3.4/3.8/4.2L .060" AFM	C4259-060	\$23.35

Intake Manifold Gaskets		
Application	Part #	List Price
3.8/4.2L Str Port Head	C4230-060	\$17.67
3.4/3.8L B Type Head	C4244-060	\$17.67

Engine Cover Gaskets		
Application	Part #	List Price
Front Main Seal Gasket	C4902-018	\$19.03
Rear Main Seal Gasket	C4901-188	\$3.19

Exhaust Manifold Gasket		
Application	Part #	List Price
3.4/3.8/4.2L	C4217-059	\$10.76

Timing Cover Gasket		
Application	Part #	List Price
3.4/3.8/E4.2L .018" AFM	C4336-018	\$19.03
4.2L 1970+Up .018" AFM	C4902-018	\$19.03

Thermostat Gaskets		
Application	Part #	List Price
Series 1 1965-67	C4375-060	\$2.33
Series 2 1968-71	C4379-060	\$2.33

Engine Oil Gaskets		
Application	Part #	List Price
Oil Feed Gasket	C4949-032	\$2.33
Oil Filter Housing Gasket	C4179-032	\$3.51

Breather Cover Gasket Set		
Application	Part #	List Price
3.4/3.8/4.2L	C4544-060	\$7.02

Water Pump Gasket		
Application	Part #	List Price
3.4/3.8/E4.2L .018" AFM	C4337-018	\$5.99
4.2L 1970+Up .018" AFM	C4903-018	\$4.69

4.2L Hi-Performance Inline 6 1973-87 XJ6 4.2 Series 3

Head Gaskets

MLS Head Gaskets				
Bore	Thickness	Pkg Qty	Part #	List Price
3.670"	.040"	1	C4128-040	\$222.15
3.690"	.040"	1	C4127-040	\$222.15

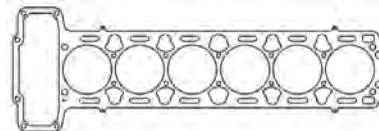

Additional thicknesses available see page 4

Individual Gaskets

Cam Cover Gasket Set		
Application	Part #	List Price
3.4/3.8/4.2L (Trim to Fit)	C4545-060	\$42.07

Oil Pan Gasket		
Application	Part #	List Price
3.4/3.8/4.2L .060" AFM	C4259-060	\$23.35

Intake Manifold Gaskets		
Application	Part #	List Price
3.8/4.2L Str Port Head	C4230-060	\$17.67
3.4/3.8L B Type Head	C4244-060	\$17.67

Engine Cover Gaskets		
Application	Part #	List Price
Rear Main Seal Gasket	C4901-188	\$3.19
Front Main Seal Gasket	C4902-018	\$19.03



Cometic Gasket - An Exclusive NASCAR Performance Product

JAGUAR

4.2L Hi-Performance Inline 6 1973-87 XJ6 4.2 Series 3

Individual Gaskets

Exhaust Manifold Gasket

Application	Part #	List Price
3.4/3.8/4.2L.....	C4217-059	\$10.76

Timing Cover Gasket

Application	Part #	List Price
4.2L 1970+Up .018" AFM	C4902-018	\$19.03

Thermostat Gaskets

Application	Part #	List Price
Series 1 1965-67	C4375-060	\$2.33
Series 2 1968-71	C4379-060	\$2.33

Engine Oil Gaskets

Application	Part #	List Price
Oil Feed Gasket.....	C4949-032	\$2.33
Oil Filter Housing Gasket.....	C4179-032	\$3.51

Breather Cover Gasket Set

Application	Part #	List Price
3.4/3.8/4.2L.....	C4544-060	\$7.02

Water Pump Gasket

Application	Part #	List Price
4.2L 1970+Up .018" AFM	C4903-018	\$4.69

5.0L V8 AJ133 2009+Up XF, XJ, XK, XFR, XJR, XKR, 2011+Up XKR-S, 2013+Up XFR-S, F-Type Convertible, 2014+Up F-Type Coupe

Head Gaskets

MLX Head Gasket - Left Side

Bore	Thickness	Pkg Qty	Part #	List Price
93mm	.040"	1	C15001-040	\$103.16

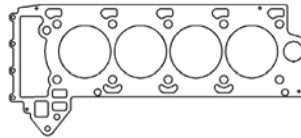

Additional thicknesses available see page 4

MLX Head Gasket - Right Side

Bore	Thickness	Pkg Qty	Part #	List Price
93mm	.040"	1	C15000-040	\$103.16

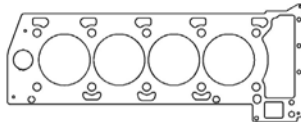

Additional thicknesses available see page 4

5.3L V12 1971-93

Head Gaskets

CFM-20 Head Gaskets - Left Side

Bore	Thickness	Pkg Qty	Part #	List Price
93mm	.059"	1	C4330-059	\$128.68
97mm	.059"	1	C4221-059	\$128.68

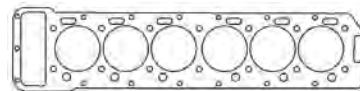

Additional thicknesses available see page 4

CFM-20 Head Gaskets - Right Side

Bore	Thickness	Pkg Qty	Part #	List Price
93mm	.059"	1	C4331-059	\$128.68
97mm	.059"	1	C4222-059	\$128.68

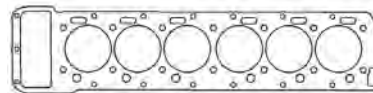

Additional thicknesses available see page 4

MAZDA

B6 1.6L DOHC 16V 1989-93 1597cc

Head Gaskets

MLS Head Gasket

Bore	Thickness	Pkg Qty	Part #	List Price
80mm	.040"	1	C4122-040	\$105.21

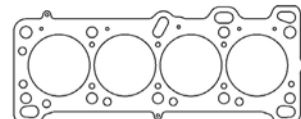

Additional thicknesses available see page 4



Cometic Gasket - An Exclusive NASCAR Performance Product

MAZDA

B6 1.6L DOHC 16V 1989-93 1597cc

Individual Gaskets

Valve Cover Gasket Set		
Application	Part #	List Price
B6 1.6L 89-93	C4781	\$28.31

Rear Main Seal Set		
Application	Part #	List Price
B6 1.6L 89-93	C4783	\$12.76

Intake Manifold Gasket		
Application	Part #	List Price
B6 1.6L 89-93 .060" KF	C4779-060	\$11.94

Oil Pump Gasket Set		
Application	Part #	List Price
B6 1.6L 89-93	C4784	\$3.29

Exhaust Manifold Gasket		
Application	Part #	List Price
B6 1.6L 89-93 .030" MLS	C4165-030	\$32.36

Oil Pan Gasket Set		
Application	Part #	List Price
B6 1.6L 89-93 (Requires RTV)	C4785	\$10.60

Cam Seal Set		
Application	Part #	List Price
B6 1.6L 89-93 (2 Pack)	C4780	\$8.32

Water Pump Gasket		
Application	Part #	List Price
B6 1.6L 89-93	C4786	\$4.68

Valve Stem Seals (sold individually)		
Application	Part #	List Price
B6 1.6L 89-93	3169V	\$1.58

Thermostat Gasket		
Application	Part #	List Price
B6 1.6L 89-93 .046" Fiber	C4782-046	\$2.76

Gasket Kits



To purchase a complete gasket kit order both top end and bottom end gasket kit

TOP END GASKET KIT



Application	Part #	List Price
B6 1.6L 89-93 80mm Bore	PRO2036T	\$174.77

BOTTOM END GASKET KIT



Application	Part #	List Price
B6 1.6L 89-93	PRO2036B	\$88.45

BP 1.8L DOHC 16V 1994-97 1839cc

Head Gaskets

MLS Head Gaskets				
Bore	Thickness	Pkg Qty	Part #	List Price
83mm	.040"	1	C4560-040	\$105.21
84mm	.040"	1	C4568-040	\$105.21
85mm	.040"	1	C4569-040	\$105.21

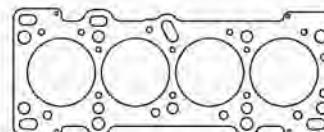

Additional thicknesses available see page 4



Cometic Gasket - An Exclusive NASCAR Performance Product

MAZDA

BP 1.8L DOHC 16V 2001-05 1839cc

Head Gaskets

NEW!

MLS Head Gaskets

Bore	Thickness	Pkg Qty	Part #	List Price
84mm	.040"	1	C4983-040	\$105.21
85mm	.040"	1	C4984-040	\$105.21

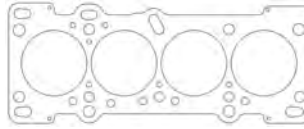

Additional thicknesses available see page 4

FS-DE 2.0L DOHC 16V 1993-03 1991cc

Head Gaskets

MLS Head Gaskets

Bore	Thickness	Pkg Qty	Part #	List Price
84mm	.030"	1	C5844-030	\$110.44
84.5mm	.027"	1	C5845-027	\$110.44

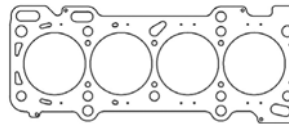

Additional thicknesses available see page 4

Individual Gaskets

Valve Cover Gasket Set

Application	Part #	List Price
FS-DE 2.0L DOHC	C4788	\$28.31

Oil Pan Gasket Set

Application	Part #	List Price
FS-DE 2.0L DOHC	C4790-062	\$4.86

Intake Manifold Gasket

Application	Part #	List Price
FS-DE 2.0L DOHC	C4787-046	\$10.46

Rear Main Seal Set

Application	Part #	List Price
FS-DE 2.0L DOHC	C4791	\$24.28

Exhaust Manifold Gasket

Application	Part #	List Price
FS-DE 2.0L DOHC .030" MLS	C4171-030	\$26.99

Water Pump Gasket

Application	Part #	List Price
FS-DE 2.0L DOHC	C4792-031	\$2.43

Cam Seal Set

Application	Part #	List Price
FS-DE 2.0L DOHC (2 Pack)	C4780	\$8.32

Thermostat Gasket

Application	Part #	List Price
FS-DE 2.0L DOHC	C4789	\$9.55

Valve Stem Seals (sold individually)

Application	Part #	List Price
FS-DE 2.0L DOHC	3225V	\$1.68

Gasket Kits



To purchase a complete gasket kit order both top end and bottom end gasket kit

TOP END GASKET KIT



Application	Part #	List Price
FS-DE 2.0L DOHC 93-03 84mm Bore	PRO2037T	\$163.84

BOTTOM END GASKET KIT



Application	Part #	List Price
FS-DE 2.0L DOHC 93-03	PRO2037B	\$40.38



Cometic Gasket - An Exclusive NASCAR Performance Product

MAZDA

MZR 2.3L DOHC 16V 2261cc 2006-08

Head Gasket

MLS Head Gasket				
Bore	Thickness	Pkg Qty	Part #	List Price
89mm030"1	C4481-030\$98.23

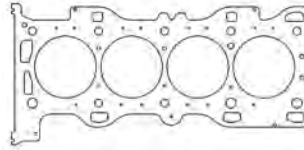

Additional thicknesses available see page 4

NEW!

MLX Head Gasket				
Bore	Thickness	Pkg Qty	Part #	List Price
89mm028"1	C4970-028\$136.33

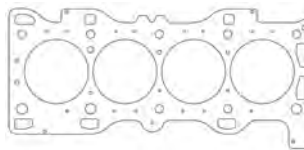

MZR 2.5L DISI DOHC 16V 2488cc 2009

Head Gasket

MLS Head Gasket				
Bore	Thickness	Pkg Qty	Part #	List Price
90mm040"1	C5906-040\$98.23

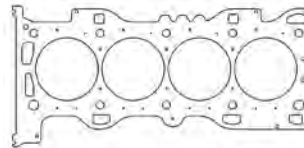

Additional thicknesses available see page 4

MERCEDES BENZ

M120 6.0/7.0L V12 1992 600SEC, 600SEL, 600SL, 1997 CLK-GTR

Head Gaskets

MLS Head Gasket - Left Side				
Bore	Thickness	Pkg Qty	Part #	List Price
90mm051"1	C4501-051\$334.41

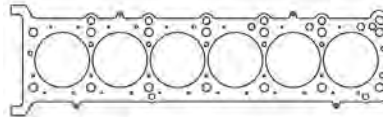

Additional thicknesses available see page 4

MLS Head Gasket - Right Side				
Bore	Thickness	Pkg Qty	Part #	List Price
90mm051"1	C4500-051\$334.41

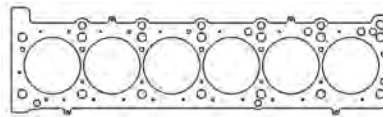

Additional thicknesses available see page 4

M120 7.3L V12 99-05 Pagani Zonda, 99-05 AMG SL73

Head Gaskets

MLS Head Gasket - Left Side				
Bore	Thickness	Pkg Qty	Part #	List Price
91.5mm051"1	C4504-051\$334.41

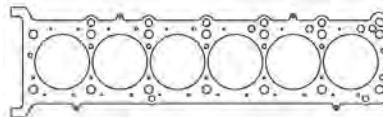

Additional thicknesses available see page 4

MLS Head Gasket - Right Side				
Bore	Thickness	Pkg Qty	Part #	List Price
91.5mm051"1	C4503-051\$334.41

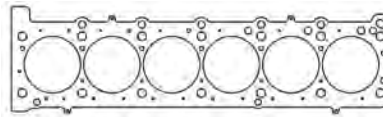

Additional thicknesses available see page 4



Cometic Gasket - An Exclusive NASCAR Performance Product

MG

Midget 1275cc Austin Series A

Head Gasket

MLS Head Gasket

Bore	Thickness	Pkg Qty	Part #	List Price
74mm040"1	C4148-040\$93.53

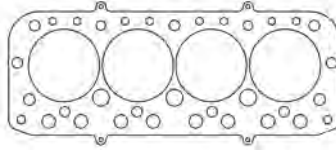

Additional thicknesses available see page 4

MGA1500/1600/1600 MKII Series B

Head Gasket

MLS Head Gasket

Bore	Thickness	Pkg Qty	Part #	List Price
74mm040"1	C4359-040\$93.53

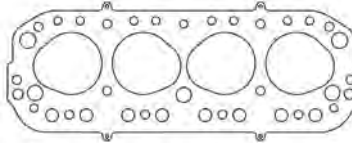

Additional thicknesses available see page 4

MGB 1.8L 18G/18GA

Head Gasket

MLS Head Gasket

Bore	Thickness	Pkg Qty	Part #	List Price
83mm040"1	C4147-040\$93.53

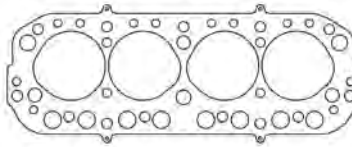

Additional thicknesses available see page 4

MINI

1.6L Tritec/Pentagon 1999-06

Head Gasket

MLS Head Gasket

Bore	Thickness	Pkg Qty	Part #	List Price
78.5mm027"1	C4308-027\$93.53

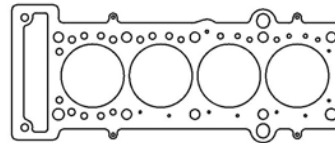

Additional thicknesses available see page 4

1.6L Turbo Prince/N14B16C/N14B16A 07-13

Head Gasket

NEW!

MLX Head Gasket

Bore	Thickness	Pkg Qty	Part #	List Price
78mm032"1	C4617-032\$93.53
78mm036"1	C4617-036\$93.53
78mm040"1	C4617-040\$93.53

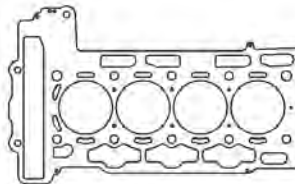

Additional thicknesses available see page 4



Cometic Gasket - An Exclusive NASCAR Performance Product

MITSUBISHI

2.0L 4G63/4G63-T DOHC Eclipse 90-99, Galant 89-92, EVO 1-3 92-95

Head Gaskets

MLS Head Gaskets

Bore	Thickness	Pkg Qty	Part #	List Price
85.5mm	.051"	1	C4233-051	\$93.53
86mm	.051"	1	C4234-051	\$93.53
87mm	.051"	1	C4235-051	\$93.53

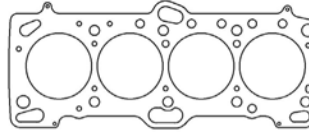

Additional thicknesses available see page 4

MLX Head Gasket

Bore	Thickness	Pkg Qty	Part #	List Price
87mm	.050"	1	C4957-050	\$115.84

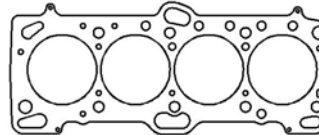

Additional thicknesses available see page 4

Individual Gaskets

Valve Cover Gasket Set

Application	Part #	List Price
4G63/T 89-94	C4691	\$38.51

Throttle Body Gaskets

Application	Part #	List Price
4G63/T 91-94	C4693	\$5.73
4G63/T 95-97	C4904	\$5.73

Intake Manifold Gasket

Application	Part #	List Price
4G63/T 89-94	C4692-060	\$15.94

Oil Pan Gaskets

Application	Part #	List Price
4G63/T 89-92	C4695	\$14.73
4G63/T 93-94	C4698	\$6.33

Exhaust Manifold Gasket

Application	Part #	List Price
4G63/T 89-94 .030" MLS	C4199-030	\$23.74

Water Pump Gasket Set

Application	Part #	List Price
4G63/T 89-94	C4696	\$10.99

Cam Seal Set

Application	Part #	List Price
4G63/T 89-94 (2 Pack)	C4905	\$20.85

Rear Main Seal Set

Application	Part #	List Price
4G63/T 89-92	C4697	\$23.25
4G63/T 93-94	C4699	\$13.07

Valve Stem Seals (sold individually)

Application	Part #	List Price
4G63/T 89-94	3173V	\$2.00

Thermostat Gasket Set

Application	Part #	List Price
4G63/T 89-94	C4694	\$11.99

Gasket Kits



To purchase a complete gasket kit order both top end and bottom end gasket kit

TOP END GASKET KIT

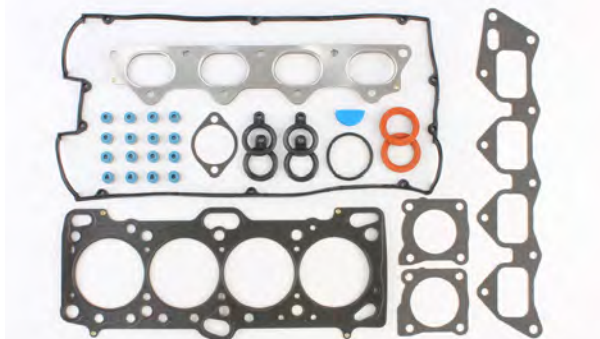

Application	Part #	List Price
4G63/T 89-94 84mm Bore	PRO2006T	\$196.83

BOTTOM END GASKET KITS

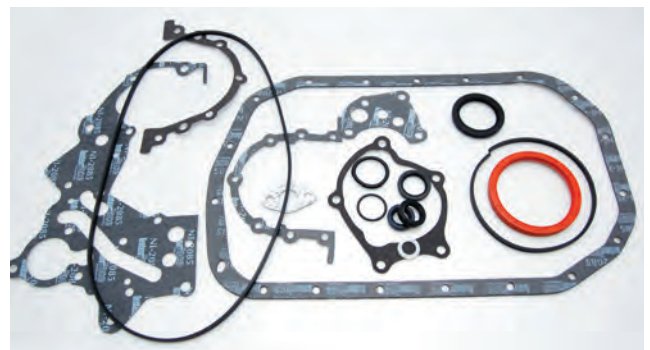

Application	Part #	List Price
4G63/T 89-92	PRO2006B	\$81.90
4G63/T 93-94	PRO2007B	\$51.30



Cometic Gasket - An Exclusive NASCAR Performance Product

MITSUBISHI

2.0L 4G63/4G63-T DOHC:EVO 4-8 96-05

Head Gaskets

MLS Head Gaskets

Bore	Thickness	Pkg Qty	Part #	List Price
85mm	.051"	1	C4157-051	\$93.53
86mm	.051"	1	C4156-051	\$93.53
87mm	.051"	1	C4591-051	\$93.53

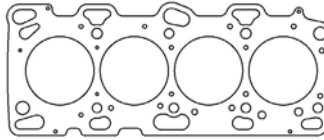

Additional thicknesses available see page 4

NEW!

MLX Head Gasket

Bore	Thickness	Pkg Qty	Part #	List Price
87mm	.032"	1	C4956-050	\$115.84
87mm	.044"	1	C4956-050	\$115.84
87mm	.050"	1	C4956-050	\$115.84

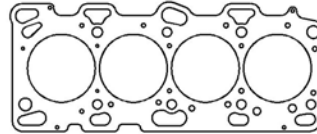

Additional thicknesses available see page 4

2.0L DOHC 4cyl ECC/420A 1995-99

Head Gaskets

MLS Head Gaskets

Bore	Thickness	Pkg Qty	Part #	List Price
87.5mm	.040"	1	C5497-040	\$89.49
88.5mm	.040"	1	C5498-040	\$89.49

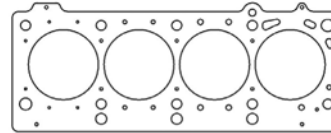

Additional thicknesses available see page 4

Individual Gaskets

Valve Cover Gasket Set

Application	Part #	List Price
1995-99 2.0L DOHC	C15046	\$22.65

Cam Seal Set

Application	Part #	List Price
Pair - 48 x 35 x 7	C15049	\$13.42

Intake Manifold Gaskets

Application	Part #	List Price
Intake Manifold Gasket - .060" AFM	C15047-060	\$11.41
Intake Plenum Gasket - .031" Fiber	C15048-031	\$4.71

Front Crank Seal Set

Application	Part #	List Price
1995-99 2.0L DOHC	C15053	\$20.59

Exhaust Manifold Gasket

Application	Part #	List Price
2.040" X 1.100" Port - MLS	C4161-030	\$23.74

Oil Pan Gasket

Application	Part #	List Price
Molded Rubber	C15050	\$28.55

Throttle Body Gasket

Application	Part #	List Price
Molded Rubber	C15051	\$3.61

Rear Main Seal

Application	Part #	List Price
1995-99 2.0L DOHC	C15052	\$13.14

Valve Stem Seals Set (16 Pack)

Application	Part #	List Price
5 x 10.8 x 18.3 x 16.9 - Hat Style	3180V-16	\$32.49

See page 103 for StreetPro gasket kits



Cometic Gasket - An Exclusive NASCAR Performance Product

MITSUBISHI

2.0L DOHC 4cyl ECC/420A 1995-99

Gasket Kits



To purchase a complete gasket kit order both top end and bottom end gasket kit

TOP END GASKET KIT

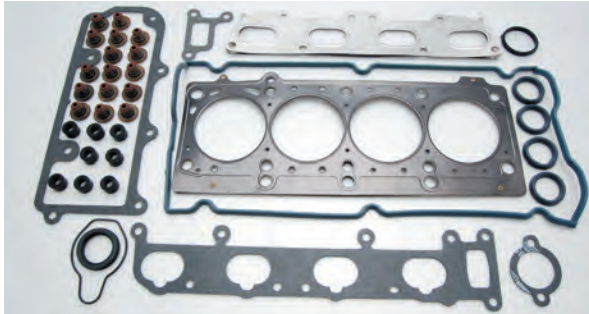

Application	Part #	List Price
1995-99 420A 2.0L DOHC 88.5mm Bore	PRO2005T	\$152.91

BOTTOM END GASKET KIT

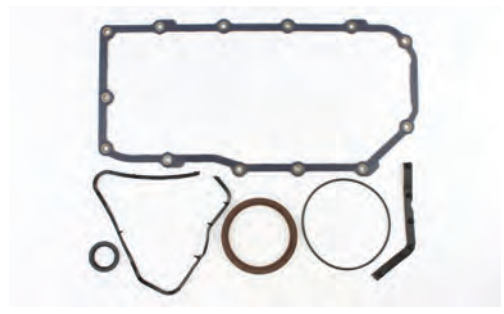

Application	Part #	List Price
1995-99 420A 2.0L DOHC.....	PRO2005B	\$73.15

2.0L 4B11T Turbo 2007+: EVO X 2007-15

Head Gaskets

MLX Head Gaskets

Bore	Thickness	Pkg Qty	Part #	List Price
88mm044"	1.....	C4483-044	\$115.84
90mm044"	1.....	C4484-044	\$115.84

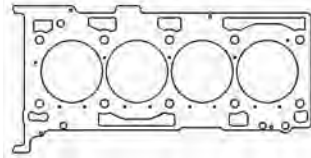

Additional thicknesses available see page 4

3.0L 6G72 SOHC/DOHC 24v V6 1988-00

Head Gaskets

MLS Head Gaskets

Bore	Thickness	Pkg Qty	Part #	List Price
93mm051"	1.....	C4243-051	\$93.53
95mm051"	1.....	C4240-051	\$93.53

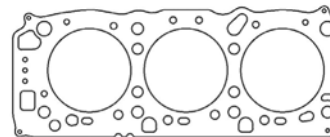

Additional thicknesses available see page 4

Individual Gaskets

Valve Cover Gasket Sets

Application	Part #	List Price
1988-96 3.0L V6 SOHC.....	C4713	\$28.31
1991-00 3.0L V6 DOHC	C4722	\$5.31

Oil Pan Gaskets

Application	Part #	List Price
1988-96 3.0L V6 SOHC.....	C4717	\$5.29
1991-00 3.0L V6 DOHC	C4727	\$5.14

Intake Manifold Gasket Sets

Application	Part #	List Price
1988-96 3.0L V6 SOHC.....	C4714	\$27.35
1991-00 3.0L V6 DOHC	C4723	\$48.53

Water Pump Gasket Sets

Application	Part #	List Price
1988-96 3.0L V6 SOHC.....	C4719	\$10.12
1991-00 3.0L V6 DOHC	C4728-020	\$4.76

Exhaust Manifold Gasket Sets

Application	Part #	List Price
1988-96 3.0L V6 SOHC.....	C4715-042	\$51.40
1991-00 3.0L V6 DOHC	C4724-064	\$51.40

Rear Main Seal Set

Application	Part #	List Price
1988-00 3.0L V6 SOHC/DOHC	C4720	\$14.60

See page 104 for additional gaskets



Cometic Gasket - An Exclusive NASCAR Performance Product

MITSUBISHI

3.0L 6G72 SOHC/DOHC 24v V6 1988-00

Individual Gaskets

Cam Seal Sets

Application	Part #	List Price
1988-96 3.0L V6 SOHC (2)	C4905	\$20.85
1991-00 3.0L V6 DOHC (4)	C4725	\$18.17

Oil Pump Gasket Kits

Application	Part #	List Price
1988-96 3.0L V6 SOHC	C4721	\$7.01
1991-00 3.0L V6 DOHC	C4729	\$8.05

Valve Stem Seals (sold individually)

Application	Part #	List Price
1988-96 3.0L V6 SOHC	3157V	\$1.79
1991-00 3.0L V6 DOHC	3163V	\$2.33

Thermostat Gaskets

Application	Part #	List Price
1988-96 3.0L V6 SOHC	C4716-032	\$7.01
1991-00 3.0L V6 DOHC	C4726	\$2.76

Gasket Kits



To purchase a complete gasket kit order both top end and bottom end gasket kit

TOP END GASKET KITS



Application	Part #	List Price
1988-96 3.0L V6 SOHC 93mm Bore	PRO2038T	\$285.12
1991-00 3.0L V6 DOHC 93mm Bore	PRO2039T	\$402.03

BOTTOM END GASKET KITS



Application	Part #	List Price
1988-96 3.0L V6 SOHC	PRO2038B	\$43.65
1991-00 3.0L V6 DOHC	PRO2039B	\$35.30

NISSAN

1.5L E15, E15S, E15T SOHC Pulsar 80-86, Ninja Gayin 84-94, Sunny 80-86

Head Gasket

MLS Head Gasket

Bore	Thickness	Pkg Qty	Part #	List Price
77.5mm	.040"	1	C4178-040	\$93.53

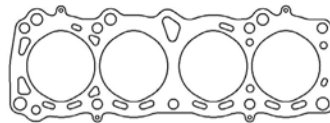

Additional thicknesses available
see page 4

Individual Gaskets

Valve Cover Gasket Set

Application	Part #	List Price
E15T 1983-84	C4906	\$16.98

Cam Seal

Application	Part #	List Price
E15T 1983-84	C4910	\$4.38

Intake Manifold Gasket

Application	Part #	List Price
E15T 1983-84	C4907	\$10.86

Rear Main Seal Set

Application	Part #	List Price
E15T 1983-84	C4763	\$14.01

See page 105 for additional gaskets



Cometic Gasket - An Exclusive NASCAR Performance Product

NISSAN

1.5L E15, E15S, E15T SOHC Pulsar 80-86, Ninja Gayin 84-94, Sunny 80-86

Individual Gaskets

Exhaust Manifold Gaskets		
Application	Part #	List Price
1982-83 E15S SOHC	C4908	\$13.23
1983-84 E15T SOHC	C4909	\$24.24

Front Crank Set		
Application	Part #	List Price
E15T 1983-84	C4912	\$29.19

Valve Stem Seals (sold individually)		
Application	Part #	List Price
E15T 1983-84	3159V	\$1.33

Water Pump Gasket Set		
Application	Part #	List Price
E15T 1983-84	C4913	\$2.25

1.6L MR16DDT Juke 2011-2017, 2017-Present Sentra SR Turbo & NISMO

Head Gasket

MLS Head Gasket				
Bore	Thickness	Pkg Qty	Part #	List Price
81mm032"	1	C4965-032	\$115.84



Additional thicknesses available see page 4

1.8L CA18 SOHC

Skyline R31 88-90, Skyline R32 GXi 88-90, Skyline HR31 85-91, Silvia Turbo 84-89, 180SX 81-83, 200SX 84-88, Bluebird Turbo 91-93, Bluebird 83-85, 200SX Turbo 84-87, Pulsar 81-83, Sunny 88-91

Head Gaskets

MLS Head Gasket				
Bore	Thickness	Pkg Qty	Part #	List Price
85mm051"	1	C4479-051	\$108.40

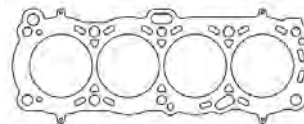

Additional thicknesses available see page 4

1.8L CA18 DOHC

Skyline HR31 85-91, Silvia Turbo 89-90, 180SX P/S13 89-90, 200SX S13-U 89-93, Bluebird Turbo 87-89, Bluebird 87-89, 200SX Turbo 89-93, Pulsar, Sunny N13/B12 Coupe mid 80s

Head Gaskets

MLS Head Gasket				
Bore	Thickness	Pkg Qty	Part #	List Price
85mm051"	1	C4480-051	\$108.40

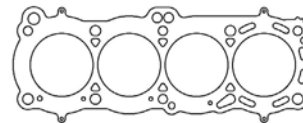

Additional thicknesses available see page 4

Individual Gaskets

Valve Cover Gasket Set		
Application	Part #	List Price
CA18DE/DET 1.8L.....	C4607	\$222.65

Throttle Body Gaskets		
Application	Part #	List Price
CA18DE/DET 1.8L (pair)	C4740-032	\$5.94

Intake Manifold Gasket Set		
Application	Part #	List Price
CA18DE/DET 1.8L.....	C4742	\$34.00

Rear Main Seal Set		
Application	Part #	List Price
CA18DE/DET 1.8L.....	C4737	\$16.22

Exhaust Manifold Gasket Set		
Application	Part #	List Price
CA18DE/DET 1.8L MLS 4pcs.....	C4523	\$33.52

Water Pump Gasket		
Application	Part #	List Price
CA18DE/DET 1.8L.....	C4736-018	\$6.05

See page 106 for additional gaskets



Cometic Gasket - An Exclusive NASCAR Performance Product

NISSAN

1.8L CA18 DOHC

Skyline HR31 85-91, Silvia Turbo 89-90, 180SX P/S13 89-90, 200SX S13-U 89-93, Bluebird Turbo 87-89, Bluebird 87-89, 200SX Turbo 89-93, Pulsar, Sunny N13/B12 Coupe mid 80s

Individual Gaskets

Cam Seal Set

Application	Part #	List Price
CA18DE/DET 1.8L (pair)	C4739	\$8.86

Oil Pump Gasket

Application	Part #	List Price
CA18DE/DET 1.8L	C4738-020	\$4.92

Valve Stem Seals (sold individually)

Application	Part #	List Price
CA18DE/DET 1.8L	3175V	\$1.41

Front Crank Seal

Application	Part #	List Price
CA18DE/DET 1.8L	C4914	\$4.43

Gasket Kits



To purchase a complete gasket kit order both top end and bottom end gasket kit

TOP END GASKET KIT



Application	Part #	List Price
CA18DE/DET 1.8L 85mm Bore	PRO2018T	\$216.29

BOTTOM END GASKET KIT



Application	Part #	List Price
CA18DE/DET 1.8L	PRO2018B	\$46.62

2.0L FJ20E/ET 240RS 83-85, Skyline DR30 83-85, Silvia 83-85

Head Gaskets

MLS Head Gaskets

Bore	Thickness	Pkg Qty	Part #	List Price
90mm	.051"	1	C4326-051	\$105.21
91mm	.051"	1	C4327-051	\$105.21

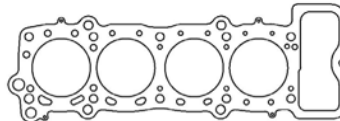

Additional thicknesses available see page 4

1.6L SR16VE/2.0L SR20VE DOHC 97-01 Pulsar, Lucino, Primera, Bluebird, Wingroad, Sunny

Head Gasket

MLS Head Gaskets

Bore	Thickness	Pkg Qty	Part #	List Price
87mm	.040"	1	C4600-040	\$93.53
88mm	.040"	1	C4601-040	\$93.53

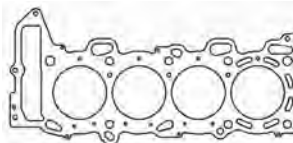

Additional thicknesses available see page 4

Individual Gaskets

Valve Cover Gasket Set

Application	Part #	List Price
SR16VE/SR20VE	C4730	\$39.64

Throttle Body Gasket

Application	Part #	List Price
SR16VE/SR20VE	C4733-018	\$2.97

See page 107 for additional gaskets



Cometic Gasket - An Exclusive NASCAR Performance Product

NISSAN

1.6L SR16VE/2.0L SR20VE DOHC 97-01 Pulsar, Lucino, Primera, Bluebird, Wingroad, Sunny

Individual Gaskets

Intake Manifold Gasket Set		
Application	Part #	List Price
SR16VE/SR20VE	C4731	\$33.97

Rear Main Seal		
Application	Part #	List Price
SR16VE/SR20VE	C4734	\$12.76

Exhaust Manifold Gasket Set		
Application	Part #	List Price
SR16VE/SR20VE	C4732-064	\$12.97

Oil Pump Gasket		
Application	Part #	List Price
SR16VE/SR20VE	C4735-020	\$1.04

Valve Stem Seals (sold individually)		
Application	Part #	List Price
SR16VE/SR20VE	3175V	\$1.41

Front Crank Seal		
Application	Part #	List Price
SR16VE/SR20VE	C4915	\$5.30

Gasket Kits

To purchase a complete gasket kit order both top end and bottom end gasket kit

TOP END GASKET KIT

Application	Part #	List Price
SR16VE/SR20VE 88mm Bore	PRO2053T	\$214.10

BOTTOM END GASKET KIT

Application	Part #	List Price
SR16VE/SR20VE	PRO2053B	\$32.02

2.0L SR20DE/DET DOHC FWD

91-92/94-97 180SX, 95-98 200SX SE-R, 96-98 Almera, 90/92-95/97-01 Avenir, 89/91-93/95-98 Bluebird, 98-00 Liberty, 91-02 Infinity G20, 91-93 NX2000, 91-00 Pulsar, 91-94/98-01 Sentra

Head Gaskets

MLS Head Gaskets				
Bore	Thickness	Pkg Qty	Part #	List Price
87mm030"	1	C4575-030	\$93.53
88.5mm030"	1	C4130-030	\$93.53



Additional thicknesses available see page 4

Individual Gaskets

Valve Cover Gasket Sets		
Application	Part #	List Price
SR20DE/DET FWD 91-96	C4747	\$28.31
SR20DE/DET FWD 97-01	C4730	\$39.64

Thermostat Gasket Set		
Application	Part #	List Price
SR20DE/DET FWD 91-01	C4916	\$6.22

See page 108 for additional gaskets



Cometic Gasket - An Exclusive NASCAR Performance Product

NISSAN

2.0L SR20DE/DET DOHC FWD

91-92/94-97 180SX, 95-98 200SX SE-R, 96-98 Almera, 90/92-95/97-01 Avenir, 89/91-93/95-98 Bluebird, 98-00 Liberty, 91-02 Infinity G20, 91-93 NX2000, 91-00 Pulsar, 91-94/98-01 Sentra

Individual Gaskets

Intake Manifold Gaskets

Application	Part #	List Price
SR20DE/DET FWD 91-93	C4746	\$7.57
SR20DE/DET FWD 94-01	C4749	\$20.09

Oil Pan Gasket

Application	Part #	List Price
SR20DE/DET FWD 91-01	C4744-156	\$23.30

Exhaust Manifold Gasket Set

Application	Part #	List Price
SR20DE/DET FWD 91-01 MLS	C4200-030	\$29.15

Water Pump Gasket

Application	Part #	List Price
SR20DE/DET FWD 91-01	C4745-031	\$3.20

Throttle Body Gasket

Application	Part #	List Price
SR20DE/DET FWD 91-01	C4733-018	\$2.97

Oil Pump Gasket

Application	Part #	List Price
SR20DE/DET FWD 91-01	C4743	\$15.14

Valve Stem Seals (sold individually)

Application	Part #	List Price
SR20DE/DET FWD 91-01	3175V	\$1.41

Front Crank Seal

Application	Part #	List Price
SR20DE/DET FWD 91-01	C4915	\$5.30

Gasket Kits



To purchase a complete gasket kit order both top end and bottom end gasket kit

TOP END GASKET KIT



Application	Part #	List Price
SR20DE/DET FWD 91-96 87mm Bore	PRO2012T	\$185.69
SR20DE/DET FWD 97-01 87mm Bore	PRO2011T	\$185.69

BOTTOM END GASKET KIT



Application	Part #	List Price
SR20DE/DET FWD 91-01	PRO2012B	\$51.30

2.0L SR20DE/DET DOHC S13 1989-93

Head Gasket

MLS Head Gasket

Bore	Thickness	Pkg Qty	Part #	List Price
87.5mm	.045"	1	C4324-045	\$93.53



Additional thicknesses available see page 4

See page 109 for additional gaskets



Cometic Gasket - An Exclusive NASCAR Performance Product

NISSAN

Syspro shows SR16VE

2.0L SR20DE/DET DOHC S13 1989-93

Individual Gaskets

Valve Cover Gasket Set		
Application	Part #	List Price
SR20DE/DET S13 89-93	C4753	\$22.65

Throttle Body Gasket		
Application	Part #	List Price
SR20DE/DET S13 89-93	C4733-018	\$2.97

Intake Manifold Gasket Set		
Application	Part #	List Price
SR20DE/DET S13 89-93	C4752	\$13.16

Thermostat Gasket Set		
Application	Part #	List Price
SR20DE/DET S13 89-93	C4758	\$4.06

Exhaust Manifold Gasket Set		
Application	Part #	List Price
SR20DE/DET S13 89-93 MLS	C4200-030	\$29.15

Rear Main Seal Set		
Application	Part #	List Price
SR20DE/DET S13 89-93	C4743	\$15.14

Valve Stem Seals (sold individually)		
Application	Part #	List Price
SR20DE/DET S13 - EXH	3158V	\$1.33
SR20DE/DET S13 - INT	3175V	\$1.41

Front Crank Seal		
Application	Part #	List Price
SR20DE/DET S13 89-93	C4915	\$5.30

Gasket Kits

To purchase a complete gasket kit order both top end and bottom end gasket kit

TOP END GASKET KIT



Application	Part #	List Price
SR20DE/DET S13 w/o VC Set 87.5mm Bore ..	PRO2008T	\$185.69
SR20DE/DET S13 89-93 88mm Bore	PRO2053T	\$214.10

BOTTOM END GASKET KIT



Application	Part #	List Price
SR20DE/DET S13 89-93	PRO2010B	\$51.30

2.0L SR20DE/DET DOHC S14 1994-98

Head Gaskets

MLS Head Gaskets				
Bore	Thickness	Pkg Qty	Part #	List Price
87.5mm045"	1	C4576-045	\$93.53
88.5mm045"	1	C4283-045	\$93.53

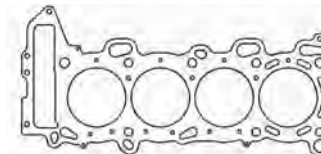

Additional thicknesses available see page 4

MLX Head Gaskets				
Bore	Thickness	Pkg Qty	Part #	List Price
87mm040"	1	C4950-040	\$119.98
88mm040"	1	C4951-040	\$119.98



See page 110 for additional gaskets



Cometic Gasket - An Exclusive NASCAR Performance Product

NISSAN

2.0L SR20DE/DET DOHC S14 1994-98

Individual Gaskets

Valve Cover Gasket Set		
Application	Part #	List Price
SR20DE/DET S14 94-98.....	C4755	\$22.65

Throttle Body Gasket		
Application	Part #	List Price
SR20DE/DET S14 94-98.....	C4754-032	\$3.19

Intake Manifold Gasket Set		
Application	Part #	List Price
SR20DE/DET S14 94-98.....	C4749	\$20.09

Thermostat Gasket Set		
Application	Part #	List Price
SR20DE/DET S14 94-98.....	C4758	\$4.06

Exhaust Manifold Gasket Set		
Application	Part #	List Price
SR20DE/DET S14 94-98 MLS	C4200-030	\$29.15

Rear Main Seal Set		
Application	Part #	List Price
SR20DE/DET S14 94-98.....	C4743	\$15.14

Valve Stem Seals (sold individually)		
Application	Part #	List Price
SR20DE/DET S14 - EXH	3158V	\$1.33
SR20DE/DET S14 - INT.....	3175V	\$1.41

Front Crank Seal		
Application	Part #	List Price
SR20DE/DET S14 94-98.....	C4915	\$5.30

Gasket Kit



To purchase a complete gasket kit order both top end and bottom end gasket kit

TOP END GASKET KIT



Application	Part #	List Price
SR20DE/DET S14 94-98 87.5mm Bore	PRO2009T	\$185.69

BOTTOM END GASKET KIT



Application	Part #	List Price
SR20DE/DET S14 94-98.....	PRO2010B	\$51.30

2.0L SR20DE/DET DOHC GTiR RNN14 AWD 1990-94

Head Gaskets

MLS Head Gaskets				
Bore	Thickness	Pkg Qty	Part #	List Price
87.5mm.....	.040".....	1.....	C4543-040	\$93.53
88mm.....	.040".....	1.....	C4577-040	\$93.53

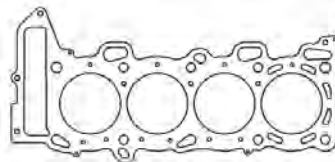

Additional thicknesses available see page 4

Individual Gaskets

Valve Cover Gasket Set		
Application	Part #	List Price
SR20DE/DET GTiR RNN14	C4747	\$27.49

Throttle Body Gasket		
Application	Part #	List Price
SR20DE/DET GTiR RNN14	C4756-018	\$11.13

See page 111 for additional gaskets



Cometic Gasket - An Exclusive NASCAR Performance Product

NISSAN

2.0L SR20DE/DET DOHC GTiR RNN14 AWD 1990-94

Individual Gaskets

Intake Manifold Gasket Set		
Application	Part #	List Price
SR20DE/DET GTiR RNN14	C4757-018	\$13.57

Thermostat Gasket Set		
Application	Part #	List Price
SR20DE/DET GTiR RNN14	C4758	\$4.06

Exhaust Manifold Gasket Set		
Application	Part #	List Price
SR20DE/DET GTiR RNN14 MLS	C4200-030	\$29.15

Rear Main Seal Set		
Application	Part #	List Price
SR20DE/DET GTiR RNN14	C4743	\$15.14

Valve Stem Seals (sold individually)		
Application	Part #	List Price
SR20DE/DET GTiR - EXH	3158V	\$1.33
SR20DE/DET GTiR - INT	3175V	\$1.41

Front Crank Seal		
Application	Part #	List Price
SR20DE/DET GTiR RNN14	C4915	\$5.30

Gasket Kits

To purchase a complete gasket kit order both top end and bottom end gasket kit

TOP END GASKET KIT



Application	Part #	List Price
SR20DE/DET GTiR RNN14 87.5mm Bore	PRO2010T	\$185.69

BOTTOM END GASKET KIT



Application	Part #	List Price
SR20DE/DET GTiR RNN14	PRO2010B	\$51.30

2.0L RB20E/DE/DET Inline 6 Laurel 1988-93, Skyline R32 1988-93, Cefiro 1988-93

Head Gaskets

MLS Head Gaskets				
Bore	Thickness	Pkg Qty	Part #	List Price
80mm040"	1	C4495-040	\$175.38

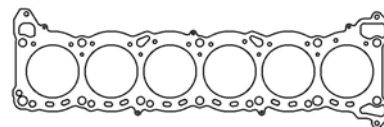

Additional thicknesses available see page 4

Individual Gaskets

Valve Cover Gasket Set		
Application	Part #	List Price
RB20E/DE/DET 88-93	C4552	\$33.98

Throttle Body Gasket		
Application	Part #	List Price
RB20E/DE/DET 88-93	C4733-018	\$2.97

Intake Manifold Gasket Set		
Application	Part #	List Price
RB20E/DE/DET 88-93	C4759	\$49.49

Rear Main Seal		
Application	Part #	List Price
RB20E/DE/DET 88-93	C4770	\$12.88

See page 112 for additional gaskets



Cometic Gasket - An Exclusive NASCAR Performance Product

NISSAN

2.0L RB20E/DE/DET Inline 6 Laurel 1988-93, Skyline R32 1988-93, Cefiro 1988-93

Individual Gaskets

Exhaust Manifold Gasket		
Application	Part #	List Price
RB20E/DE/DET 88-93 MLS	C4177-030	\$26.99

Oil Pump Gasket		
Application	Part #	List Price
RB20E/DE/DET 88-93	C4769-020	\$7.41

Cam Seal Set		
Application	Part #	List Price
RB20E/DE/DET 88-93 (pair)	C4739	\$8.86

Front Crank Seal		
Application	Part #	List Price
RB20E/DE/DET 88-93	C4914	\$4.43

Valve Stem Seals (sold individually)		
Application	Part #	List Price
RB20E/DE/DET 88-93	3175V	\$1.41

Gasket Kits



To purchase a complete gasket kit order both top end and bottom end gasket kit

TOP END GASKET KIT



Application	Part #	List Price
RB20E/DE/DET 88-93 80mm Bore	PRO2015T	\$245.79

BOTTOM END GASKET KIT



Application	Part #	List Price
RB20E/DE/DET 88-93	PRO2017B	\$51.30

2.4L KA24DE DOHC: 1991-98 240SX

Head Gaskets

MLS Head Gaskets

Bore	Thickness	Pkg Qty	Part #	List Price
90mm040"	1	C4285-040	\$93.53
91mm040"	1	C4286-040	\$93.53

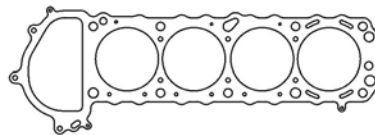

Additional thicknesses available see page 4

Individual Gaskets

Valve Cover Gasket Sets		
Application	Part #	List Price
KA24DE 1991-94	C4761	\$22.65
KA24DE 1995-98	C4766	\$22.65

Oil Pan Gasket		
Application	Part #	List Price
KA24DE 1991-98	C4764-060	\$12.33

Intake Manifold Gasket Set		
Application	Part #	List Price
KA24DE 1991-98	C4760	\$19.02

Water Pump Gasket		
Application	Part #	List Price
KA24DE 1991-98	C4765-031	\$3.24

See page 113 for additional gaskets



Cometic Gasket - An Exclusive NASCAR Performance Product

NISSAN

2.4L KA24DE DOHC: 1991-98 240SX

Individual Gaskets

Exhaust Manifold Gasket		
Application	Part #	List Price
KA24DE 1991-98 MLS	C4201-030	\$28.15

Rear Main Seal Set		
Application	Part #	List Price
KA24DE 1991-98	C4763	\$14.01

Throttle Body Gasket		
Application	Part #	List Price
KA24DE 1991-98	C4733-018	\$2.97

Thermostat Gasket Set		
Application	Part #	List Price
KA24DE 1991-98	C4762	\$3.81

Valve Stem Seals (sold individually)		
Application	Part #	List Price
KA24DE 1991-98	3158V	\$1.33

Front Crank Seal		
Application	Part #	List Price
KA24DE 1991-98	C4915	\$5.30

Gasket Kits

To purchase a complete gasket kit order both top end and bottom end gasket kit

TOP END GASKET KITS



Application	Part #	List Price
KA24DE 1991-94 90mm Bore	PRO2014T	\$141.99
KA24DE 1995-98 90mm Bore	PRO2013T	\$141.99

BOTTOM END GASKET KIT



Application	Part #	List Price
KA24DE 1991-98	PRO2014B	\$51.30

2.5L QR25DE DOHC 2002-06 FWD Sentra SE-R/SE-R Spec V, Altima Base/S/SL

Head Gasket

MLS Head Gasket				
Bore	Thickness	Pkg Qty	Part #	List Price
90mm030"	1	C4615-030	\$93.53

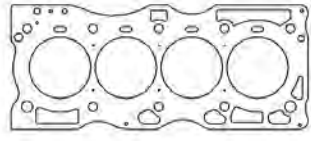

Additional thicknesses available see page 4

Individual Gaskets

Intake Manifold Gasket Set		
Application	Part #	List Price
QR25DE FWD 02-06	C4748	\$31.61

Throttle Body Gasket		
Application	Part #	List Price
QR25DE FWD 02-06	C4911	\$7.57



Cometic Gasket - An Exclusive NASCAR Performance Product

NISSAN

2.5L QR25DE DOHC 2007-12 FWD *Sentra SE-R/SE-R Spec V, Altima Base/S/Hybrid, Rogue S/SL/S Krom/SV*

Head Gasket

MLS Head Gasket

Bore	Thickness	Pkg Qty	Part #	List Price
90mm	.030"	1	C4614-030	\$93.53

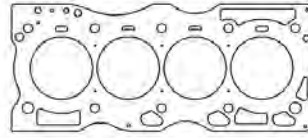

Additional thicknesses available
see page 4

Individual Gaskets

Water Inlet Gasket

Application	Part #	List Price
QR25DE FWD 07-12	C4751	\$4.72

Water Outlet Gasket

Application	Part #	List Price
QR25DE FWD 07-12	C4917	\$5.88

2.5L QR25DE DOHC 2005-12 RWD

05-10 Frontier XE, 08-10 Frontier SE, 05 X-Trail LE/SE/XE, 11-12 Frontier S/SV

Head Gasket

MLS Head Gasket

Bore	Thickness	Pkg Qty	Part #	List Price
90mm	.030"	1	C4616-030	\$93.53

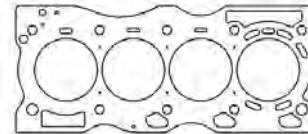

Additional thicknesses available
see page 4

Individual Gaskets

Water Outlet Gasket

Application	Part #	List Price
QR25DE RWD 05-12	C4918	\$5.88

Water Pump Gasket Set

Application	Part #	List Price
QR25DE RWD 05-12	C4919	\$21.07

L23, L24S, L24E, L26 Non-Turbo Inline 6 1970-83 *240/260/280Z, Cedric, Fairlady, Datsun 810*

Head Gasket

NEW!

MLS Head Gasket

Bore	Thickness	Pkg Qty	Part #	List Price
85mm	.036"	1	C4579-036	\$175.40
85mm	.040"	1	C4579-040	\$175.40
85mm	.070"	1	C4579-070	\$210.04

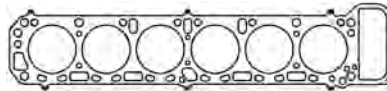

Additional thicknesses available
see page 4

L28E, L28S, L28ES Non-Turbo Inline 6 1975-80 *280Z, Patrol, Fairlady, Detric, Laurel*

Head Gasket

MLS Head Gasket

Bore	Thickness	Pkg Qty	Part #	List Price
89mm	.040"	1	C4580-040	\$175.40

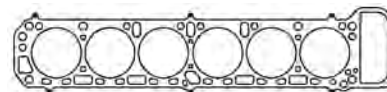

Additional thicknesses available
see page 4



Cometic Gasket - An Exclusive NASCAR Performance Product

NISSAN

RB25DET 2.5L Inline 6 Patrol 89-93, Skyline 89-93, Skyline GT-R 89-02

Head Gaskets

MLS Head Gaskets				
Bore	Thickness	Pkg Qty	Part #	List Price
86mm	.051"	1	C4317-051	\$175.38
87mm	.051"	1	C4318-051	\$175.38

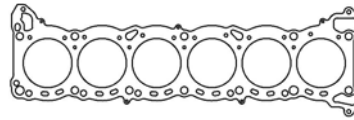

Additional thicknesses available see page 4

Individual Gaskets

Valve Cover Gasket Set		
Application	Part #	List Price
RB25DET	C4552	\$33.98

Throttle Body Gasket		
Application	Part #	List Price
RB25DET	C4767	\$2.97

Intake Manifold Gasket Set		
Application	Part #	List Price
RB25DET	C4768	\$36.06

Rear Main Seal		
Application	Part #	List Price
RB25DET	C4770	\$12.88

Exhaust Manifold Gasket		
Application	Part #	List Price
RB25DET MLS	C4177-030	\$26.99

Oil Pump Gasket		
Application	Part #	List Price
RB25DET	C4769-020	\$7.41

Cam Seal Set		
Application	Part #	List Price
RB25DET (pair)	C4739	\$8.86

Front Crank Seal		
Application	Part #	List Price
RB25DET	C4914	\$4.43

Valve Stem Seals (sold individually)		
Application	Part #	List Price
RB25DET	3175V	\$1.41

Gasket Kits

To purchase a complete gasket kit order both top end and bottom end gasket kit

TOP END GASKET KIT

Application	Part #	List Price
RB25DET 87mm Bore	PRO2016T	\$267.75

BOTTOM END GASKET KIT

Application	Part #	List Price
RB25DET	PRO2017B	\$51.30



Cometic Gasket - An Exclusive NASCAR Performance Product

NISSAN

RB26DET 2.6L DOHC Inline 6 Patrol 89-93, Skyline 89-93, Skyline GT-R 89-02

Head Gaskets

MLS Head Gaskets

Bore	Thickness	Pkg Qty	Part #	List Price
86mm	.051"	1	C4319-051	\$175.38
87mm	.051"	1	C4320-051	\$175.38
88mm	.051"	1	C4321-051	\$175.38

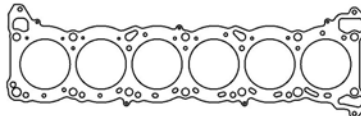

Additional thicknesses available see page 4

Individual Gaskets

Valve Cover Gasket Set

Application	Part #	List Price
RB26DET	C4552	\$33.98

Throttle Body Gasket Set

Application	Part #	List Price
RB26DET - 6 Pack	C4920	\$33.99

Intake Manifold Gasket

Application	Part #	List Price
RB26DET	C4372	\$22.10

Rear Main Seal

Application	Part #	List Price
RB26DET	C4770	\$12.88

Exhaust Manifold Gasket

Application	Part #	List Price
RB26DET MLS	C4202-030	\$26.99

Oil Pump Gasket

Application	Part #	List Price
RB20E/DE/DET 88-93	C4769-020	\$7.41

Cam Seal Set

Application	Part #	List Price
RB26DET (pair)	C4739	\$8.86

Front Crank Seal

Application	Part #	List Price
RB20E/DE/DET 88-93	C4914	\$4.43

Valve Stem Seals (sold individually)

Application	Part #	List Price
RB25DET - EXH	3158V	\$1.33
RB25DET - INT	3175V	\$1.41

Gasket Kits



To purchase a complete gasket kit order both top end and bottom end gasket kit

TOP END GASKET KIT



Application	Part #	List Price
RB26DET 87mm Bore	PRO2017T	\$348.09

BOTTOM END GASKET KIT



Application	Part #	List Price
RB26DET	PRO2017B	\$51.30



Cometic Gasket - An Exclusive NASCAR Performance Product

NISSAN

RB30DE 3.0L DOHC Inline 6 Patrol 89-93

Head Gaskets

MLS Head Gaskets

Bore	Thickness	Pkg Qty	Part #	List Price
86mm051"1	C4322-051\$170.27
87mm051"1	C4323-051\$170.27

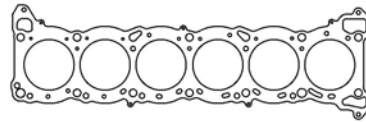

Additional thicknesses available see page 4

VG30DE/DETT 3.0L 24v DOHC V6 1990-99

Head Gaskets

MLS Head Gaskets

Bore	Thickness	Pkg Qty	Part #	List Price
88mm045"1	C4346-045\$93.53
90mm045"1	C4347-045\$93.53

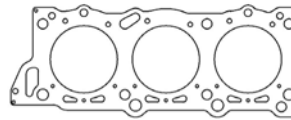

Additional thicknesses available see page 4

Valve Cover Gasket Set

Application	Part #	List Price
VG30DE/DETT	C4773\$28.31

Oil Pan Gasket

Application	Part #	List Price
VG30DE/DETT	C4776\$17.13

Intake Manifold Gasket Set

Application	Part #	List Price
VG30DE/DETT	C4772\$29.56

Rear Main Seal Set

Application	Part #	List Price
VG30DE/DETT	C4775\$13.95

Exhaust Manifold Gasket Set

Application	Part #	List Price
VG30DE/DETT	C4771-064\$48.46

Front Crank Seal

Application	Part #	List Price
VG30DE/DETT	C4914\$4.43

Thermostat Gasket

Application	Part #	List Price
VG30DE/DETT	C4774-031\$2.43

Water Pump Gasket

Application	Part #	List Price
VG30DE/DETT	C4777-015\$2.46

Cam Seals (sold in pairs)

Application	Part #	List Price
VG30DE/DETT (need 2 pairs)	C4739\$8.86

Gasket Kits



To purchase a complete gasket kit order both top end and bottom end gasket kit

TOP END GASKET KIT

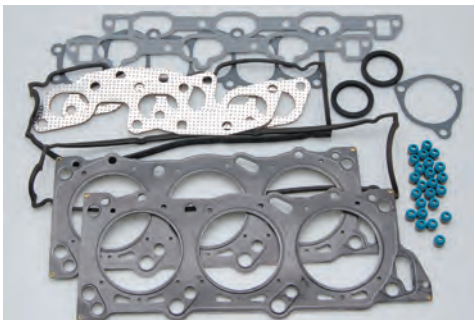

Application	Part #	List Price
VG30DE/DETT 88mm Bore	PRO2040T\$251.25

BOTTOM END GASKET KIT



Application	Part #	List Price
VG30DE/DETT	PRO2040B\$41.47



Cometic Gasket - An Exclusive NASCAR Performance Product

NISSAN

VQ30DE/VQ35DE 3.0/3.5L DOHC V6

350Z 03-06, G35 03-06, Altima 02-06, I35 02-04, Maxima 02-04, Pathfinder 01-04, Skyline 01-06

Head Gaskets

MLS Head Gaskets - Left Side

Bore	Thickness	Pkg Qty	Part #	List Price
96mm	.030"	1	C4345-030	\$96.95
98mm	.030"	1	C4344-030	\$96.95
100mm	.030"	1	C4343-030	\$96.95
101.5mm	.030"	1	C4381-030	\$96.95

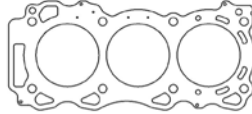

Additional thicknesses available
see page 4

MLS Head Gaskets - Right Side

Bore	Thickness	Pkg Qty	Part #	List Price
96mm	.030"	1	C4361-030	\$96.95
98mm	.030"	1	C4362-030	\$96.95
100mm	.030"	1	C4363-030	\$96.95
101.5mm	.030"	1	C4380-030	\$96.95

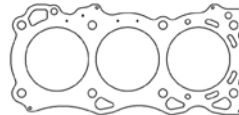

Additional thicknesses available
see page 4

Individual Gaskets

Exhaust Manifold Gasket Set

Application	Part #	List Price
VQ30DE/VQ35DE	C4921-064	\$29.00

VQ35HR/VQ37VHR 3.5/3.7L DOHC V6 G35 07-08, 350Z 07-08, G37 08-Up, 370Z 09-Up

Head Gaskets

NEW!

MLS Head Gasket - Left Side

Bore	Thickness	Pkg Qty	Part #	List Price
97mm	.030"	1	C4593-030	\$95.69
97mm	.075"	1	C4593-075	\$126.02

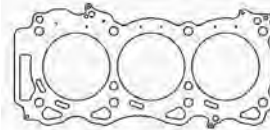

Additional thicknesses available
see page 4

NEW!

MLS Head Gasket - Right Side

Bore	Thickness	Pkg Qty	Part #	List Price
97mm	.030"	1	C4592-030	\$96.59
97mm	.075"	1	C4592-075	\$126.02

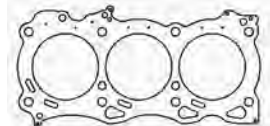

Additional thicknesses available
see page 4

Individual Gaskets

Exhaust Manifold Gasket Set

Application	Part #	List Price
VQ35HR/VQ37VHR	C4921-064	\$29.00

VR38DETT 3.8L DOHC V6 GT-R 08-Up

Head Gaskets

MLX Head Gaskets - Left Side

Bore	Thickness	Pkg Qty	Part #	List Price
96mm	.032"	1	C4570-032	\$96.70
100mm	.032"	1	C4572-032	\$96.70

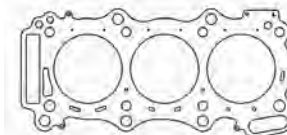

Additional thicknesses available
see page 4

MLX Head Gaskets - Right Side

Bore	Thickness	Pkg Qty	Part #	List Price
96mm	.032"	1	C4571-032	\$96.70
100mm	.032"	1	C4573-032	\$96.70

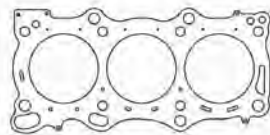

Additional thicknesses available
see page 4



Cometic Gasket - An Exclusive NASCAR Performance Product

NISSAN

VK45DE 4.5L V8 Infinity Q45 02-06

Head Gaskets

MLS Head Gasket - Left Side				
Bore	Thickness	Pkg Qty	Part #	List Price
93.5mm	.036"	1	C4486-036	\$92.83

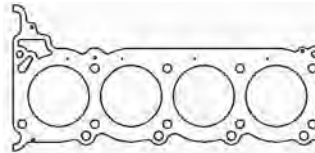

Additional thicknesses available see page 4

MLS Head Gasket - Right Side				
Bore	Thickness	Pkg Qty	Part #	List Price
93.5mm	.036"	1	C4485-036	\$92.83

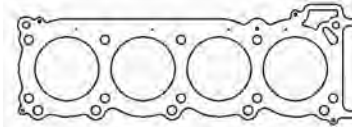

Additional thicknesses available see page 4

TB48DE 4.8L DOHC Inline 6 2001-Up

Head Gaskets

MLS Head Gasket				
Bore	Thickness	Pkg Qty	Part #	List Price
100.5mm	.030"	1	C4511-030	\$175.38

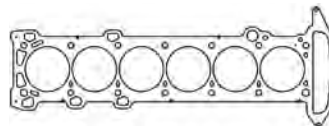

Additional thicknesses available see page 4

MLx Head Gasket				
Bore	Thickness	Pkg Qty	Part #	List Price
100.5mm	.040"	1	C4599-040	\$241.49

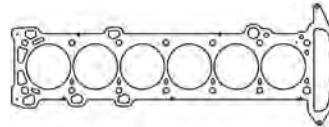

VK56DE 5.6L DOHC V8 2004-Up Armada, 2004-Up Titan, 2004-10 QX56, 2008-12 Pathfinder

Head Gaskets

MLS Head Gasket - Left Side				
Bore	Thickness	Pkg Qty	Part #	List Price
100mm	.040"	1	C4922-040	\$92.83

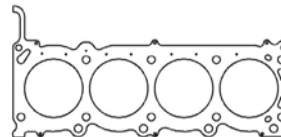

Additional thicknesses available see page 4

MLS Head Gasket - Right Side				
Bore	Thickness	Pkg Qty	Part #	List Price
100mm	.040"	1	C4923-040	\$92.83

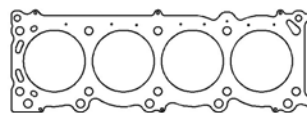

Additional thicknesses available see page 4

MLX Head Gasket - Left Side				
Bore	Thickness	Pkg Qty	Part #	List Price
102.7mm	.040"	1	C4610-040	\$131.16

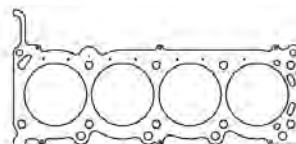

Additional thicknesses available see page 4

MLX Head Gasket - Right Side				
Bore	Thickness	Pkg Qty	Part #	List Price
102.7mm	.040"	1	C4609-040	\$131.16

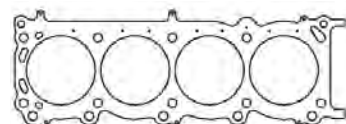

Additional thicknesses available see page 4

Individual Gaskets

Exhaust Manifold Gasket Set		
Application	Part #	List Price
VK56VD 2010-2016 MLS	C4959-030	\$58.40

Exhaust Manifold Gasket Set		
Application	Part #	List Price
VK56DE 2004-09 Oval Port MLS	C4961-030	\$58.40
VK56DE 2004-09 Oval Port AM	C4967-064	\$30.80



Cometic Gasket - An Exclusive NASCAR Performance Product

PEUGEOT/CITROEN

TU5J4 1.6L 16v: 106 1997-05

Head Gaskets

MLS Head Gasket

Bore	Thickness	Pkg Qty	Part #	List Price
79mm060"1	C4493-060\$132.87

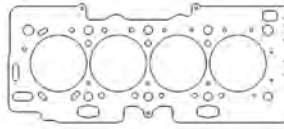

Additional thicknesses available
see page 4

XU9J4, XU9J4Z 1.9L DOHC, XU10J2, XU10J4 2.0L 405 M1-16, 605 S/SR1

Head Gaskets

MLS Head Gaskets

Bore	Thickness	Pkg Qty	Part #	List Price
84mm051"1	C4225-051\$105.21
85mm051"1	C4226-051\$105.21
86.5mm051"1	C4227-051\$105.21
88mm051"1	C4228-051\$105.21

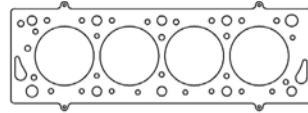

Additional thicknesses available
see page 4

PORSCHE

924 2.0L 1976-85

Head Gasket

MLS Head Gasket

Bore	Thickness	Pkg Qty	Part #	List Price
88mm050"1	C4542-050\$119.96

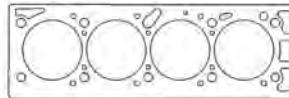

Additional thicknesses available
see page 4

944 2.5L 1982-91

Head Gaskets

MLS Head Gasket

Bore	Thickness	Pkg Qty	Part #	List Price
100.5mm040"1	C4272-040\$93.53
103mm040"1	C4273-040\$93.53

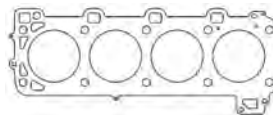

Additional thicknesses available
see page 4

Cam Cover Gasket

Application	Part #	List Price
944 2.5L 82-91	C4925\$29.16

Intake Manifold Gasket Set

Application	Part #	List Price
944 2.5L 82-91 - 4pcs	C4924\$8.91

944 2.7L 1989, 3.0L 1989-91

Head Gasket

MLS Head Gasket

Bore	Thickness	Pkg Qty	Part #	List Price
106mm040"1	C4274-040\$93.53

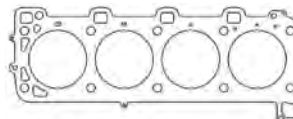

Additional thicknesses available
see page 4

Cam Cover Gasket

Application	Part #	List Price
944 2.7/3.0L	C4925\$29.16

Intake Manifold Gasket Set

Application	Part #	List Price
944 2.7/3.0L - 4pcs	C4924\$8.91



Cometic Gasket - An Exclusive NASCAR Performance Product

PORSCHE

996 3.6L Twin Turbo 2001-04

Head Gasket

MLS Head Gasket				
Bore	Thickness	Pkg Qty	Part #	List Price
102mm040"1	C4492-040	\$93.53

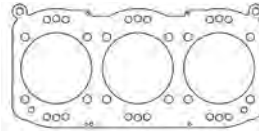

Additional thicknesses available see page 4

997 3.6L Twin Turbo 2006-08

Head Gasket

MLX Head Gasket				
Bore	Thickness	Pkg Qty	Part #	List Price
102mm032"1	C4926-032	\$96.70

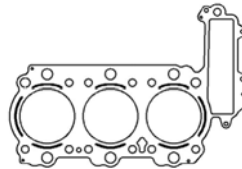

Additional thicknesses available see page 4

Cayenne GTS 4.5L 2003-06 V8

Head Gaskets

MLS Head Gasket - Left Side				
Bore	Thickness	Pkg Qty	Part #	List Price
95mm027"1	C4535-027	\$93.53

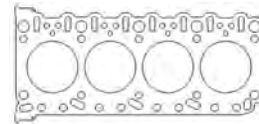

Additional thicknesses available see page 4

MLS Head Gasket - Right Side				
Bore	Thickness	Pkg Qty	Part #	List Price
95mm027"1	C4536-027	\$93.53

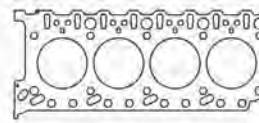

Intake Manifold Gasket Set		
Application	Part #	List Price
Cayenne 4.5L 03-06 (pair)	C4927	\$27.04

928 4.7/5.0L 1983-97

Head Gaskets

MLS Head Gaskets - Left Side				
Bore	Thickness	Pkg Qty	Part #	List Price
100mm045"1	C5781-045	\$93.53
104mm045"1	C5783-045	\$93.53

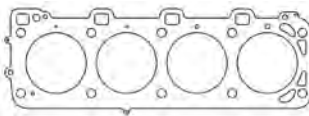

Additional thicknesses available see page 4

MLS Head Gaskets - Right Side				
Bore	Thickness	Pkg Qty	Part #	List Price
100mm045"1	C5780-045	\$93.53
104mm045"1	C5782-045	\$93.53

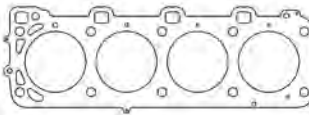



Cometic Gasket - An Exclusive NASCAR Performance Product

RENAULT

F4P 16v 1.8L, F4R 16v 2.0L *Lagina 98-Up, Clio 01-Up*

Head Gaskets

MLS Head Gaskets

Bore	Thickness	Pkg Qty	Part #	List Price
83mm	.030"	1	C4518-030	\$105.21
84.5mm	.030"	1	C4519-030	\$105.21

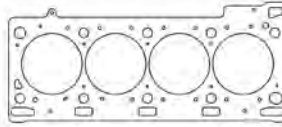

Additional thicknesses available
see page 4

F7P 16v 1.8L, F7R 16v 2.0L

R19 89-96, Clio 91-97, Megane Coupe 95-99, Clio Williams 93-95, Spider Sport 1995

Head Gaskets

MLS Head Gaskets

Bore	Thickness	Pkg Qty	Part #	List Price
83mm	.051"	1	C4539-051	\$105.21
84mm	.051"	1	C4540-051	\$105.21

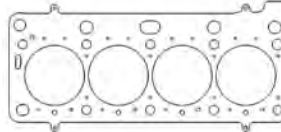

Additional thicknesses available
see page 4

ROVER

15G V8 1970-93, 21D-25D V8 1970-93, 35D-38D 1970-93

Range Rover 1970-89, Discovery 1989-93

Head Gaskets

MLS Head Gasket

Bore	Thickness	Pkg Qty	Part #	List Price
89mm	.040"	1	C4367-040	\$95.86
94mm	.040"	1	C4368-040	\$95.86
96mm	.040"	1	C4369-040	\$95.86

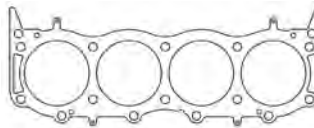

Additional thicknesses available
see page 4

Exhaust Manifold Gasket Set

Application	Part #	List Price
Rover V8 .064" AM	C4966-064	\$27.40

35D-38D, 40D, 42D-46D V8 1994-Up *Discovery 1994-Up*

Head Gaskets

MLS Head Gaskets

Bore	Thickness	Pkg Qty	Part #	List Price
89mm	.040"	1	C4366-040	\$95.86
94mm	.040"	1	C4365-040	\$95.86
96mm	.040"	1	C4364-040	\$95.86

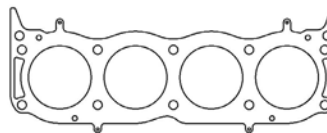

Additional thicknesses available
see page 4

Exhaust Manifold Gasket Set

Application	Part #	List Price
Rover V8 .064" AM	C4966-064	\$27.40



Cometic Gasket - An Exclusive NASCAR Performance Product

ROVER

5.0L V8 "LR-V8"

2009-Up Discovery, Range Rover Sport, Range Rover Sport SC, Range Rover, Range Rover SC

Head Gaskets

MLX Head Gaskets - Left Side

Bore	Thickness	Pkg Qty	Part #	List Price
93mm	.040"	1	C15001-040	\$103.16

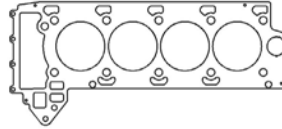

Additional thicknesses available see page 4

MLX Head Gaskets - Right Side

Bore	Thickness	Pkg Qty	Part #	List Price
93mm	.040"	1	C15000-040	\$103.16

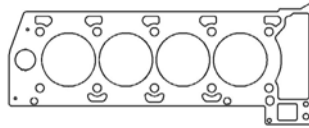

Additional thicknesses available see page 4

SAAB

B204 1985cc/B234 2290cc Turbo 2.0L: 1995-99 9-3, 9-5, 900

Head Gaskets

NEW!

MLS Head Gaskets

Bore	Thickness	Pkg Qty	Part #	List Price
91mm	.030"	1	C4974-030	\$116.88



Additional thicknesses available see page 4

B205 1985cc/B235 2290cc Turbo 2.0L: 1999-09 9-3, 9-5

Head Gaskets

NEW!

MLS Head Gaskets

Bore	Thickness	Pkg Qty	Part #	List Price
91mm	.030"	1	C4973-030	\$116.88

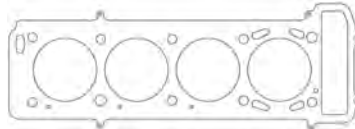

Additional thicknesses available see page 4

SUBARU

FA20DIT DOHC 2.0L: 2015+Up WRX

Head Gaskets

MLX Head Gasket - Left Side

Bore	Thickness	Pkg Qty	Part #	List Price
89.5mm	.032"	1	C4954-032	\$74.25

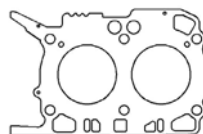

Additional thicknesses available see page 4

MLX Head Gasket - Right Side

Bore	Thickness	Pkg Qty	Part #	List Price
89.5mm	.032"	1	C4955-032	\$74.25

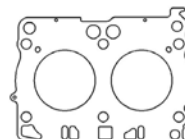

Additional thicknesses available see page 4



Cometic Gasket - An Exclusive NASCAR Performance Product

SUBARU

FA20 DOHC 2.0L 2012+Up BRZ

Head Gaskets

MLX Head Gasket - Left Side

Bore	Thickness	Pkg Qty	Part #	List Price
89.5mm032"1	C4589-032	\$74.25

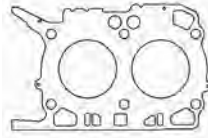

Additional thicknesses available
see page 4

MLX Head Gasket - Right Side

Bore	Thickness	Pkg Qty	Part #	List Price
89.5mm032"1	C4588-032	\$74.25

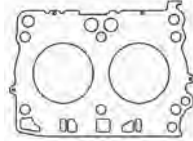

Additional thicknesses available
see page 4

EJ20E SOHC 2.0L 16v JDM 1990-97 Legacy, 1995-97 Impreza

Head Gasket

MLS Head Gasket

Bore	Thickness	Pkg Qty	Part #	List Price
93mm040"1	C4260-040	\$50.23

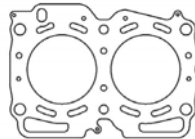

Additional thicknesses available
see page 4

EJ205 DOHC 2.0L 16v 2002-05 WRX, 2004-05 Saab 9-2X Aero

Head Gasket

MLX Head Gasket

Bore	Thickness	Pkg Qty	Part #	List Price
93mm041"1	C4590-041	\$74.25

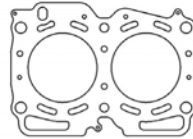

Additional thicknesses available
see page 4

Individual Gaskets

Valve Cover Gasket Sets

Application	Part #	List Price
EJ205 02-05 - Left Side	C4863	\$31.71
EJ205 02-05 - Right Side	C4864	\$31.71

Valve Stem Seals (sold individually)

Application	Part #	List Price
EJ205 02-05 - Exhaust (Brown)	3264V	\$1.67
EJ205 02-05 - Intake (Black)	3265V	\$2.14

Intake Manifold Gaskets

Application	Part #	List Price
EJ205 02-05	C4857-039	\$20.93

Rear Main Seal

Application	Part #	List Price
EJ205 02-05	C4856	\$10.92

Exhaust Gaskets

Application	Part #	List Price
EJ205 02-05 Manifold MLS (2)	C4204-030	\$17.92
EJ205 02-05 Exhaust Pipe (2)	C4856-064	\$9.37
EJ205 02-05 Crossover (2)	C4859-064	\$9.89

Front Crank Seal

Application	Part #	List Price
EJ205 02-05	C4857	\$6.33

Throttle Body Gasket

Application	Part #	List Price
EJ205 02-05	C4855-060	\$5.73

Water Pump Gasket

Application	Part #	List Price
EJ205 02-05	C4860-018	\$5.88

See page 125 for additional gaskets



Cometic Gasket - An Exclusive NASCAR Performance Product

SUBARU

EJ205 DOHC 2.0L 16V 2002-05 WRX, 2004-05 Saab 9-2X Aero

Individual Gaskets

Cam Seal Set		
Application	Part #	List Price
EJ205 02-05 - 4 Pack	C4858	\$24.30

Thermostat Gasket		
Application	Part #	List Price
EJ205 02-05	C4861	\$4.51

Gasket Kits

Application	Part #	List Price
EJ205 02-03 93.5mm Bore	PRO2044C	\$345.21

Application	Part #	List Price
EJ205 04-05	PRO2023C	\$262.18

EJ22E SOHC 2.2L 16V 1990-96 Legacy, 1993-96 Impreza

Head Gasket

NEW!

MLS Head Gasket				
Bore	Thickness	Pkg Qty	Part #	List Price
98mm	.040"	1	C4262-040	\$50.23
100mm	.040"	1	C4985-040	\$50.23

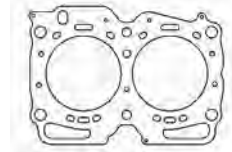

Additional thicknesses available see page 4

NEW!

MLX Head Gasket				
Bore	Thickness	Pkg Qty	Part #	List Price
101mm	.041"	1	C4986-041	\$74.25

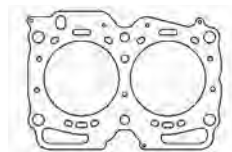

Individual Gaskets

Valve Cover Gasket Set		
Application	Part #	List Price
EJ22E SOHC	C4871	\$31.71

Thermostat Gasket		
Application	Part #	List Price
EJ22E SOHC	C4861	\$4.51

Intake Manifold Gasket Set		
Application	Part #	List Price
EJ22E SOHC	C4868-060	\$18.62

Oil Pan Gasket		
Application	Part #	List Price
EJ22E SOHC - Cork	C4869-125	\$11.25

Exhaust Gaskets		
Application	Part #	List Price
EJ22E SOHC MLS	C4204-030	\$17.92

Rear Main Seal		
Application	Part #	List Price
EJ22E SOHC	C4856	\$10.92

See page 126 for additional gaskets



Cometic Gasket - An Exclusive NASCAR Performance Product

SUBARU

EJ22E SOHC 2.2L 16V 1990-96 Legacy, 1993-96 Impreza

Throttle Body Gasket		
Application	Part #	List Price
EJ22E SOHC.....	C4867-060	\$5.73

Front Crank Seal		
Application	Part #	List Price
EJ22E SOHC.....	C4857	\$6.33

Cam Seal Set		
Application	Part #	List Price
EJ22E SOHC - 2 pack.....	C4870	\$16.28

Water Pump Gasket		
Application	Part #	List Price
EJ22E SOHC.....	C4860-018	\$5.88

Valve Stem Seals (sold individually)		
Application	Part #	List Price
EJ22E SOHC - Exhaust (Brown).....	3264V	\$1.67
EJ22E SOHC - Intake (Black).....	3265V	\$2.14

Timing Cover Set		
Application	Part #	List Price
EJ22E SOHC.....	C4862	\$46.54

Gasket Kit



GASKET KIT

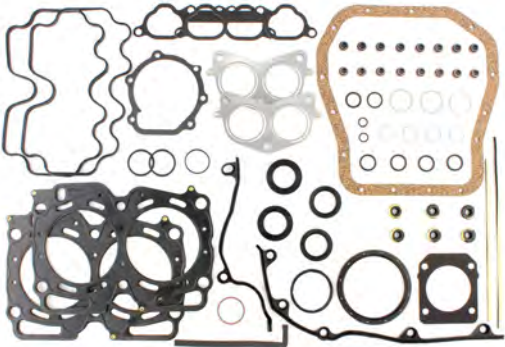

Application	Part #	List Price
EJ22E SOHC 98mm Bore.....	PRO2026C	\$256.72

EJ22ET SOHC 2.2L 16v Turbo 1991-94 Legacy

Head Gasket

MLS Head Gasket				
Bore	Thickness	Pkg Qty	Part #	List Price
98mm.....	.051".....	1.....	C4263-051	\$50.23

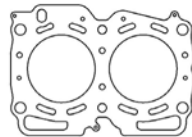

Additional thicknesses available see page 4

Individual Gaskets

Valve Cover Gasket Set		
Application	Part #	List Price
EJ22ET SOHC Turbo.....	C4871	\$31.71

Oil Pan Gasket		
Application	Part #	List Price
EJ22ET SOHC Turbo.....	C4869-125	\$11.25

Intake Manifold Gasket Set		
Application	Part #	List Price
EJ22ET SOHC Turbo.....	C4868-060	\$18.62

Rear Main Seal		
Application	Part #	List Price
EJ22ET SOHC Turbo.....	C4856	\$10.92

Cam Seal Set		
Application	Part #	List Price
EJ22ET SOHC Turbo - 2pcs.....	C4870	\$16.28

Front Crank Seal		
Application	Part #	List Price
EJ22ET SOHC Turbo.....	C4857	\$6.33

Valve Stem Seals (sold individually)		
Application	Part #	List Price
EJ22ET SOHC - Exhaust (Brown).....	3264V	\$1.67
EJ22ET SOHC - Intake (Black).....	3265V	\$2.14

Water Pump Gasket		
Application	Part #	List Price
EJ22ET SOHC Turbo.....	C4860-018	\$5.88



Cometic Gasket - An Exclusive NASCAR Performance Product

SUBARU

EJ25D DOHC 2.5L 16V 1998 Impreza RS, 1996-99 Legacy/Outback, 1998 Forester

Head Gasket

MLX Head Gasket				
Bore	Thickness	Pkg Qty	Part #	List Price
101mm051"1	C4578-051	\$74.25

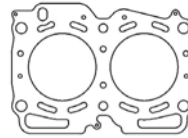

Additional thicknesses available see page 4

Individual Gaskets

Valve Cover Gasket Set		
Application	Part #	List Price
EJ25D DOHC	C4873	\$45.31

Thermostat Gasket		
Application	Part #	List Price
EJ25D DOHC	C4861	\$4.51

Intake Manifold Gasket Set		
Application	Part #	List Price
EJ25D DOHC	C4872-059	\$26.92

Oil Pan Gasket		
Application	Part #	List Price
EJ25D DOHC - Cork	C4869-125	\$11.25

Exhaust Gaskets		
Application	Part #	List Price
EJ25D DOHC MLS	C4204-030	\$17.92

Timing Cover Set		
Application	Part #	List Price
EJ25D DOHC	C4862	\$46.54

Throttle Body Gasket		
Application	Part #	List Price
EJ25D DOHC	C4867-060	\$5.73

Rear Main Seal		
Application	Part #	List Price
EJ25D DOHC	C4856	\$10.92

Cam Seal Set		
Application	Part #	List Price
EJ25D DOHC - 4pcs	C4866	\$32.56

Front Crank Seal		
Application	Part #	List Price
EJ25D DOHC	C4857	\$6.33

Valve Stem Seals (sold individually)		
Application	Part #	List Price
EJ25D DOHC - Exhaust (Brown)	3264V	\$1.67
EJ25D DOHC - Intake (Black)	3265V	\$4.82

Water Pump Gasket		
Application	Part #	List Price
EJ25D DOHC	C4860-018	\$5.88

Gasket Kit

STREETpro
By Cometic Gasket

GASKET KIT

Application	Part #	List Price
EJ25D DOHC 1996-99 101mm Bore	PRO2025C	\$326.64



Cometic Gasket - An Exclusive NASCAR Performance Product

SUBARU

EJ251/EJ253 SOHC 2.5L 16v

(EJ251): 09/00-03/03 Impreza, 00-02,04 Outback Sport, 11/01-03/04 Forester, 06/99-06/06 Legacy/Outback, 06/02-04/06 Baja
 (EJ253): 01/04-Up Forester, 04/03+Up Impreza, 11/03-04/09 Legacy/Outback

Head Gasket

MLX Head Gasket

Bore	Thickness	Pkg Qty	Part #	List Price
101mm032"1	C4578-032\$74.25

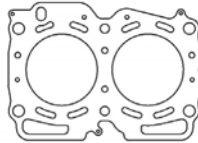

Additional thicknesses available
see page 4

Individual Gaskets

Valve Cover Gasket Set

Application	Part #	List Price
EJ251 SOHC	C4642\$33.98

Throttle Body Gasket

Application	Part #	List Price
EJ251 SOHC	C4874-060\$5.73

Intake Manifold Gasket Set

Application	Part #	List Price
EJ251 SOHC	C4875-060\$20.93

Thermostat Gasket

Application	Part #	List Price
EJ251 SOHC	C4861\$4.51

Exhaust Gaskets

Application	Part #	List Price
EJ251 SOHC MLS	C4204-030\$17.92

Rear Main Seal

Application	Part #	List Price
EJ251 SOHC	C4856\$10.92

Cam Seal Set

Application	Part #	List Price
EJ251 SOHC 2pcs	C4870\$16.28

Front Crank Seal

Application	Part #	List Price
EJ251 SOHC	C4857\$6.33

Valve Stem Seals (sold individually)

Application	Part #	List Price
EJ251 SOHC - Exhaust (Brown)	3264V\$1.67
EJ251 SOHC - Intake (Black)	3265V\$2.14

Water Pump Gasket

Application	Part #	List Price
EJ251 SOHC	C4860-018\$5.88

Gasket Kit



GASKET KIT

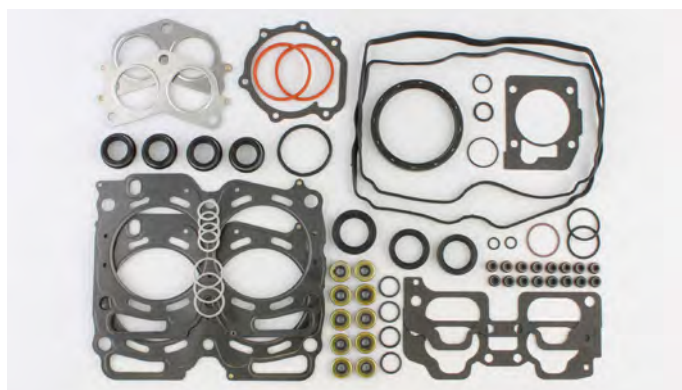

Application	Part #	List Price
EJ251 SOHC 1999-05 101mm Bore	PRO2022C\$213.00



Cometic Gasket - An Exclusive NASCAR Performance Product

SUBARU

EJ253 SOHC 2.5L 16v 02/09-12/14 Legacy/Outback non-turbo

Head Gaskets

MLX Head Gasket - "Improved Cooling Heads"				
Bore	Thickness	Pkg Qty	Part #	List Price
101mm032"1	C4622-032	\$74.25

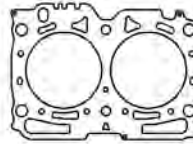

Additional thicknesses available
see page 4

Individual Gaskets

Intake Manifold Gasket Set		
Application	Part #	List Price
EJ253 SOHC	C4875-060	\$20.93

Thermostat Gasket		
Application	Part #	List Price
EJ253 SOHC	C4861	\$4.51

Exhaust Gaskets		
Application	Part #	List Price
EJ253 SOHC MLS	C4204-030	\$17.92

Rear Main Seal		
Application	Part #	List Price
EJ253 SOHC	C4856	\$10.92

Cam Seal Set		
Application	Part #	List Price
EJ253 SOHC 2pcs	C4870	\$16.28

Front Crank Seal		
Application	Part #	List Price
EJ253 SOHC	C4857	\$6.33

Valve Stem Seals (sold individually)		
Application	Part #	List Price
EJ253 SOHC - Exhaust (Brown)	3264V	\$1.67
EJ253 SOHC - Intake (Black)	3265V	\$2.14

Water Pump Gasket		
Application	Part #	List Price
EJ253 SOHC	C4860-018	\$5.88

EJ255 DOHC 2.5L 16v Turbo 02/03-04/06 Baja Turbo3-03/05 Forester XT, 02/03-06/06 Legacy/Outback Turbo

Head Gasket

MLX Head Gasket				
Bore	Thickness	Pkg Qty	Part #	List Price
101mm032"1	C4578-032	\$74.25

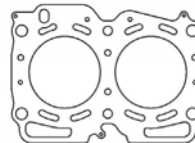

Additional thicknesses available
see page 4

EJ255 DOHC 2.5L 16v Turbo 01/05-03/08 Forester XT, 04/05-03/08 Impreza WRX, 11/05-04/09 Legacy/Outback Turbo

Head Gasket

MLX Head Gasket - "Improved Cooling Heads"				
Bore	Thickness	Pkg Qty	Part #	List Price
101mm032"1	C4622-032	\$74.25

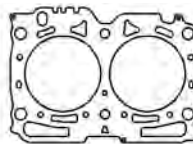

Additional thicknesses available
see page 4

Individual Gaskets

Valve Cover Gasket Sets		
Application	Part #	List Price
EJ255 06-07 - Left Side	C4880	\$22.65
EJ255 06-07 - Right Side	C4881	\$22.65

Throttle Body Gasket		
Application	Part #	List Price
EJ255 DOHC 06-07	C4877-060	\$5.73

Intake Manifold Gasket Set		
Application	Part #	List Price
EJ255 DOHC 06-07	C4857-039	\$20.93

Thermostat Gasket		
Application	Part #	List Price
EJ255 DOHC 06-07	C4861	\$4.51

See page 130 for additional gaskets



Cometic Gasket - An Exclusive NASCAR Performance Product

SUBARU

EJ255 DOHC 2.5L 16v Turbo 01/05-03/08 Forester XT, 04/05-03/08 Impreza WRX,
11/05-04/09 Legacy/Outback Turbo

Individual Gaskets

Exhaust Gaskets

Application	Part #	List Price
EJ255 06-07 Manifold MLS (2).....	C4204-030	\$17.92
EJ255 06-07 Crossover (2)	C4859-064	\$9.89

Cam Seal Sets

Application	Part #	List Price
EJ255 06-07 Exhaust Seals (2).....	C4878	\$12.15
EJ255 06-07 Intake Seals (2).....	C4879	\$19.43

Valve Stem Seals (sold individually)

Application	Part #	List Price
EJ255 DOHC - Exhaust (Brown).....	3264V	\$1.67
EJ255 DOHC - Intake (Black).....	3265V	\$2.14

Rear Main Seal

Application	Part #	List Price
EJ255 DOHC 06-07.....	C4856	\$10.92

Front Crank Seal

Application	Part #	List Price
EJ255 DOHC 06-07.....	C4857	\$6.33

Water Pump Gasket

Application	Part #	List Price
EJ255 DOHC 06-07.....	C4860-018	\$5.88

Timing Cover Set

Application	Part #	List Price
EJ255 DOHC 06-07.....	C4862	\$45.18

Gasket Kit



GASKET KIT

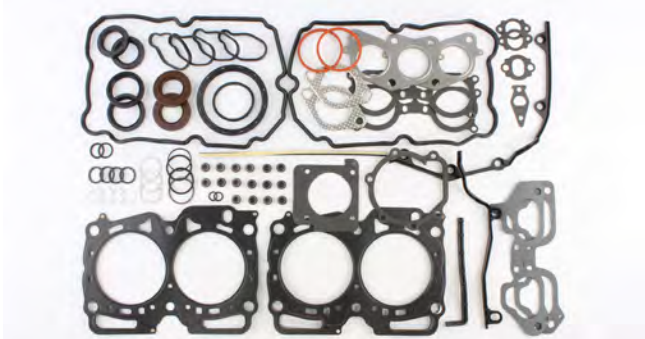

Application	Part #	List Price
EJ255 DOHC 2006-07 101mm Bore.....	PRO2045C	\$345.21

EJ255 DOHC 2.5L 16v Turbo 04/08-Up Forester XT, 04/08-Up Impreza WRX, 02/09-Up Legacy/Outback Turbo

Head Gasket

MLX Head Gasket

Bore	Thickness	Pkg Qty	Part #	List Price
101mm032"1	C4587-032	\$74.25

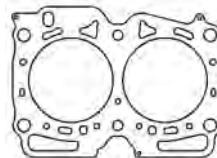

Additional thicknesses available
see page 4

Individual Gaskets

Valve Cover Gasket Sets

Application	Part #	List Price
EJ255 08-Up - Left Side	C4880	\$22.65
EJ255 08-Up - Right Side.....	C4881	\$22.65

Throttle Body Gasket

Application	Part #	List Price
EJ255 DOHC 08-Up.....	C4882	\$4.57

See page 131 for additional gaskets



Cometic Gasket - An Exclusive NASCAR Performance Product

SUBARU

EJ255 DOHC 2.5L 16v Turbo 04/08-Up Forester XT, 04/08-Up Impreza WRX, 02/09-Up Legacy/Outback Turbo

Individual Gaskets

Intake Manifold Gasket Set		
Application	Part #	List Price
EJ255 DOHC 08-Up	C4857-039	\$20.93

Thermostat Gasket		
Application	Part #	List Price
EJ255 DOHC 08-Up	C4861	\$4.57

Exhaust Gaskets		
Application	Part #	List Price
EJ255 08-Up Manifold MLS (2)	C4204-030	\$17.92

Rear Main Seal		
Application	Part #	List Price
EJ255 DOHC 08-Up	C4856	\$10.92

Cam Seal Sets		
Application	Part #	List Price
EJ255 08-Up Exh Seals (2)	C4878	\$12.15
EJ255 08-Up Intake Seals (2)	C4879	\$19.43

Front Crank Seal		
Application	Part #	List Price
EJ255 DOHC 08-Up	C4857	\$6.33

Valve Stem Seals (sold individually)		
Application	Part #	List Price
EJ255 DOHC - Exhaust (Brown)	3264V	\$1.67
EJ255 DOHC - Intake (Black)	3265V	\$2.14

Water Pump Gasket		
Application	Part #	List Price
EJ255 DOHC 08-Up	C4860-018	\$5.88

Gasket Kit



GASKET KIT

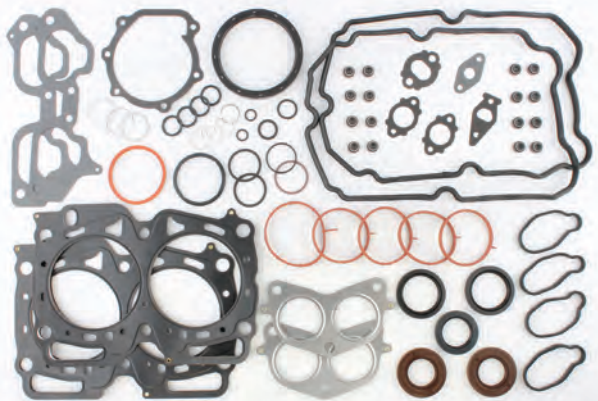

Application	Part #	List Price
EJ255 DOHC 2008-Up 101mm Bore	PRO2046C	\$316.81

EJ257 DOHC 2.5L 16v Turbo

10/02-06/07 Impreza STi

Head Gasket

MLX Head Gasket				
Bore	Thickness	Pkg Qty	Part #	List Price
101mm032"	1	C4578-032	\$74.25

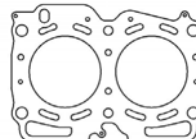

Additional thicknesses available
see page 4

See page 132 for additional gaskets



Cometic Gasket - An Exclusive NASCAR Performance Product

SUBARU

EJ257 DOHC 2.5L 16v Turbo 10/02-06/07 Impreza STI

Individual Gaskets

Valve Cover Gasket Sets

Application	Part #	List Price
EJ257 04-06 - Left Side.....	C4928	\$22.65
EJ257 04-06 - Right Side	C4929	\$22.65
EJ257 2007 - Left Side.....	C4880	\$22.65
EJ257 2007 - Right Side.....	C4881	\$22.65

Intake Manifold Gasket Set

Application	Part #	List Price
EJ257 DOHC 04-07.....	C4857-039	\$20.93

Exhaust Gaskets

Application	Part #	List Price
EJ257 04-07 Manifold MLS (2).....	C4204-030	\$17.92
EJ257 04-07 Crossover (1)	C5718	\$4.94

Cam Seal Sets

Application	Part #	List Price
EJ257 04-07 Exh Seals (2).....	C4878	\$12.15
EJ257 04-07 Intake Seals (2).....	C4879	\$19.43

Valve Stem Seals (sold individually)

Application	Part #	List Price
EJ257 DOHC - Exhaust (Brown).....	3264V	\$1.67
EJ257 DOHC - Intake (Black).....	3265V	\$2.14

Throttle Body Gasket

Application	Part #	List Price
EJ257 DOHC 04-07.....	C4877-060	\$5.73

Thermostat Gasket

Application	Part #	List Price
EJ257 DOHC 04-07.....	C4861	\$4.51

Timing Cover Set

Application	Part #	List Price
EJ257 DOHC 2007.....	C4862	\$46.54

Rear Main Seal

Application	Part #	List Price
EJ257 DOHC 04-07.....	C4856	\$10.92

Front Crank Seal

Application	Part #	List Price
EJ257 DOHC 04-07.....	C4857	\$6.33

Water Pump Gasket

Application	Part #	List Price
EJ257 DOHC 04-07.....	C4860-018	\$5.88

Gasket Kits



GASKET KIT



Application	Part #	List Price
EJ257 DOHC 04-06 101mm Bore.....	PRO2024C	\$272.01

GASKET KIT



Application	Part #	List Price
EJ257 DOHC 2007 101mm Bore	PRO2047C	\$323.37



Cometic Gasket - An Exclusive NASCAR Performance Product

SUBARU

EJ257 DOHC 2.5L 16v Turbo 04/07-Up Impreza Sti

Head Gasket

MLX Head Gasket				
Bore	Thickness	Pkg Qty	Part #	List Price
101mm	.032"	1	C4587-032	\$74.25

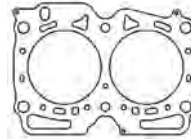

Additional thicknesses available
see page 4

Individual Gaskets

Valve Cover Gasket Sets		
Application	Part #	List Price
EJ257 08+Up - Left Side	C4880	\$22.65
EJ257 08-Up - Right Side	C4881	\$22.65

Throttle Body Gasket		
Application	Part #	List Price
EJ257 DOHC 08-Up	C4877-060	\$5.73

Intake Manifold Gasket Set		
Application	Part #	List Price
EJ257 DOHC 08-Up	C4857-039	\$20.93

Thermostat Gasket		
Application	Part #	List Price
EJ257 DOHC 08-Up	C4861	\$4.51

Exhaust Gaskets		
Application	Part #	List Price
EJ257 08-Up Manifold MLS (2)	C4204-030	\$17.92
EJ257 08-Up Crossover (1)	C5718	\$4.94

Timing Cover Set		
Application	Part #	List Price
EJ257 DOHC 08-Up	C4862	\$46.54

Cam Seal Set		
Application	Part #	List Price
EJ257 08+Up 4pcs	C4876	\$37.72

Rear Main Seal		
Application	Part #	List Price
EJ257 DOHC 08-Up	C4856	\$10.92

Valve Stem Seals (sold individually)		
Application	Part #	List Price
EJ257 DOHC - Exhaust (Brown)	3264V	\$1.67
EJ257 DOHC - Intake (Black)	3265V	\$2.14

Front Crank Seal		
Application	Part #	List Price
EJ257 DOHC 08-Up	C4857	\$6.33

Water Pump Gasket		
Application	Part #	List Price
EJ257 DOHC 08-Up	C4860-018	\$5.88

Gasket Kit



GASKET KIT



Application	Part #	List Price
EJ257 DOHC 08-Up 101mm Bore	PRO2048C	\$334.20



Cometic Gasket - An Exclusive NASCAR Performance Product

SUBARU

EZ30 3.0L Flat 6 Legacy/Outback

Head Gaskets

MLS Head Gasket - Left Side

Bore	Thickness	Pkg Qty	Part #	List Price
90mm040"1	C5861-040\$85.33

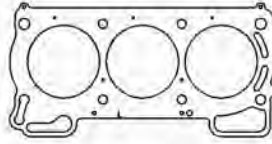

Additional thicknesses available
see page 4

MLS Head Gasket - Right Side

Bore	Thickness	Pkg Qty	Part #	List Price
90mm040"1	C5860-040\$85.33

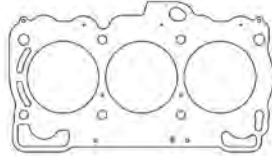

Additional thicknesses available
see page 4

EZ30D 3.0L Flat 6 2003-09 Legacy/Outback, 2006-07 Tirbeca

Head Gaskets

MLS Head Gasket - Left Side

Bore	Thickness	Pkg Qty	Part #	List Price
90mm040"1	C4623-040\$85.33

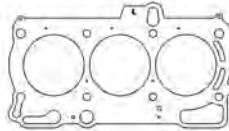

Additional thicknesses available
see page 4

MLS Head Gasket - Right Side

Bore	Thickness	Pkg Qty	Part #	List Price
90mm040"1	C4624-040\$85.33

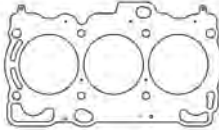

Additional thicknesses available
see page 4

EG33 3.3L Flat 6 3318cc 1992-96 SVX

Head Gaskets

MLS Head Gaskets

Bore	Thickness	Pkg Qty	Part #	List Price
98mm066"1	C4340-066\$119.96
100mm066"1	C4341-066\$119.96
102mm066"1	C4342-066\$119.96

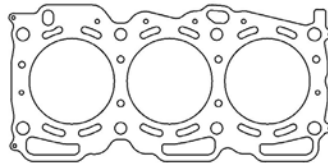

Additional thicknesses available
see page 4



Cometic Gasket - An Exclusive NASCAR Performance Product

TOYOTA

3E 1.5L, 4E 1.3L, 5E 1.5L 1986-98 Corolla, Corona, Starlet, Tercel, Paseo, Sera

Head Gaskets

MLS Head Gaskets

Bore	Thickness	Pkg Qty	Part #	List Price
75mm	.040"	1	C4602-040	\$98.18
76mm	.040"	1	C4603-040	\$98.18



Additional thicknesses available
see page 4

2T 1.6l, 2TC 1.6L, 3T 1.8L, 3TC 1.8L 1970-84 Corolla, 1970-76 Sprinter, 1970-76 Celica,
1970-76 Carina, 1970-84 Corona, 1978-84 Camry

Head Gaskets

MLS Head Gaskets

Bore	Thickness	Pkg Qty	Part #	List Price
87mm	.040"	1	C4258-040	\$93.53
89mm	.040"	1	C4176-040	\$93.53

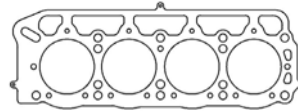

Additional thicknesses available
see page 4

Exhaust Manifold Gasket

Application	Part #	List Price
3TC 1.8L	C4930	\$18.44

4A-GE, 4A-GEC, 4A-GELC 16v 1587cc 1984-92 Corolla, 1989 Carina, 1989 Sprinter,
1984-89 MR2, 1989-89 Celica

Head Gaskets

MLS Head Gaskets

Bore	Thickness	Pkg Qty	Part #	List Price
81mm	.040"	1	C4170-040	\$93.53
83mm	.040"	1	C4166-040	\$93.53

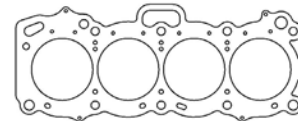

Additional thicknesses available
see page 4

Individual Gaskets

Valve Cover Gasket Set

Application	Part #	List Price
4A-GE 84-92 16v	C4807	\$18.12

Thermostat Gasket

Application	Part #	List Price
4A-GE 84-92 16v	C4809	\$8.30

Intake Gasket Set

Application	Part #	List Price
4A-GE 84-92 16v	C4806	\$20.93

Timing Cover Dust Seal Set

Application	Part #	List Price
4A-GE 84-92 16v	C4811	\$14.76

Exhaust Manifold Gasket

Application	Part #	List Price
4A-GE 84-92 16v .042" AM	C4805-042	\$18.44

Rear Main Seal

Application	Part #	List Price
4A-GE 84-92 16v	C4810	\$10.76

Cam Seal Set

Application	Part #	List Price
4A-GE 84-92 16v 2pcs	C4808	\$11.15

Front Crank Seal

Application	Part #	List Price
4A-GE 84-92 16v	C4931	\$3.35

Valve Stem Seals (sold individually)

Application	Part #	List Price
4A-GE 84-92 16v	3225V	\$1.68

Water Pump Gasket

Application	Part #	List Price
4A-GE 84-92 16v	C4812-039	\$2.12

See page 136 for StreetPro gasket kits



Cometic Gasket - An Exclusive NASCAR Performance Product

TOYOTA

4A-GE, 4A-GEC, 4A-GELC 16v 1587cc 1984-92 Corolla, 1989 Carina, 1989 Sprinter,
1984-89 MR2, 1989-89 Celica

Gasket Kits



TOP END GASKET KIT



Application	Part #	List Price
4A-GE 84-92 16v 81mm Bore	PRO2041T	\$207.55

TOP END GASKET KIT



Application	Part #	List Price
4A-GE 84-92 16v	PRO2041B	\$21.79

4A-GE 1.6L 20v 1587cc 1991-95 Corolla, 1996-01 Carina, 1991-00 Sprinter

Head Gaskets

MLS Head Gaskets

Bore	Thickness	Pkg Qty	Part #	List Price
81mm040"	1	C4604-040	\$93.53
83mm040"	1	C4605-040	\$93.53

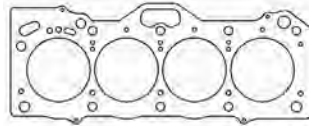

Additional thicknesses available
see page 4

Individual Gaskets

Intake Manifold Gasket

Application	Part #	List Price
4A-GE 20v Small Port	C4932-031	\$10.46

Exhaust Manifold Gasket

Application	Part #	List Price
4A-GE 20v .064" AM.....	C4933-064	\$18.44

1ZZ-FE 1.8L DOHC 1997-08

Head Gaskets

MLS Head Gaskets

Bore	Thickness	Pkg Qty	Part #	List Price
80mm027"	1	C4496-027	\$93.53
82mm027"	1	C4497-027	\$93.53

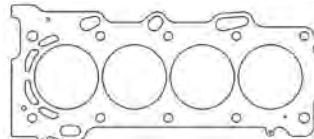

Additional thicknesses available
see page 4

Individual Gaskets

Intake Manifold Gasket

Application	Part #	List Price
1ZZ-FE .032" AFM	C4934-032	\$6.32

Exhaust Manifold Gasket

Application	Part #	List Price
1ZZ-FE 98-02 .030" MLS.....	C4205-030	\$23.74



Cometic Gasket - An Exclusive NASCAR Performance Product

TOYOTA

2ZZ-GE 1.8L DOHC 1795cc: 2000-05 Celica, 2005-06 Corolla, 2003-06 Matrix/Vibe, 2005-11 Lotus Elise, 2006-10 Lotus Exige

Head Gasket

MLX Head Gasket				
Bore	Thickness	Pkg Qty	Part #	List Price
82.5mm	.028"	1	C4962-028	\$115.84

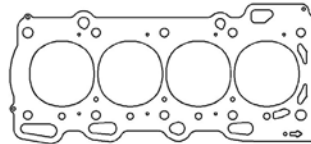

Additional thicknesses available see page 4

3S-GE/3S-GTE 2.0L DOHC Turbo 1998cc 1989-94 Celica, 1990-94 MR2

Head Gasket

MLS Head Gasket				
Bore	Thickness	Pkg Qty	Part #	List Price
87mm	.040"	1	C4314-040	\$93.53

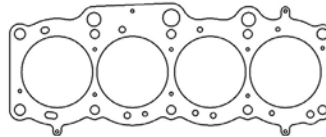

Additional thicknesses available see page 4

Individual Gaskets

Valve Cover Gasket Set		
Application	Part #	List Price
3S-GT/GTE 91-95	C4608	\$37.38

Oil Pan Gasket		
Application	Part #	List Price
3S-GT/GTE 91-95	C4817-062	\$7.57

Intake Manifold Gasket Set		
Application	Part #	List Price
3S-GT/GTE 88-95	C4813	\$20.93

Timing Cover Dust Seal Set		
Application	Part #	List Price
3S-GT/GTE 89-94	C4811	\$14.76

Exhaust Manifold Gasket		
Application	Part #	List Price
3S-GT/GTE 89-95 MLS	C4206-030	\$29.47

Water Pump Gasket		
Application	Part #	List Price
3S-GT/GTE 89-94	C4818-031	\$2.46

Cam Seal Set		
Application	Part #	List Price
3S-GT/GTE 89-95	C4808	\$11.15

Rear Main Seal Set		
Application	Part #	List Price
3S-GT/GTE 89-94	C4815	\$19.70

Valve Stem Seals (sold individually)		
Application	Part #	List Price
3S-GT/GTE 89-95	3225V	\$1.68

Oil Pump Gasket Set		
Application	Part #	List Price
3S-GT/GTE 89-94	C4816	\$9.46

Gasket Kits



TOP END GASKET KIT

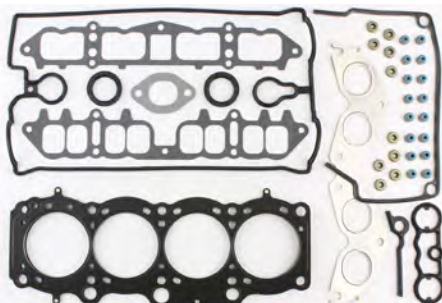

Application	Part #	List Price
3S-GT/GTE 89-94 87mm Bore	PRO2019T	\$163.84

BOTTOM END GASKET KIT



Application	Part #	List Price
3S-GT/GTE 89-94	PRO2019B	\$68.78



Cometic Gasket - An Exclusive NASCAR Performance Product

TOYOTA

3S-GE/3S-GTE 2.0L DOHC Turbo 3rd Gen, ST205 1994-99

Head Gasket

MLS Head Gasket

Bore	Thickness	Pkg Qty	Part #	List Price
87mm040"1	C4606-040\$93.53

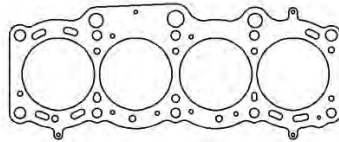

Additional thicknesses available
see page 4

20R 2.2L 1974-81 Corona, 1974-81 Celica, 1974-81 Hi-Lux

Head Gasket

MLS Head Gasket

Bore	Thickness	Pkg Qty	Part #	List Price
92mm040"1	C4268-040\$93.53

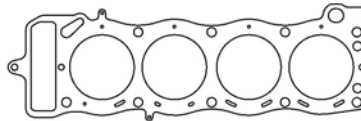

Additional thicknesses available
see page 4

5S-FE 2.2L 2164cc 1990-97 Camry, 1990-97 Celica, 1990-97 MR2

Head Gasket

MLS Head Gasket

Bore	Thickness	Pkg Qty	Part #	List Price
88mm040"1	C4315-040\$93.53

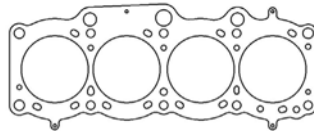

Additional thicknesses available
see page 4

Individual Gaskets

Valve Cover Gasket Set

Application	Part #	List Price
5S-FE 1990-97	C4820\$26.05

Oil Pan Gasket

Application	Part #	List Price
5S-FE 1990-97	C4817-062\$7.57

Intake Manifold Gasket Set

Application	Part #	List Price
5S-FE 1990-97	C4819-046\$3.19

Water Pump Gasket

Application	Part #	List Price
5S-FE 1990-97	C4818-031\$2.46

Exhaust Manifold Gasket

Application	Part #	List Price
5S-FE 1990-97 MLS	C4206-030\$29.47

Rear Main Seal Set

Application	Part #	List Price
5S-FE 1990-97	C4823\$13.04

Cam Seal Set

Application	Part #	List Price
5S-FE 1990-97	C4821\$3.78

Oil Pump Gasket Set

Application	Part #	List Price
5S-FE 1990-97	C4824\$5.50

Valve Stem Seals (sold individually)

Application	Part #	List Price
5S-FE 1990-97	3225V\$1.68

Thermostat Gasket Set

Application	Part #	List Price
5S-FE 1990-97	C4822\$7.00

See page 139 for StreetPro gasket kits



Cometic Gasket - An Exclusive NASCAR Performance Product

TOYOTA

5S-FE 2.2L 2164CC 1990-97 Camry, 1990-97 Celica, 1990-97 MR2

Gasket Kits



TOP END GASKET KIT



Application	Part #	List Price
5S-FE 1990-97 88mm Bore.....	PRO2042T	\$185.69

BOTTOM END GASKET KIT



Application	Part #	List Price
5S-FE 1990-97	PRO2042B	\$33.81

22R/22R-TEC 2.4L 1982-85 Celica, 1981-95 Hi-Lux, 1981-82 Corona, 1984-95 4 Runner

Head Gasket

MLS Head Gasket

Bore	Thickness	Pkg Qty	Part #	List Price
95mm040"	1.....	C4269-040	\$95.53

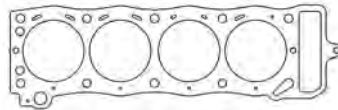

Additional thicknesses available see page 4

Individual Gaskets

Valve Cover Gasket Set

Application	Part #	List Price
22R 2.4L 81-85.....	C4935	\$16.98

Oil Pan Gasket

Application	Part #	List Price
22R 2.4L 81-85.....	C4940	\$13.84

Intake Manifold Gasket Set

Application	Part #	List Price
22R 2.4L 81-85.....	C4936	\$19.02

Water Pump Gasket Set

Application	Part #	List Price
22R 2.4L 81-85.....	C4941	\$6.26

Exhaust Manifold Gaskets

Application	Part #	List Price
22R 2.4L 81-82.....	C4937-064	\$18.01
22R 2.4L 83-84.....	C4938-064	\$18.01
22R 2.4L 85-87.....	C4939-064	\$24.11

Timing Cover Sets

Application	Part #	List Price
22R 2.4L 81-84.....	C4942	\$19.63
22R 2.4L 1985	C4943	\$19.03

Valve Stem Seals (sold individually)

Application	Part #	List Price
22R 2.4L 81-85.....	3157V	\$1.79

Rear Main Seal

Application	Part #	List Price
22R 2.4L 81-85.....	C4944	\$13.46



Cometic Gasket - An Exclusive NASCAR Performance Product

TOYOTA

2RZ-FE 2.4L 1995-04, 3RZ-FE 2.7L 1997-04

Head Gaskets

MLS Head Gaskets

Bore	Thickness	Pkg Qty	Part #	List Price
96mm	.040"	1	C4598-040	\$93.53
97mm	.040"	1	C4245-040	\$93.53

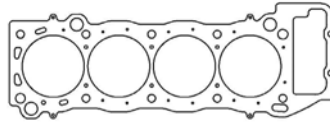

Additional thicknesses available
see page 4

Individual Gaskets

Valve Cover Gasket Set

Application	Part #	List Price
2RZ/3RZ	C4830	\$22.65

Thermostat Gasket Set

Application	Part #	List Price
2RZ/3RZ	C4831	\$8.10

Intake Manifold Gaskets

Application	Part #	List Price
2RZ/3RZ 95-99	C4826-018	\$21.10
2RZ/3RZ 95-99 Plenum	C4827-032	\$21.10
2RZ/3RZ 99-04	C4828-032	\$25.82
2RZ/3RZ 99-04 Plenum	C4829-032	\$25.82

Oil Pan Gasket

Application	Part #	List Price
2RZ/3RZ	C4834	\$5.03

Timing Cover Sets

Application	Part #	List Price
2RZ/3RZ	C4833	\$3.58

Exhaust Manifold Gasket

Application	Part #	List Price
2RZ/3RZ MLS	C4207-030	\$26.99

Water Pump Gasket

Application	Part #	List Price
2RZ/3RZ	C4835-020	\$7.62

Valve Stem Seals (sold individually)

Application	Part #	List Price
2RZ/3RZ	3225V	\$1.68

Rear Main Seal Set

Application	Part #	List Price
2RZ/3RZ	C4832	\$27.65

Gasket Kits



TOP END GASKET KIT



Application	Part #	List Price
2RZ/3RZ 97-04 97mm Bore	PRO2043T	\$256.72

BOTTOM END GASKET KIT



Application	Part #	List Price
2RZ/3RZ 97-04	PRO2043B	\$67.69



Cometic Gasket - An Exclusive NASCAR Performance Product

TOYOTA

2AZ-FE 2.4L DOHC 2002-09 Camry, 2009-11 Matrix, 2009-10 Pontiac Vibe, 2009-11 Corolla ZRS,
2002-09 Solara, 2004-08 RAV4, 2001-08 Highlander, 2005-10 Scion tC, 2008-12 Scion xB

Head Gaskets

MLS Head Gaskets				
Bore	Thickness	Pkg Qty	Part #	List Price
89mm	.027"	1	C4507-027	\$93.53
92mm	.027"	1	C4506-027	\$93.53

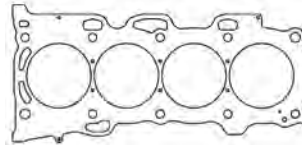

Additional thicknesses available
see page 4

Individual Gaskets

Exhaust Manifold Gasket		
Application	Part #	List Price
2AZ-FE .030" MLS	C4203-030	\$23.74

7M-GE/7M-GTE 3.0L Inline 6 24v 2954cc 1986-92 Supra, 1988-92 Cressida

Head Gaskets

MLS Head Gaskets				
Bore	Thickness	Pkg Qty	Part #	List Price
84mm	.051"	1	C4278-051	\$175.38
86mm	.051"	1	C4275-051	\$175.38

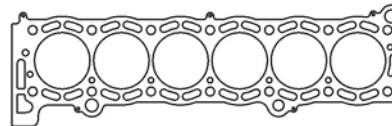

Additional thicknesses available
see page 4

Individual Gaskets

Valve Cover Gasket Set		
Application	Part #	List Price
7M-GE/GTE 86-92	C4838	\$22.65

Thermostat Gasket		
Application	Part #	List Price
7M-GE/GTE 86-92	C4839	\$4.28

Intake Manifold Gasket Set		
Application	Part #	List Price
7M-GE/GTE 86-92	C4837-031	\$15.68

Oil Pan Gasket		
Application	Part #	List Price
7M-GE/GTE 86-92	C4845-062	\$16.69

Exhaust Manifold Gasket		
Application	Part #	List Price
7M-GE/GTE 86-92 MLS	C4208-030	\$26.99

Timing Cover Set		
Application	Part #	List Price
7M-GE/GTE 86-92	C4844	\$3.89

Cam Seal Set		
Application	Part #	List Price
7M-GE/GTE 86-92 2pcs	C4808	\$11.15

Water Pump Gasket Set		
Application	Part #	List Price
7M-GE/GTE 86-92	C4846-031	\$9.73

Valve Stem Seals (sold individually)		
Application	Part #	List Price
7M-GE/GTE 86-92	3225V	\$1.68

Rear Main Seal Set		
Application	Part #	List Price
7M-GE/GTE 86-92	C4843	\$18.32

Throttle Body Gasket		
Application	Part #	List Price
7M-GE/GTE 86-92	C4836-032	\$5.73

Front Crank/Balance Shaft Seals		
Application	Part #	List Price
7M-GE/GTE 86-92 Front Crank	C4945	\$4.97
7M-GE/GTE 86-92 Balance Shaft	C4946	\$5.51



Cometic Gasket - An Exclusive NASCAR Performance Product

TOYOTA

7M-GE/7M-GTE 3.0L Inline 6 24v 2954cc 1986-92 Supra, 1988-92 Cressida

Gasket Kits



TOP END GASKET KIT



Application	Part #	List Price
7M-GE/GTE 86-92 84mm Bore	PRO2020T	\$217.38

BOTTOM END GASKET KIT



Application	Part #	List Price
7M-GE/GTE 86-92.....	PRO2020B	\$51.30

2JZ-GE/GTE 3.0L Inline 6 24v 1993-02 Supra, 1993-95 GS300, 1993-00 SC300

Head Gasket

MLS Head Gasket

Bore	Thickness	Pkg Qty	Part #	List Price
87mm051"	1.....	C4276-051	\$175.38

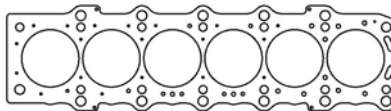

Additional thicknesses available see page 4

Individual Gaskets

Valve Cover Gasket Set

Application	Part #	List Price
2JZ-GE/GTE.....	C4851	\$33.98

Throttle Body Gasket

Application	Part #	List Price
2JZ-GE.....	C4848	\$5.73

Intake Manifold Gasket

Application	Part #	List Price
2JZ-GE.....	C4849	\$101.82

Thermostat Gasket Set

Application	Part #	List Price
2JZ-GE/GTE.....	C4852	\$5.71

Exhaust Manifold Gaskets

Application	Part #	List Price
2JZ-GE .064" AM	C4847-064	\$36.86
2JZ-GTE .030" MLS	C4209-030	\$81.05

Water Pump Gasket

Application	Part #	List Price
2JZ-GE/GTE.....	C4854-031	\$17.94

Cam Seal Set

Application	Part #	List Price
2JZ-GE	C4849	\$101.82

Rear Main Seal

Application	Part #	List Price
2JZ-GE/GTE.....	C4853	\$16.39

Valve Stem Seals (sold individually)

Application	Part #	List Price
2JZ-GE/GTE.....	3225V	\$1.68

See page 143 for additional gaskets



Cometic Gasket - An Exclusive NASCAR Performance Product

TOYOTA

2JZ-GE/GTE 3.0L Inline 6 24v 1993-02 Supra, 1993-95 GS300, 1993-00 SC300

Gasket Kits



TOP END GASKET KIT



Application	Part #	List Price
2JZ-GE 93-98 87mm Bore	PRO2021T	\$359.42

BOTTOM END GASKET KIT



Application	Part #	List Price
2JZ-GE/GTE 93-98.....	PRO2021B	\$68.78

5VZ-FE 3.4L V6 95-99 Tacoma, 95-98 T100, 95-99 4 Runner, 00 Tundra, 96-99 Landcruiser, 00 Hi-Lux

Head Gaskets

MLS Head Gasket - Left Side

Bore	Thickness	Pkg Qty	Part #	List Price
98mm040"	1.....	C4215-040	\$95.53

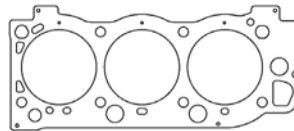

Additional thicknesses available see page 4

MLS Head Gasket - Right Side

Bore	Thickness	Pkg Qty	Part #	List Price
98mm040"	1.....	C4214-040	\$95.53

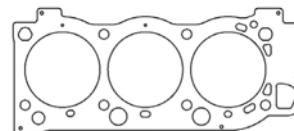

Additional thicknesses available see page 4

1UZ-FE 4.0L 32v V8 w/o VVTi 98-00 GS400, 91-00 LS400, 91-97 SC400

Head Gaskets

MLS Head Gasket - Left Side

Bore	Thickness	Pkg Qty	Part #	List Price
92.5mm051"	1.....	C4137-051	\$98.18

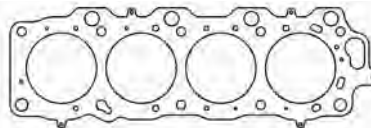

Additional thicknesses available see page 4

MLS Head Gasket - Right Side

Bore	Thickness	Pkg Qty	Part #	List Price
92.5mm051"	1.....	C4136-051	\$98.18

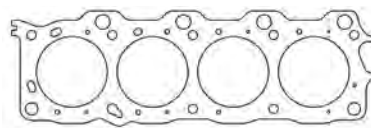

Additional thicknesses available see page 4



Cometic Gasket - An Exclusive NASCAR Performance Product

TOYOTA

2GR-FE 3.5L V6 3456CC 2005 Avalon, 2006 RAV4, 2008 Highlander

Head Gaskets

MLS Head Gasket - Left Side

Bore	Thickness	Pkg Qty	Part #	List Price
94.5mm	.045"	1	C4582-045	\$98.18

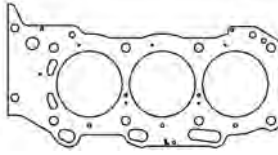

Additional thicknesses available
see page 4

MLS Head Gasket - Right Side

Bore	Thickness	Pkg Qty	Part #	List Price
94.5mm	.045"	1	C4581-045	\$98.18

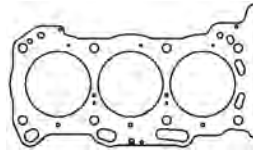

Additional thicknesses available
see page 4

1GR-FE 4.0L V6 2002-Up FJ Cruiser, Landcruiser

Head Gaskets

MLS Head Gasket - Left Side

Bore	Thickness	Pkg Qty	Part #	List Price
95.5mm	.027"	1	C4556-027	\$98.18

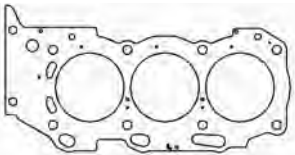

Additional thicknesses available
see page 4

MLS Head Gasket - Right Side

Bore	Thickness	Pkg Qty	Part #	List Price
95.5mm	.027"	1	C4557-027	\$98.18

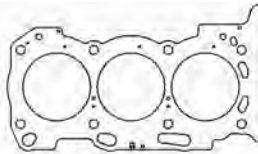

Additional thicknesses available
see page 4

1FZ-FE 4.5L DOHC Inline 6 1995-98 Landcruiser, 1995-98 Lexus 450

Head Gaskets

MLS Head Gasket

Bore	Thickness	Pkg Qty	Part #	List Price
101.5mm	.053"	1	C4530-053	\$210.04

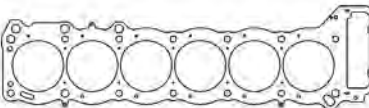

Additional thicknesses available
see page 4

MLX Head Gasket

Bore	Thickness	Pkg Qty	Part #	List Price
101.5mm	.040"	1	C4611-040	\$234.46

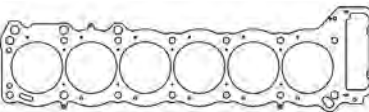

Additional thicknesses available
see page 4



Cometic Gasket - An Exclusive NASCAR Performance Product

TOYOTA

2UZ-FE 4.7L 32v V8 1998 Landcruiser, 2004 GX470, 2004 4 Runner, 2001-04 Tundra, 2001-04 Sequoia, 1998-00 LX470

Head Gaskets

MLS Head Gaskets - Left Side

Bore	Thickness	Pkg Qty	Part #	List Price
92mm	.040"	1	C4358-040	\$98.18
98mm	.040"	1	C4212-040	\$98.18

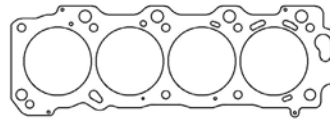

Additional thicknesses available see page 4

MLS Head Gaskets - Right Side

Bore	Thickness	Pkg Qty	Part #	List Price
92mm	.040"	1	C4357-040	\$98.18
98mm	.040"	1	C4211-040	\$98.18

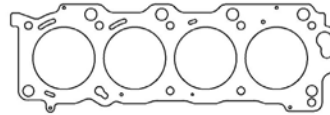

Additional thicknesses available see page 4

PH11 Race V8

Head Gaskets

MLS Head Gasket - Left Side

Bore	Thickness	Pkg Qty	Part #	List Price
4.200"	.040"	1	C5584-040	\$115.84

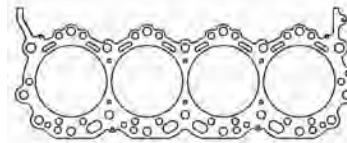

Additional thicknesses available see page 4

MLS Head Gasket - Right Side

Bore	Thickness	Pkg Qty	Part #	List Price
4.200"	.040"	1	C5583-040	\$115.84

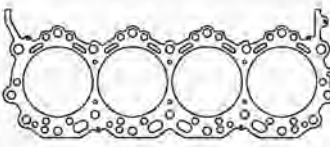

Additional thicknesses available see page 4

TRIUMPH

1966-74 Spitfire 1500cc

Head Gasket

Copper Head Gasket

Bore	Thickness	Pkg Qty	Part #	List Price
74mm	.043"	1	C4153-043	\$94.07

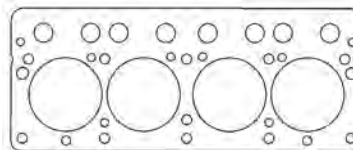

Additional thicknesses available see page 4

1961-65 TR4 2138cc Pushrod

Head Gasket

CFM-20 Head Gasket

Bore	Thickness	Pkg Qty	Part #	List Price
88mm	.043"	1	C4152-043	\$81.80

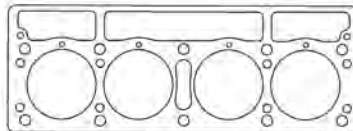

Additional thicknesses available see page 4

1969-71 TR6 2498cc Inline 6 Pushrod

Head Gasket

Copper Head Gasket

Bore	Thickness	Pkg Qty	Part #	List Price
76mm	.043"	1	C4154-043	\$94.07

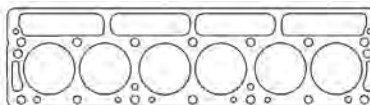

Additional thicknesses available see page 4



Cometic Gasket - An Exclusive NASCAR Performance Product

TVR

Speed 6 3.6/4.0L 1999-06 Tuscon, 1996-06 Cerbera, 2002-06 Tamora, 2002-06 T350, 2004-06 Sagaris

Head Gaskets

MLS Head Gasket

Bore	Thickness	Pkg Qty	Part #	List Price
96.5mm060"1	C4527-060\$228.51

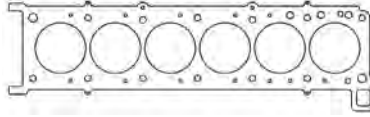

Additional thicknesses available
see page 4

VAUXHALL/OPEL

C16XE, X16XE/X16XEL, Y16XE 1994-98 Astra, 1993-94 Corsa B GSI, 1994-00 Tigra 16v

Head Gasket

MLS Head Gasket

Bore	Thickness	Pkg Qty	Part #	List Price
82mm051"1	C4257-051\$93.53

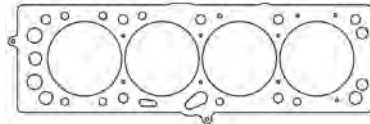

Additional thicknesses available
see page 4

20XE/C20XE/X20LET 1992-97 Calibra Turbo, 1987-91 Kadett E 16v, 1993-95 Vectra A Turbo

Head Gasket

MLS Head Gasket

Bore	Thickness	Pkg Qty	Part #	List Price
88mm051"1	C4216-051\$93.53

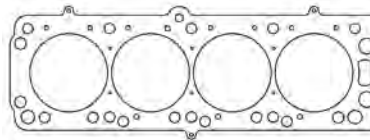

Additional thicknesses available
see page 4

MLX Head Gasket

Bore	Thickness	Pkg Qty	Part #	List Price
88mm050"1	C4960-050\$115.84

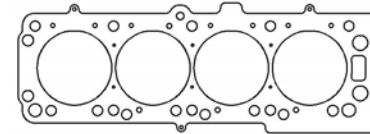

Additional thicknesses available
see page 4

CIH/E, CIH/S, CIH/S/E 2.0L 1983-88 Manta B, 1978-81 Ascona, 1976-80 Rekord, 1983-84 Monza, 1977-79 Kadett,

Head Gasket

MLS Head Gasket

Bore	Thickness	Pkg Qty	Part #	List Price
97mm051"1	C4512-051\$158.15

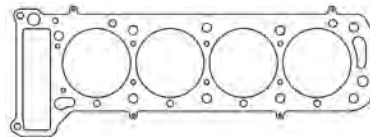

Additional thicknesses available
see page 4

VOLKSWAGEN/AUDI

1.4L 1390cc DOHC TFSI 2007+: BMY, BLG

Head Gaskets

MLX Head Gasket

Bore	Thickness	Pkg Qty	Part #	List Price
77mm032"1	C4980-032\$115.84

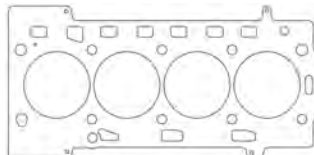

Additional thicknesses available
see page 4

NEW!

Exhaust Manifold Gasket Sets

Application	Part #	List Price
1.4L DOHC 16v MLS	C4975-030\$21.60



Cometic Gasket - An Exclusive NASCAR Performance Product

VOLKSWAGEN/AUDI

1.8L

AGB, 2H, GX, HT, JH, JN, MZ, PG, PF, RD, RV, PL 2.0L: 9A - Golf Mk2/Mk3, Jetta Mk2/Mk3, Passat B2/B3/B4, Audi 80/100, Seat Ibiza Mk2

Head Gaskets

MLS Head Gaskets

Bore	Thickness	Pkg Qty	Part #	List Price
83mm	.051"	1	C4247-051	\$95.53
85mm	.051"	1	C4246-051	\$95.53

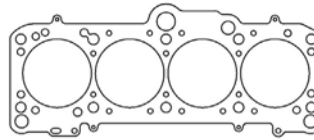

Additional thicknesses available see page 4

Individual Gaskets

Exhaust Manifold Gasket Sets

Application	Part #	List Price
1.8L 8v MLS - 4pcs	C4163-030	\$36.17
1.8L 16v MLS - 4pcs	C4210-030	\$36.17

1.8L Turbo 1998-06

AEB, AGU, AJH, APH, ARX, ARZ, ATW, AUM, AVC, AWD, AWL, AWT, AWW, BJX, BKF, BKV, CFMA, AYP, CED, AMB, AWM, AJQ, APP, ARY, ATC, AUQ, AWP, BEK, BNU, BEX, BVR, AMU, AMK, BAM, BEA

Head Gaskets

MLS Head Gaskets

Bore	Thickness	Pkg Qty	Part #	List Price
82mm	.051"	1	C4558-051	\$93.53
85mm	.051"	1	C4559-051	\$93.53

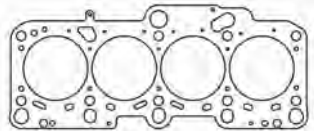

Additional thicknesses available see page 4

2.0L TFSI 16v DOHC

Golf GTI 2004-Up, A3, A4, A6, Jetta, Passat 2005-Up, TT, EOS 2006-Up, Seat Leon 2005-Up (AXX, BPY, BWA, BPJ, BUL, BWE, BRC, BWT, BYK)

Head Gasket

MLS Head Gasket

Bore	Thickness	Pkg Qty	Part #	List Price
83.5mm	.051"	1	C4541-051	\$93.53

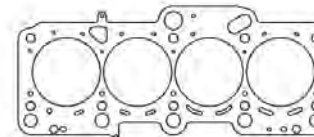

Additional thicknesses available see page 4

NEW!

Exhaust Manifold Gasket Sets

Application	Part #	List Price
2.0L DOHC 16v MLS 2005-14	C4972-030	\$21.60

2.0L 16v DOHC 2008-11(chain driven): A3, A4, A6, A3, A4, A5, Q5, TT, Jetta

Head Gaskets

NEW!

MLS Head Gasket

Bore	Thickness	Pkg Qty	Part #	List Price
82.5mm	.040"	1	C4976-040	\$93.53
84mm	.040"	1	C4977-040	\$93.53

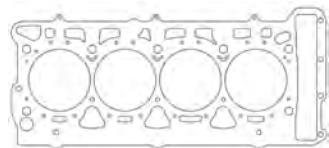

Additional thicknesses available see page 4

Exhaust Manifold Gasket Sets

Application	Part #	List Price
2.0L DOHC 16v MLS 2005-14	C4972-030	\$21.60



Cometic Gasket - An Exclusive NASCAR Performance Product

VOLKSWAGEN/AUDI

2.0L 16v DOHC 2012-Present (chain driven): A1, A3, A4, A5, Q3, Q5, TT

Head Gaskets

NEW!

MLS Head Gasket

Bore	Thickness	Pkg Qty	Part #	List Price
83mm040"1	C4978-040\$93.53
84mm040"1	C4979-040\$93.53

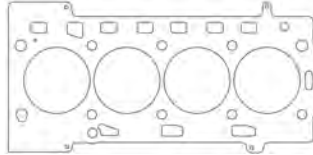

Additional thicknesses available
see page 4

Exhaust Manifold Gasket Sets

Application	Part #	List Price
2.0L DOHC 16v MLS 2005-14.....	C4972-030\$21.60

3.2L VR6 24v 2004-09: Golf Mk4 R32

Head Gaskets

NEW!

MLS Head Gasket

Bore	Thickness	Pkg Qty	Part #	List Price
83mm030"1	C4968-030\$110.44

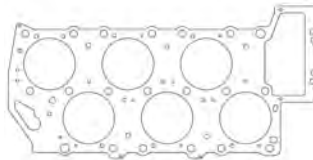

Additional thicknesses available
see page 4

VOLVO

B18A/B/D 1.8L 1961-68, B20A/B/E/F 2.0L 1969-81

Head Gasket

MLS Head Gasket

Bore	Thickness	Pkg Qty	Part #	List Price
86mm045"1	C4287-045\$116.88
90mm045"1	C4288-045\$116.88
92mm045"1	C4289-045\$116.88

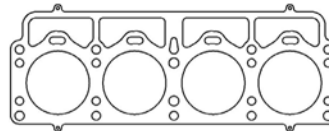

Additional thicknesses available
see page 4

B19A/E/ET 2.0L 1976-84, B20E/F/K/ET/FT 2.0L 1985-95, B21E/F/T/FT 2.1L 1975-85

Head Gasket

NEW!

MLS Head Gasket

Bore	Thickness	Pkg Qty	Part #	List Price
92mm045"1	C4498-045\$116.88
92mm098"1	C4498-098\$116.88

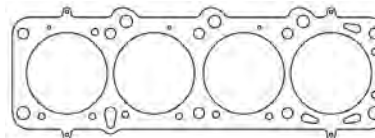

Additional thicknesses available
see page 4

B23AE/E/F/FT 2.3L 1978-84, B230A/E/F/FT/K 2.3L 1985-98, B243F 1989-95

Head Gasket

MLS Head Gasket

Bore	Thickness	Pkg Qty	Part #	List Price
97mm045"1	C4499-045\$116.88

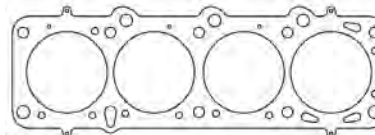

Additional thicknesses available
see page 4



Cometic Gasket - An Exclusive NASCAR Performance Product

MLS Exhaust Manifold Gaskets

- Designed for extreme cylinder pressures
- Maintains a torque set
- Resists corrosion, will not burn through or push out
- Withstands different combinations of cylinder head & exhaust manifold materials
- No sealants are required



Domestic Exhaust Gaskets

Description	Material	Pkg Qty	Part#	List
CHRYSLER / DODGE				
318, 340 & 360				
1.310" x 1.640" Port	MLS .030"	2	C5901-030	\$44.28
361, 383, 400, 413, 426 & 440				
1.780" x 1.460" Port	MLS .030"	2	C5902-030	\$47.91
426 Hemi				
1.840" x 1.890" Port Stock	MLS .030"	2	C5965-030	\$40.93
2.310" x 2.810" Port Top Fuel	MLS .030"	2	C5903-030	\$46.44
5.7L Hemi V8				
1.460" x 1.390" Port	MLS .030"	2	C5854-030	\$38.55
6.1L Hemi V8				
2.082" x 1.508" Port	MLS .030"	2	C5872-030	\$41.04
Viper V10				
Gen I 1992-96	MLS .030"	2	C5679-030	\$33.15
Gen II 1996-02	MLS .020"	2	C5825-020	\$33.15
Gen III 2003-07	MLS .030"	2	C5865-030	\$33.15
Gen IV 2008-12	MLS .040"	2	C15150-040	\$53.96
CUMMINS				
5.9L 12V I6 Diesel 92-97	MLS .040"	2	C5725-040	\$49.74
5.9L 24V / Common Rail 98-08	MLS .040"	2	C5726-040	\$49.74
FORD				
289, 302 & 351				
1.120" x 1.480" Port Square	MLS .030"	2	C5898-030	\$41.04
1.127" x 1.750" Port Oval	MLS .030"	2	C5899-030	\$41.04
All Yates Head 3 Piece Spring Steel	MLS .040"	8	C5665-040	\$38.55
332 & 390				
1.560" x 2.320" Port	MLS .030"	1	C5922-030	\$47.60
4.6L DOHC & SOHC, 5.4L SOHC				
4.6L / 5.4L 3V Head	MLS .030"	2	C5852-030	\$39.03
4.6L / 5.4L 3V Head D-Ports	MLS .030"	2	C5997-030	\$39.03
4.6L SOHC 1991-01, 5.4L Triton 99-Up	MLS .030"	2	C5853-030	\$36.17
4.6L / 5.4L DOHC 93-99	MLS .030"	2	C5012-030	\$40.99
5.0L Modular V8 2011	MLS .030"	2	C5392-030	\$46.53
5.4L Shelby Mustang 2007	MLS .030"	2	C5805-030	\$45.65
6.2L "BOSS" V8 2010+	MLS .030"	2	C5041-030	\$58.38
429 & 460				
1.250" x 2.080" Oval Port	MLS .030"	2	C5900-030	\$45.36
1.550" x 2.350" Oval Port	MLS .030"	2	C5998-030	\$41.04
RACE				
JC50 500ci - Pro Stock	MLS .030"	2	C5257-030	\$58.38
FR9 V8	MLS .030"	2	C15107-030	\$58.38
DIESEL				
6.0/6.4L Powerstroke	MLS .300"	2	C5089-030	\$49.74
GM				
V8 Small Block 262, 265, 283, 302, 307, 327, 350, 400 & LT1				
1.400" Square Port	MLS .030"	2	C5548-030	\$41.04
1.500" Round Port	MLS .030"	2	C5891-030	\$41.04
1.450" x 1.480" Port	MLS .030"	2	C5892-030	\$41.04
1.625" Round Port	MLS .030"	2	C5893-030	\$42.13
1.450" x 1.600" Port	MLS .030"	2	C5894-030	\$42.13
LT1 1.520" x 1.510" Port	MLS .030"	2	C5895-030	\$43.21
Brodix 12B Raised D Port	MLS .030"	2	C5927-030	\$43.21
Brodix / Weldtech 12 x 12 D Port	MLS .030"	2	C5928-030	\$43.21
GM/Brodix 13 Degree 4.4/4.5" Spacing	MLS .030"	2	C5039-030	\$38.07
Brodix/All Pro 286	MLS .030"	2	C5040-030	\$38.07
SB2 Race				
1.500" x 1.600"	MLS .065"	2	C5552-065	\$35.05
SB2	MLS .030"	2	C5836-030	\$55.59
Big Block				
1.920" Round Port	MLS .030"	2	C5896-030	\$44.28
2.000" Round Port	MLS .030"	2	C5349-030	\$44.28
2.130" Round Port	MLS .030"	2	C5996-030	\$44.28
2.200" Round Port	MLS .030"	2	C5350-030	\$44.28
2.250" Round Port	MLS .030"	2	C5251-030	\$44.28
1.850" x 1.900" Port	MLS .030"	2	C5897-030	\$44.28
Mercury Big Block 1050	MLS .051"	2	C5820-051	\$70.07
Mercury Marine 525/552 EFI	MLS .051"	2	C15364-030	\$70.07

Description	Material	Pkg Qty	Part#	List
GM				
LS Series V8				
LS Series V8	MLS .030"	2	C5818-030	\$36.17
LS7 D-Port 06-14	MLS .030"	2	C5073-030	\$36.17
GEN V LT1 6.2L 1.920" Port	MLS .021"	2	C5020-021	\$50.10
DIESEL				
6.6L Duramax 01-04	MLS .030"	2	C15042-030	\$50.10
Pontiac V8 326, 350, 400, 421, 428 & 455 D Port	MLS .030"	2	C5905-030	\$44.28
OLDS				
330, 350, 400, 403 & 455				
1.450" x 1.920" Port	MLS .030"	2	C5904-030	\$44.28
UNIVERSAL Header Collector				
3.000" Dia. x 3.875" Bolt Circle	MLS .030"	1	C5907-030	\$19.41

Import Exhaust Gaskets

Description	Material	Pkg Qty	Part#	List
GM				
Ecotec 2.2L - 1.720" x 1.090" 00-Up	MLS .030"	1	C4150-030	\$23.74
HONDA				
All B Series - 1.850" x 1.340" 94-01	MLS .030"	1	C4151-030	\$19.41
H22A1/A2/A4 - 1.770" x 1.380" 92-01	MLS .030"	1	C4155-030	\$29.15
F20C1/C2 - 2.030" x 1.730" 00-Up	MLS .030"	1	C4159-030	\$23.74
K20A1/A3 - 1.820" x 1.540" 01-04	MLS .030"	1	C4160-030	\$23.74
K20A2 - 1.975" x 1.730" 02-06	MLS .030"	1	C4162-030	\$23.74
D15/16 - 1.860" x 1.390" 92-00	MLS .030"	1	C4164-030	\$23.74
MAZDA				
B6 16V - 1.765" x 1.020" 89-93	MLS .030"	1	C4165-030	\$32.36
FS-DE - 2.045" x 1.375" 91-03	MLS .030"	1	C4171-030	\$26.99
MITSUBISHI				
4G63T/4G64 - 2.287" x 1.615" 89-99	MLS .030"	1	C4199-030	\$23.74
420A - 2.040" x 1.100" 95-98	MLS .030"	1	C4161-030	\$23.74
NISSAN				
VK56XD 2010-16	MLS .030"	1	C4959-030	\$58.40
VK56DE 2004-09	MLS .030"	1	C4961-030	\$58.40
CA18 DOHC - 1.621" x 1.232"	MLS .030"	1	C4523-030	\$58.40
SR20DE/T - 2.050" x 1.580" 91-02	MLS .030"	1	C4200-030	\$29.15
KA24DE - 1.575" Square 91-98	MLS .030"	1	C4201-030	\$29.15
RB26 - 1.665" x 1.420" 89-02	MLS .030"	2	C4202-030	\$26.99
RB20/RB25 - 1.340" x 1.575"	MLS .030"	1	C4177-030	\$26.99
SCION				
2AZ-FE 2.4L - 1.890" Round 01-Up	MLS .030"	1	C4203-030	\$23.74
SUBARU				
All EJ Motors - 1.825" Round 93-Up	MLS .030"	2	C4204-030	\$17.92
TOYOTA				
1ZZFE - 1.732" Round 98-02	MLS .030"	1	C4205-030	\$23.74
3S-GTE/5S-FE - 1.690" x 1.415" 89-97	MLS .030"	1	C4206-030	\$29.47
2RZ/3RZ-FE - 1.730" x 1.460" 95-Up	MLS .030"	1	C4207-030	\$26.99
7MGTE - 1.412" Round 87-92	MLS .030"	1	C4208-030	\$26.99
2JZGTE - 1.600" x 1.220" 93-Up	MLS .030"	2	C4209-030	\$81.04
VW/AUDI				
2.0L 05-14	MLS .030"	4	C4972-030	\$21.60
1.4L 07-Up	MLS .030"	4	C4975-030	\$21.60
2.0L - 1.525" Round 85-96	MLS .030"	4	C4210-030	\$36.17



Cometic Gasket - An Exclusive NASCAR Performance Product

Valve Stem Seals

Available for most applications ranging from automotive to off road dirt bikes. Valve stem seals are defined first by the actual measurement of the valve stem OD itself then by the guide OD. Proper seal height and width will be determined by valve spring clearance. Sold in packs of sixteen.



Umbrella

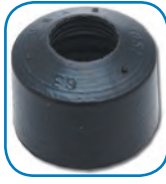

Positive All Rubber



Positive Ring & Spring

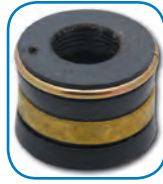

Positive Ring & Band



O-Ring



Metal Jacket



Metal Jacket "Hat"

Metric Valve Stem

Part #	Stem OD	Guide OD	Height	OD	Type / Matl.	Retail
3154V-16	8.0mm	12.0mm	9.6mm	15.5mm	Metal Jacket/Viton	\$33.25
3158V-16	6.0mm	10.7mm	11.5mm	13.8mm	Metal Jacket/Viton	\$23.13
3159V-16	6.0mm	11.75mm	15.0mm	14.6mm	Metal Jacket/Viton	\$23.13
3162V-16	7.0mm	15.0mm	14.0mm	14.3mm	Metal Jacket/Viton	\$40.27
3163V-16	5.5mm	11.8mm	12.0mm	14.8mm	Metal Jacket/Viton	\$38.39
3164V-16	8.0mm	12.3mm	12.0mm	17.0mm	Ring & Band/Viton	\$32.73
3168V-16	7.5mm	14.0mm	13.0mm	16.8mm	Metal Jacket/Viton	\$39.99
3169V-16	5.5mm	12.0mm	13.8mm	14.5mm	Metal Jacket/Viton (no int rubber)	\$25.88
3170V-16	5.0mm	11.0mm	10.0mm	12.85mm	Metal Jacket/Viton	\$21.42
3172V-16	6.0mm	9.8mm	10.0mm	13.2mm	Metal Jacket/Viton	\$46.10
3173V-16	5.5mm	11.8mm	12.0mm	14.75mm	Metal Jacket/Viton	\$32.91
3225V-16	6mm	11mm	9.3mm	13.4mm	Metal Jacket/Viton	\$25.50
3174V-16	8.5mm	12.5mm	2.0mm	11.9mm	O-ring/Viton	\$6.17
3175V-16	5.5mm	9.5mm	11.4mm	12.75mm	Metal Jacket/Viton	\$23.13
3176V-16	5.0mm	10.6mm	11.6mm	14.15mm	Metal Jacket/Viton	\$36.50
3177V-16	6.0mm	12.0mm	10.0mm	13.7mm	Metal Jacket/Viton	\$38.39
3180V-16	5.0mm	10.8mm	18.3mm	16.9mm	Metal Jacket (Hat)/Viton	\$32.49
3181V-16	5.5mm	11.6mm	20.2mm	17.2mm	Metal Jacket (Hat)/Viton	\$44.56
3182V-16	5.0mm	11.8mm	21.0mm	17.15mm	Metal Jacket (Hat)/Viton	\$47.99
3262V-16	7.0mm	11mm	9.5mm	14.4mm	Metal Jacket/Viton	\$27.25
3264V-16	5.0mm	11mm	8mm	13.4mm	Metal Jacket EXH/Viton	\$28.80
3265V-16	5.0mm	11mm	8mm	13.4mm	Metal Jacket INT/Viton	\$77.13
3516P-16	8.0mm	0.492	0.470	0.616	Metal Jacket/Polyl.	\$26.56

11/32" Valve Stem

Part #	Stem OD	Guide OD	Height	OD	Type / Matl.	Retail
3012V1-16	11/32	0.500	0.540	0.640	Ring & Band/Viton	\$31.36
3013N1-16	11/32	0.520	0.470	0.690	Positive 2-Ring/Nitrile	\$7.02
3014N1-16	11/32	0.530	0.485	0.710	Ring & Band/Nitrile	\$7.71
3024V1-16	11/32	0.530	0.485	0.710	Ring & Band/Viton	\$33.08
3066V1-16	11/32	0.563	0.470	0.690	Ring & Band/Viton	\$30.51
3188V-16	11/32	0.500	0.531	0.623	Metal Jacket/Viton	\$28.97
3192V-16	11/32	0.562	0.485	0.677	Ring & Band/Viton	\$31.19
3223V-16	11/32	0.472	0.435	0.677	Metal Jacket/Viton	\$27.59
3228V-16	11/32	0.530	0.527	0.674	Metal Jacket/Viton	\$32.73
3245V-16	11/32	0.583	0.400	0.740	Metal Jacket/Viton	\$25.02

3/8" Valve Stem

Part #	Stem OD	Guide OD	Height	OD	Type / Matl.	Retail
3017N1-16	3/8	0.623	0.470	0.790	Positive-2-Ring/Nitrile	\$15.33
3050V-16	3/8	0.750	0.830	0.875	Umbrella Seal/Viton	\$31.54
3185T-16	3/8	0.562	0.415	0.66	Teflon Steel Body/Teflon	\$26.22
3195V-16	3/8	0.500	0.531	0.623	Metal Jacket/Viton	\$27.59
3196V-16	3/8	0.530	0.516	0.677	Metal Jacket/Viton	\$31.19
3197V-16	3/8	0.562	0.516	0.661	Metal Jacket/Viton	\$27.59
3198V-16	3/8	0.625	0.531	0.742	Metal Jacket/Viton	\$31.19

1/4" Valve Stem

Part #	Stem OD	Guide OD	Height	OD	Type / Matl.	Retail
3184V-16	1/4	0.435	0.392	0.531	Metal Jacket/Viton	\$27.59
3232V-16	1/4	0.476	0.517	0.562	Metal Jacket/Viton (no int rubber)	\$25.88
3258V-16	1/4	0.476	0.646	1.106	Metal Jacket (Hat)/Viton	\$16.96
3259V-16	1/4	0.48	0.794	1.106	Metal Jacket (Hat)/Viton	\$17.14

5/16" Valve Stem

Part #	Stem OD	Guide OD	Height	OD	Type / Matl.	Retail
3057V-16	5/16	0.438	0.445	0.600	Ring & Band/Viton	\$47.99
3060V-16	5/16	0.562	0.461	0.710	Ring & Band/Viton	\$43.02
3061V-16	5/16	0.562	0.461	0.710	Ring & Band/Viton	\$43.02
3064V-16	5/16	0.563	0.580	0.712	Metal Jacket/Viton	\$61.70
3222V-16	5/16	0.514	0.403	0.610	Metal Jacket/Viton	\$27.59
3235V-16	5/16	0.531	0.516	0.677	Metal Body/Viton	\$32.91
3236V-16	5/16	0.491	0.531	0.623	Metal Body/Viton	\$32.91
3237V-16	5/16	0.476	0.517	0.562	Metal Body/Viton (no int rubber)	\$25.88
3216V-16	5/16	0.562	1.085	1.3888	Metal Jacket (Hat)/Viton	\$50.76

Misc. Valve Stem

Part #	Stem OD	Guide OD	Height	OD	Type / Matl.	Retail
3199V-16	276	0.476	0.517	0.562	Metal Jacket/Viton (no int rubber)	\$25.88
3240V-16			0.975	0.970	Metal Jacket (Hat)/Viton	\$60.68
3255V-16	0.287	0.49	0.887	1.185	Metal Jacket (Hat) INT/Viton	\$24.34
3256V-16	0.287	0.49	0.887	1.185	Metal Jacket (Hat) EXH/Viton	\$24.34
3260V-16	0.281	0.53	1.035	1.372	Metal Jacket (Hat)/Viton	\$64.27
3261V-16	0.281	0.53	1.14	1.255	Metal Jacket (Hat)/Viton	\$41.82
3214V-16	0.265	0.500	555	645	Metal Jacket /Intake	\$38.89
3215V-16	0.265	0.500	555	638	Metal Jacket /Exhaust	\$50.76
3217V-16	0.265		1.020	1.000	Metal Jacket (Hat)/Viton	\$71.03
3218V-16	0.265	0.500	635	1.126	Metal Jacket / Intake/Yellow	\$32.14
3219V-16	0.265	0.500	635	645	Metal Jacket / Exhaust/Green	\$32.14
3246V-16	0.198	0.334	390	482	Metal Jacket / Viton	\$23.73
3257V-16	0.204		555	645	Metal Jacket /	\$38.48



Cometic Gasket - An Exclusive NASCAR Performance Product

Miscellaneous Gaskets & Seals

2 Pc Viton Rear Main Seals

Description	Part #	List	Description	Part #	List
Buick W / Side Rails 196,231,252	C5707	\$18.27	Chrysler 360	C5684	\$29.41
Chevy 283-400	C5680	\$24.54	Chrysler 361-440 & Hemi	C5686	\$33.57
Chevy BB 396-454	C5682	\$29.51	Ford 289,302	C5688	\$28.22
Chrysler 273,318,340	C5683	\$31.95	Ford 351C,M,351W	C5689	\$29.91

Timing Cover Gasket Sets

Description	Part #	List	Description	Part #	List
AMC 290-401 V8 66-88	C5046	\$16.98	CHRYSLER MAGNUM V6/V8 97-98	C5060	\$22.65
AMC 4/6 CYL 2.5/3.8/4.0/4.2L 65-06	C5047	\$16.98	CHRYSLER LA SMALL BLOCK V8 64-91	C5061	\$28.31
BUICK V6/SMALL V8 66-87 (Rope Seal)	C5048	\$22.65	CHRYSLER 5.7/6.1L HEMI 03-UP	C5202	\$39.64
BUICK V6/SMALL V8 66-87 (Radial Seal)	C5049	\$16.98	CHRYSLER WEDGE/426 HEMI V8 58-79	C5062	\$28.31
BUICK 400/430/455 V8 67-74	C5050	\$16.98	CHRYSLER EARLY HEMI V8 55-59	C5063	\$28.31
GM SMALL BLOCK V8/V6 75-95 (Thick Front Seal)	C5051	\$16.98	FORD SMALL BLOCK V8 62-78	C5064	\$24.91
GM SMALL BLOCK V8 57-74 (Thin Front Seal)	C5052	\$16.98	FORD SMALL BLOCK V8 79-97	C5065	\$24.91
GM 4/6 CYL 151/230/250/192 63-89	C5053	\$16.98	FORD 351C/351M/400 V8 70-81	C5066	\$22.65
GM SMALL BLOCK LT1 V8 92-94	C5054	\$16.98	FORD 352/360 FE V8 58-60	C5067	\$22.65
GM SMALL BLOCK LT1 V8 92-97	C5055	\$22.65	FORD 332-428 FE V8 61-71	C5068	\$22.65
GM SMALL BLOCK LS V8 98-11	C5056	\$39.64	FORD 429/460 BIG BLOCK 68-85	C5069	\$22.65
GM BIG BLOCK V8 65-95	C5057	\$22.65	OLDS 260-455 V8 64-90	C5070	\$22.65
GM BIG BLOCK V8 96-00	C5058	\$16.98	PONTIAC 265-455 V8 63-81	C5071	\$28.31
CHRYSLER MAGNUM V6/V8 92-96	C5059	\$22.65			

Engine Crankshaft Seals for Wet & Dry Sump Applications

Description	Signal Part #	TTS Part #	Cometic Part #	List	Description	Signal Part #	TTS Part #	Cometic Part #	List
JESEL Small Block Crank B/Drive F.C.	86587	T-13527	C5376	\$45.00	Ford Rear Crankseal W/302 Crank	85742	T-13584	C5384	\$97.85
JESEL Big Block Crank B/Drive F.C.	86622	T13553 Rev. B	C5377	\$61.07	Ford Rear Crankseal 302	13610	T-13610	C5385	\$77.20
JESEL (SEL 38000) Cam	86586	T13561 Rev. B	C5435	\$49.42	Ford Front Crankseal 302 & 351	85338	T-13690	C5386	\$53.87
Aluminum GM Sprint 400 Main	86410	T-13675	C5672	\$83.25	Ford R.R. Crankseal 351	85339	T-14053	C5391	\$73.45
Chevy Small Block Rear Split Seal	86625	T-13675-DL	C5379	\$58.66	Ford 351 Front Crank Yates Drive	85741	T-14276	C5490	\$94.56
Chevy Big Block Rear Split Seal	86665	T-13676	C5381	\$51.70	GM Small Block Front Crankseal	86990	T-13852	C5378	\$61.87
Dodge R5 Small Block Rear Crank	14255	T-14255	C5396	\$63.30					

Fuel Cell Gasket Kit

Description	Part #	List
Vent Neck Gasket .059" CFM20	C5507	\$50.45
8 Bolt Vent Gasket .059" CFM20		
Fill Plate Gasket .059" CFM20		

ATI Damper Re-build Viton O-Rings

Description	Part #	List
6" Damper Rebuild Kit (3-Ring)	C5393	\$85.00
7" Damper Rebuild Kit (3-Ring)	C5486	\$85.00
6" Damper Rebuild Kit (4-Ring)	C5632	\$106.25



Sheet Materials

Part #	Description	List
C15180HTS	10" X 10" X .060" HTS	\$14.99
C15346FC	24" X 6" X .060" FC	\$12.99
C15346HTS	24" X 6" X .060" HTS	\$22.99
C15346TNG	24" X 6" X .060" TNG	\$18.59
C15354F	36" X 9" X .031" FIBER	\$14.95
C15358TNG	12" X 12" X .060" TNG	\$12.99
C15384	10" X 26" X 1/16" CORK/RUBBER (w/Cutting Tool)	\$10.98
C15385	10" X 26" X 1/32" FIBER (w/Cutting Tool)	\$10.98



Promotional Items

Part #	Description	Price
DC15	Package Decal 5.25" x 1.75"	\$.05
DC06	Decal Sheet 5.5" x 8.5"	\$1.00
DC10	Embroidered Patch 2" x 5"	\$2.00
DC04	Trailer Decal 6" x 19"	\$4.00
DC03	Decal 3.125" x 9"	\$1.00
DC11	Banner 3' x 8'	\$10.00
DC17	StreetPro Decal 1.625" x 9"	\$.50
DC13	Dealer Open House Kit	\$61.99
	(100) DC01, (2) DC04, (2) DC11, (2) DC12, (10) 40% Off Retail Certificates, (25) Catalogs	
DC12	Adjustable Embroidered Hat	\$10.00



Klotz Synthetic Lubricants are designed and engineered to be the best lubricants in the motorsports industry. Race tested and formulated for all engine types, Klotz offers a full line of Estorlin Synthetic Racing Oils, Power Additives, and Aerosols needed to keep you engine protected and performing at an optimal level.

Racers, engine builders, and performance enthusiasts around the world rely on Klotz to get them to the checkered flag. Be Fast, Be First with Klotz Synthetic Lubricants. For more information, Tech Sheets, or MSDS Sheets please visit www.klotzlube.com



ESTORLIN® RACING PERFORMANCE SYNTHETIC ENGINE LUBRICANT

Part#	Desc.	Price
KE-925	5W/20 Qt.	\$13.99
KE-930	10W/30 Qt.	\$13.99
KE-935	5W/30 Qt.	\$13.99
KE-940	10W/40 Qt.	\$13.99
KE-950	20W/50 Qt.	\$13.99
KE-954	15W/40 Qt.	\$13.99
KE-955	15W/50 Qt.	\$13.99
KE-915	15W/55 Qt.	\$13.99

Also available by the Case & 5 Gallon Pail



UPLON® FUEL LUBE

- Provides upper cylinder and fuel pump lubrication
- Blends with methanol alcohol, ethanol, nitromethane and gasoline
- Maintains constant fuel pressure

Part#	Desc.	Price
KL-106	Pint	\$8.51
KL-107	Quart	\$14.36

Also available by the Case



ESTORLIN® FREE-GEAR® HYPOID SYNTHETIC GEAR LUBRICANT

Part#	Desc.	Price
KE-960	75W/75 Qt.	\$15.03
KE-970	75W/80 Qt.	\$15.03

Also available by the Case & 5 Gallon Pail



ESTORLIN® FREE-GEAR® MANUAL TRANSMISSION SYNTHETIC GEAR LUBRICANT

Part#	Desc.	Price
KE-965	75W/75 Qt.	\$15.03
KE-975	75W/80 Qt.	\$15.03
KE-980	75W/90 Qt.	\$15.03
KE-990	80W/90 Qt.	\$15.03
KE-994	75W/140 Qt.	\$15.03
KE-995	75W/110 Qt.	\$15.03

Also available by the Case & 5 Gallon Pail

Additives & Aerosols

	Part #	Size	Price
Assembly Lube	KL-311	12oz	\$8.99
Fogon - Storage & Afterrun Lubricant	KL-612	6oz	\$5.36
.....	KL-610	16oz	\$7.34
Foam Air Filter Oil	KL-606	15.25oz	\$8.44
Fabric Air Filter Oil	KL-607	15.25	\$8.04
Air Filter Cleaner.....	KL-608	15.25oz	\$8.95
Plug & Contact Cleaner.....	KL-609	12.5oz	\$9.22
Ethanol Gasoline Fazeseperation Treatment.....	KL-603	16oz	\$9.75
Storbilizer	KL-613	16oz	\$10.25
Cometic Engine Block & Head Surface Cleaner.....	C1047	15.25oz	\$9.95





UTV Gaskets

ARCTIC CAT UTV

Model	Year	Bore Size	Top End Kit	List Price	Component Part#	Component Description	List Price	OEM Part #
Prowler 650	06-09	98 mm	C7220	\$65.93	H1735SP3027S	Head Gasket 98mm Bore	\$35.72	0830-124
		100 mm	C7022	\$65.93	H1735SP4027S	Head Gasket 100mm Bore	\$35.72	0830-124
					B0647014RC	Base Gasket	\$6.19	0830-084
					EX657	Exhaust Gasket	\$9.37	0412-338
					EC377032AFM	Cam Chain Tens. Gasket	\$3.35	0830-018
					OS020	2 Req.-Cam Chain Tens. O-ring	\$1.03	0830-107
					R22X2.5V	Coolant Line O-ring	\$2.21	0830-007
					R45X3V	Intake O-ring	\$2.71	0830-090
					R54X2V	2 Req.-Valve Cover O-rings	\$4.14	0830-004

Bottom End Gaskets Available Separately

Component Part#	Component Description	List Price	OEM Part #
EC1142032AFM	Clutch Cover Gasket	\$30.95	0830-116
EC1143032AFM	Magneto Cover Gasket	\$24.98	0830-128
EC1141032AFM	Primary Cover Gasket	\$35.72	0830-174

Model	Year	Bore Size	EST Top End Kit	List Price	Component Part#	Component Description	List Price	OEM Part #
Prowler 700 XT LTD	08-15	103.5mm	C3597-EST	\$65.93	H2223SP4027S	Head Gasket	\$26.52	0830-112
					B0760014RC	Base Gasket	\$5.54	0830-111
HDX700	11-17				EX657	Exhaust Gasket	\$6.19	0412-338
					OS020	Cam Chain Tensioner Gasket	\$1.03	0830-107
					EC377032AFM	Cam Chain Tens. Gasket	3.35	0830-018
					3186V	Valve Seals	\$4.99	0830-186
					R22X2.5V	Water Outlet O-ring	\$2.21	0830-007
					R124V	Valve Cover O-rings 2 req.	\$1.19	0830-215
					R008B	Intake O-ring	\$0.11	0423-182
					R124V	Oil Fill Cap O-ring	\$1.19	0830-215
					R54X2V	Inspection Cap O-ring	\$4.14	0830-004

Bottom End Gaskets Available Separately

Component Part#	Component Description	List Price	OEM Part #
EC1142032AFM	Clutch Cover Gasket	\$30.95	0830-116
EC1143032AFM	Magneto Cover Gasket	\$24.98	0830-128
EC1141032AFM	Primary Cover Gasket	\$35.72	0830-174

Model	Year	Bore Size	EST Top End Kit	List Price	Component Part#	Component Description	List Price	OEM Part #
Prowler/ Wildcat 1000	10-17	93.5mm	C3568-EST	\$126.58	H2399SP6027S	Head Gasket	\$30.58	0830-209
					B1155014RC	Base Gasket	\$19.61	0830-193
					EX657	Exhaust Gasket	\$0.00	0412-338
					EC2035032AFM	Cam Chain Tensioner Gasket 2 Req.	\$3.35	0830-134
					3186V	Valve Seals 8 Req.	\$4.99	0830-186
					R118V	Water Outlet O-ring	\$1.13	0830-007
					OS384	Water Inlet Seal	\$5.08	0830-120
					R54X2V	Valve Cover O-rings 4 req.	\$4.14	0830-004
					R45X3V	Intake O-ring 2 req.	\$2.71	0830-090

CAN-AM/BOMBARDIER UTV

Model	Year	Bore Size	EST Top End Kit	List Price	Component Part#	Component Description	List Price	OEM Part #
Commander 1100	11-16	92mm	C3459-EST	\$155.00	H2653018S	Head Gasket 92mm 2 Req.	\$44.55	420630195
		93mm	C3460-EST	\$155.00	H2653SP1018S	Head Gasket 93mm 2 Req.	\$44.55	
Maverick 960	13-15	94mm	C3461-EST	\$155.00	H2653SP2018S	Head Gasket 94mm 2 Req.	\$44.55	
		96mm	C3462-EST	\$155.00	H2653SP5018S	Head Gasket 95mm 2 Req.	\$44.55	
					3186V	Valve Stem Seal 8 Req.	\$4.99 ea.	420230515
					R117V	Cam Chain Tensioner O-ring	\$1.19	420430370
					R15X1.5V	Cam Adjuster O-ring	\$1.13	420250890
					EX696	Header Gasket 2 Req.	\$10.28	707600317
					B0895010RC	Base Gasket 2 Req.	\$15.24	420630210

Bottom End Gaskets Available Separately

Component Part#	Component Description	List Price	OEM Part #
EC1142032AFM	Clutch Cover Gasket	\$30.95	0830-116
EC1143032AFM	Magneto Cover Gasket	\$24.98	0830-128
EC1141032AFM	Primary Cover Gasket	\$35.72	0830-174

HONDA UTV

Model	Year	Bore Size	Top End Kit	List Price	Component Part#	Component Description	List Price	OEM Part #
FL250 Odyssey	73-77	72 mm	C7140	\$25.55	H0182043F	Head Gasket 72mm	\$19.28	12251-358-306
					B0137020F	Base Gasket 73-76	\$6.25	12191-357-306
					B0395020F	Base Gasket 77-84	\$5.34	12191-381-306
FL350R Odyssey	85	82 mm	C7229	\$31.91	B0204020F	Base Gasket	\$7.16	12191-VMO-772
					H0344043F	Head Gasket	\$22.32	12254-VMO-013



UTV Gaskets

HONDA UTV

Model	Year	Bore Size	Top End Kit	List Price	Component Part#	Component Description	List Price	OEM Part #
Pilot	89-91	82 mm	C7024	\$35.72	H0015043F	Head Gasket	\$22.32	12251-HE0-000
FL-400					B0020020F	Base Gasket	\$6.25	12191-HE0 000/010
					EX009042AM	Exhaust Gasket	\$4.65	18291-HE0 000/010
					IR004018AFM	Intake Gasket	\$3.80	14132-KAE- 000/430-000

KAWASAKI UTV

Model	Year	Bore Size	EST Top End Kit	List Price	Component Part#	Component Description	List Price	OEM Part #
KRF750	08-14	85mm	C3284-EST	\$122.60	H2624SPA010S	Head Gasket 85mm	\$28.29	11004-0011
Teryx (SXS)		90 mm	C3251-EST	\$122.60	H2624SP1010S	Head Gasket 90mm	\$28.29	11004-0011
					B0951020RC	Base Gasket	\$9.94	11061-0063
					EX361	Exhaust Gasket 2 req	\$5.50	11009-1894
					WA114	Coolant Drain Washer 2 Req	\$3.02	
					R55X2V	Rocker Cap O-Ring 4 Req	\$2.34	92055-0112
					R19X2V	Plug Cover O-Ring 2 Req	\$2.50	92055-1146
					3242V	Valve Stem Seals 8 Req	\$3.02	92049-1218

POLARIS UTV

Model	Year	Bore Size	EST Top End Kit	List Price	Component Part#	Component Description	List Price	OEM Part #
RZR170	09-16	61mm	C3596-EST	\$49.84	B1318020RC	Cylinder Base Gasket	\$2.17	0454459
					H4194010S	Cylinder Head Gasket	\$19.99	0454365
					IR1308020F	Intake Manifold Gasket	\$2.95	0453451
					R024V	Intake Manifold O-ring	\$1.19	0452459
					R049B	Cylinder Head Cover O-ring	\$2.97	0454363
					EC2131032AFM	Cylinder Head Breather	\$4.79	0454640
					EC2132060AFM	Air Injection Gasket	\$2.39	0452808
					EC2133060AFM	Air Injection Tube Gasket	\$2.39	0454454
					EX886042AM	Exhaust Gasket	\$4.30	0453672
					3234V	Valve Seal	\$5.50	0452390
					EC2134032AFM	Cam Chain Tensioner Gasket	\$1.24	0452417

Model	Year	Bore Size	EST Top End Kit	List Price	Component Part#	Component Description	List Price	OEM Part #
RZR 570	12, 14-18	99mm	C3528-EST	\$79.02	B1171014RC	Base Gasket	\$19.29	5254903
					H3609021S	Head Gasket 99mm Bore	\$34.27	5813676
					3231V	Valve Seals 4 Req.	\$6.48 ea.	3610161
					3254V	Valve Spring Seat w/Seal	\$5.21	3610212
					EX817	Exhaust Gasket	\$11.28	5253989
					EC1654020RC	Cam Chain Tensioner	\$3.52	5813449

Model	Year	Bore Size	Top End Kit	List Price	Component Part#	Component Description	List Price	OEM Part #
Ranger	08	80 mm	C3250	\$70.96	H2761030S	Head Gasket 80mm Bore	\$51.73	5247359
RZR 800 (SXS)		82 mm	C3507	\$70.96	H2761SP2030S	Head Gasket 82mm Bore	\$51.73	
					B0940010RC	Base Gasket	\$11.60	5247360
					EX452SP1064AM	Exhaust Gasket	\$15.51	5811511

Model	Year	Bore Size	Top End Kit	List Price	Component Part#	Component Description	List Price	OEM Part #
Ranger	11-13	80 mm	C3506	\$70.96	H3657010S	Head Gasket 80mm Bore	\$51.73	5254357
RZR 800 (SXS)		82 mm	C3508		H3657SP2010S	Head Gasket 82mm Bore	\$51.73	
					B0940010RC	Base Gasket	\$11.60	5247360
					EX452SP1064AM	Exhaust Gasket	\$15.51	5811511

Model	Year	Bore Size	EST Top End Kit	List Price	Component Part#	Component Description	List Price	OEM Part #
XP900	11-14	93.5mm 96mm	C3446-EST C3447-EST	\$85.66 \$85.66	H3336018S	Head Gasket 93.5mm Bore	\$34.27	5813439
					H3336SP1018S	Head Gasket 93.5mm Bore	\$34.27	
					B1079014RC	Base Gasket	\$19.29	5253037
					EC1654020RC	Cam Chain Tensioner	\$3.52	5813449
					WP383032AFM	Water Inlet Gasket	\$3.74	5813521
					EX817	Exhaust Gasket 2 req.	\$11.28	5253989
					3231V	Valve Seals 8 Req.	\$6.48 ea.	3610161

Model	Year	Bore Size	EST Top End Kit	List Price	Component Part#	Component Description	List Price	OEM Part #
RZR XP 1000	14-19	94mm 96mm	C3546-EST C3563-EST	\$85.66 \$85.66	H3892018S	Cylinder Head Gasket 94mm Bore	\$34.27	5813737
					H3892SP1018S	Cylinder Head Gasket 96mm Bore	\$34.27	5813737
RZR XP 4 1000	14-19				B1079014RC	Base Gasket	\$19.29	5253037
					EC1654020RC	Cam Chain Tensioner Gasket	\$3.52	581344
900 ACE General 1000	16-19				EX1408064AM	Header Gasket	\$12.20	3610184
					3254V	Valve Spring Seat With Seal	\$5.21	3610212
					MR135	Thermostat Seal	\$4.00	5413948
Ranger 1000	18-19				MR136	Water Outlet O-ring	\$10.99	5813736

Model	Year	Bore Size	EST Top End Kit	List Price	Component Part#	Component Description	List Price	OEM Part #
RZR 1000 Turbo	16-19							



UTV Gaskets

YAMAHA UTV

Model	Year	Bore Size	EST Top End Kit	List Price	Component Part#	Component Description	List Price	OEM Part #
RHINO 660 (SXS)	04-07	100 mm	C7044-EST	\$89.44	H1481SP2030S	Head Gasket 100mm	\$27.26	3YF-11181-00
		101 mm	C7900-EST	\$89.44	H1481030S	Head Gasket 101mm	\$27.26	
		102 mm	C7798-EST	\$89.44	H1191030S	Head Gasket 102mm	\$27.26	
		103 mm	C3042-EST	\$89.44	H2174030S	Head Gasket 103mm	\$27.26	
		105 mm	C7909-EST	\$89.44	H1191SP1030S	Head Gasket 105mm	\$27.26	
					B0532010RC	Base Gasket	\$8.69	3YF-11351-00
					EX361	Exhaust Gasket 2 Req.	\$5.50	3YF-14613-01-00
					EC584018AFM	Cam Chain Tensioner Gasket	\$3.58	4DW-12213-00
					3187V	Valve Seal 5 Req.	\$3.02	5H0-12119-00-00
					R016B	Radiator Hose O-ring	\$0.74	93210-18417-00
					R113B	Valve Cover Plug O-ring	\$1.19	93210-13657-00
					R114S	Oil Tank O-ring	\$3.92	93210-16629-00
					R116B	Cam Chain Tensioner Cap O-ring	\$1.13	11101/93210-19522-00
					R117B	Dipstick O-ring	\$0.42	93210-21190-00
					R124B	Tappet Cover O-ring	\$3.92	93210-32172-00
					R155S	Cylinder Base O-ring	\$3.92	11256/93211-01467-00
					R71X2.5B	Intake Valve Adj. Cover O-ring	\$2.57	93210-71360-00
					WA081080C	Oil Line Washers 4 Req.	\$0.57	90430-08204
					WA082063C	Oil line Washers 4 Req.	\$1.93	90430-10171
			EST Top End Kit	List Price	Component Part#	Component Description	List Price	OEM Part #
RHINO 700	06-13	103 mm	C3142-EST	\$89.44	H2449027S	Head Gasket	\$40.55	3B4-11181-00-00
		104 mm	C3143-EST	\$89.44	H2449SP2027S	Head Gasket 104mm Bore	\$40.55	3B4-11181-00-00
		105.5 mm	C3144-EST	\$89.44	H2465027S	Head Gasket 105.5mm Bore	\$40.55	3B4-11181-00-00
					B0855010RC	Base Gasket	\$9.47	1S3-11351-00-00
					EX361	Exhaust Gasket 2 Req.	\$5.50	3YF-14613-01-00
					R034V	Throttle Body O-ring	\$3.00	4WV-14147-10-00
					R126V	Water Pump O-ring	\$1.19	93210-33786-00
					R131B	Thermostat O-ring	\$1.13	93210-41042-00
					R240V	Cam Cover O-ring	\$3.92	93210-96601-00
					R79X2.5V	Valve Cover O-rings 2 Req.	\$7.29	93210-78544-00
					3187V	Valve Seal 4 Req.	\$3.02	5H0-12119-00-00
					EC584018AFM	Cam Chain Tensioner Gasket	\$3.58	4DW-12213-00
			EST Top End Kit	List Price	Component Part#	Component Description	List Price	OEM Part #
Wolverine Spec YXE700	2016	103mm	C3599-EST	\$64.58	EC2098032AFM	Cam Chain Tensioner Gasket	\$2.46	2MB-E2213-00-R-00
					MA0164	Cam Chain Tensioner Crush Gasket	\$0.93	2MB-E21E2-00-00
					B1306010RC	Cylinder Base Gasket	\$9.47	2MB-E1351-00-00
					H4173023S	103mm Bore Head Gasket	\$40.55	2MB-E1181-00-00
					VC362018AFM	Valve Cover Breather Gasket	\$4.02	2MB-E131B-00-00
					EX045	Header Gasket	\$4.26	3EG-14613-00-00
					WA117	Oil Line Banjo Bolt Crush Gaskets	\$0.95	2MB-E1195-00-00
					3187V	Exhaust Valve Seal	\$1.48	2MB-E2129-00-00
					3187V	Intake Valve Seal	\$1.48	2MB-E2119-00-00
					R125V	Water Outlet O-ring	\$1.19	2MB-E2843-00-00
			Top End Kit	List Price	Component Part#	Component Description	List Price	OEM Part #
YXZ1000R	2016	82.5mm	C3617	\$100.55	EC1152032AFM	Cam Chain Tensioner Gasket	\$2.33	2C0-12213-00-00
					R116B	Fill Plug O-ring	\$1.13	93210-19123-00
					WA116	Cylinder Head Drain Plug Crush Washer	\$1.06	90430-08119-00
					H4270016S	Cylinder Head Gasket	\$62.63	2HC-11181-00-00
					EX651	Exhaust Gasket 3 Req	\$8.98	4FM-14613-00-00
					3168V	Valve Stem Seal 12 Req.	\$1.47	2HC-12119-00-00

WARRANTY DISCLAIMER*

Due to the nature of performance applications, the parts in this catalog are sold without any express warranty or any implied warranty of merchantability or fitness for a particular purpose. Comet Gasket Inc. shall not, under any circumstances, be liable for any special, incidental or consequential damages, including, person, party or property, but not limited to, damage, or loss of property or equipment, loss of profits or revenue, cost of purchased or replacement goods, or claims of customers of the purchase, which may arise and/or result from sale, installation or use of these parts. Installation of these parts could adversely affect the motor manufacturers warranty coverage.

VENUE-The agreed upon venue, in the event of any dispute whatsoever between the parties, whether instituted by either party, including, but not limited to, contract terms, payment terms, delivery, type, defects, sufficiency of product, shall be the Court of Common Pleas, Lake County, Ohio or the Painesville Municipal Court, Lake County, Ohio, depending on the amount in controversy. This agreement shall be governed by and construed under the laws of the State of Ohio.

All prices and terms are subject to change without notice.

Terms Open accounts may be established by well rated firms. A credit application is available upon request. Open accounts are due payable Net 30 days from date of invoice. No statement will be sent. If an account becomes 60 or more days past due, it is subject to being placed on credit hold. No orders will be shipped or new orders accepted until past due balance is paid. If an account becomes 90 or more days past due, it is subject to being placed for collections. All costs of collection are the responsibility of the customer, including attorney fees, court costs, and other expenses of litigation.

Returns- Authorization (RGA) must be obtained in advance on all returns. A packing slip or invoice number must accompany the merchandise. No returns after 30 days from invoice date. All returns are subject to a 25% restocking charge. All custom designed and custom manufactured gaskets are non-returnable. Only catalog parts are returnable.

Review your invoice and notify us immediately of any incorrect or inaccurate information. Shortages must be reported within 10 days.



Fasteners



Fuel Injector O-Ring Set

Application	Desc.	Part #
1986+ Ford/GM	Pack of 8	C15383

Flex Plate Bolt Kit

Application	Desc.	Part #
GM V6/SB, Gen 1/BB, Mark 4 BB, SB	Grade 8 7/16" - 20 x 11/16" & Washers Qty. 6	CF1007

Harmonic Balancer Bolt Kit

Application	Desc.	Part #
GM SB Gen 1	Grade 8 7/16-20 x 2 1/4" Bolt & 2 Washers	CF1008

Air Cleaner Stud Kit

Application	Desc.	Part #
Universal	5/16" Stud & Wing Nut	CF1014

Carb Stud Fasteners

Application	Desc.	Part #
Universal	1.5" Zinc Plated 4 Studs/Nuts/Washers	CF1000
Universal	2" Zinc Plated 4 Studs/Nuts/Washers	CF1001
Universal	2.5" Zinc Plated 4 Studs/Nuts/Washers	CF1002
Universal	2" Bullet Tip 4 Studs/Nuts/Washers	CF1005

Header Bolt Kits Fastners

Application	Desc.	Part #
GM Gen 1 SB	Black Oxide Hex Head 3/8-16 x 3/4" Bolts w/Tool Qty.12	CF1009
Universal	Black Oxide 3/8-16 x 1" Grade 5 Qty.12	CF1012
GM LS & LSX	Black Oxide M8-1.25 x 25MM Qty.12	CF1013

Torque Converter Bolt Kit

Application	Desc.	Part #
Chevy TH350 / Powerglide	Grade 8 3/8-24 x 5/8" Bolts Qty. 3	CF1003

Intake Manifold Bolt Kit

Application	Desc.	Part #
GM V6/SB Gen 1	Grade 8 12pt Zinc Plated 3/8-16x1" Qty.12	CF1010
GM V6/ SB Gen 1	Grade 5 6pt Zinc Plated 3/8-16x1" Qty.12	CF1011



Product Development

Cometic provides our customers with quality products, born of exhaustive research and development. Cometic's Superflow 902S dynamometer positions us at the forefront of gasket design and technology. Our state-of-the-art testing facilities and processes provide Cometic with the resources necessary to analyze gasket designs and materials in the most extreme conditions, ensuring that your gasket won't fail when you need it the most.

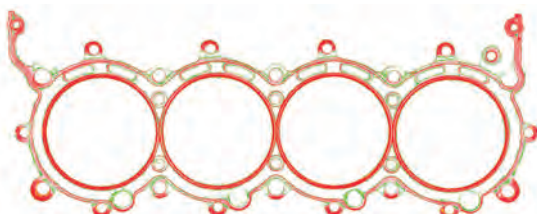
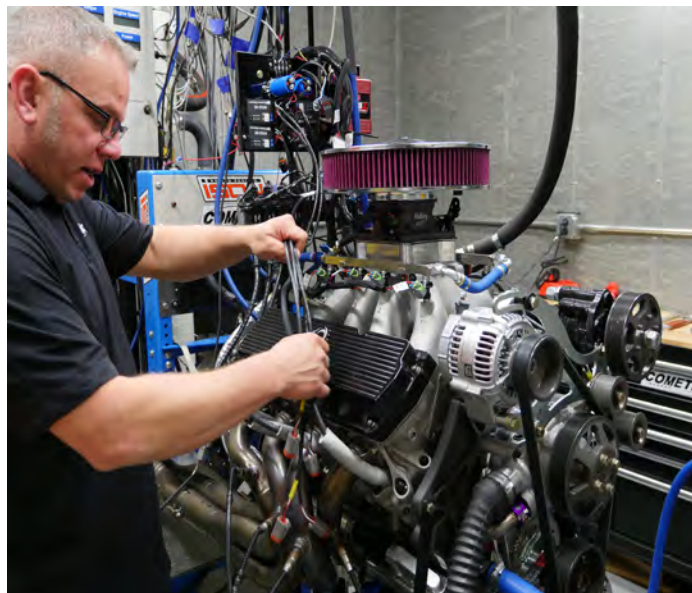

Gasket contact pressure is validated by Fuji film at our in-house research and development center.



Made in the U.S.A.

OEM Production

One Source for Prototyping to Full Production

- Prototyping with economical tooling options.
- Full production Capabilities
- Quick turnaround
- In-house tool & die capabilities
- ISO 9001:2008 Certified
- We can assist in developing a sealing solution for nearly any environment.
- Personal attention by our dedicated staff. We currently supply production to many customers in the automotive, marine, powersports, industrial, and power generator industries.
- Stamping, Laser Cutting, Rubber Injection Molding and 5 Axis Machining

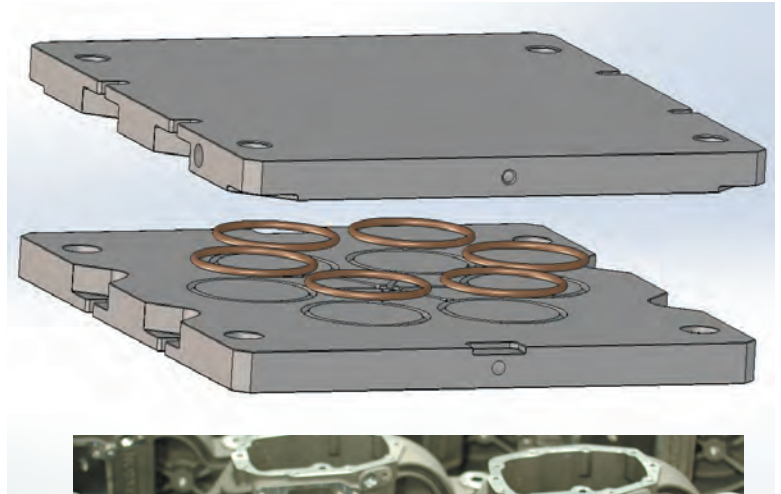

Flexibility is Key

We understand many variables go into determining design, volume, and production forecasts. We are accustomed to working in an ever changing environment.

Maintain knowledge base and part awareness during the transition from the early stages of development all the way through production, without the hassle of changing suppliers.

Inventory turns are important. We can work together for a delivery solution that best fits your inventory level and cash flow needs.



Call our Engineering Team today @ (440) 354-0777 for a quote